

**KONG HWA SCHOOL
TOPICAL TEST ONE 2011
MATHEMATICS
PRIMARY ONE**

Name: _____ ()

Marks:

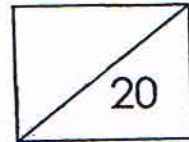

Class: Pr 1 (_____)

Date: 12 July 2011

Duration: 45 minutes

Parent's Signature: _____

Section A (14 x 1 = 14 marks)

Do Questions 1 to 14 carefully.

1. Write a **subtraction sentence** based on the picture below.

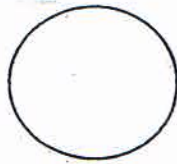
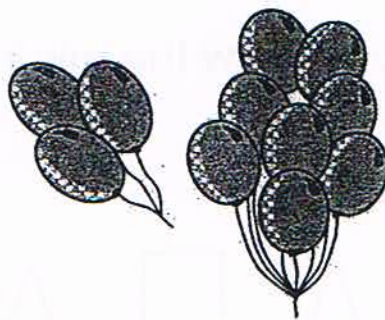

=



2. Write the number **in words**.

13	
----	--

3. 18 is _____ more than 12.

4. $17 + 2 = \underline{\quad\quad} + 8$

5. Look at the pattern below. **Draw** the missing shape.

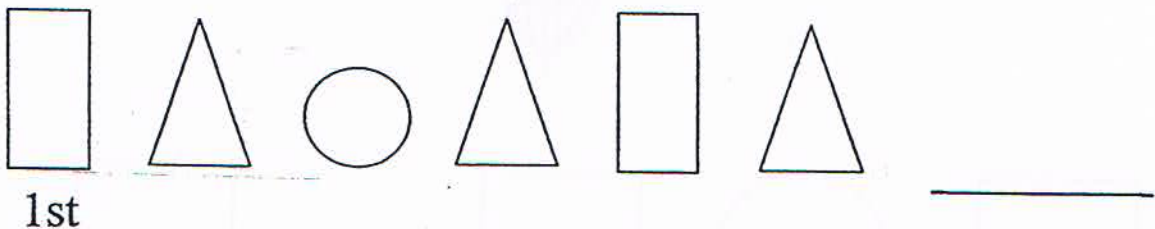

6. Ring the 5th strawberry.

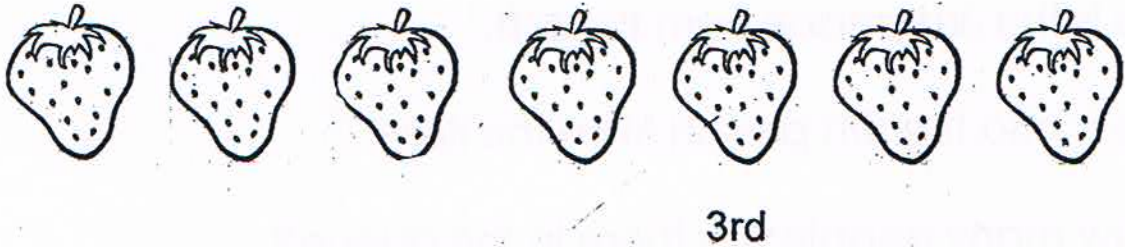

7. Look at the pattern below.

How many dots are there in the box ?

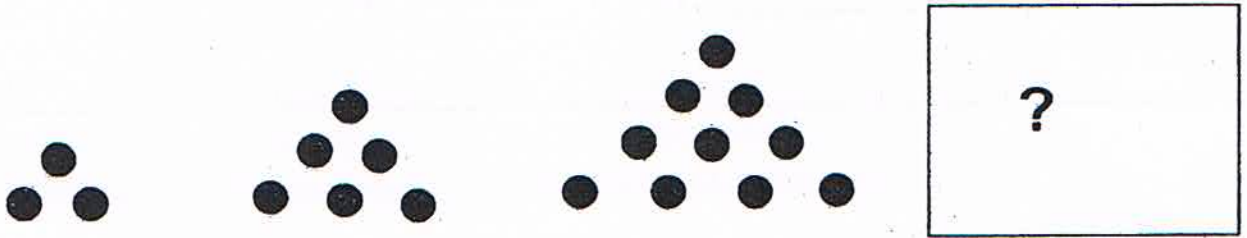

There are _____ dots in the box.

8.

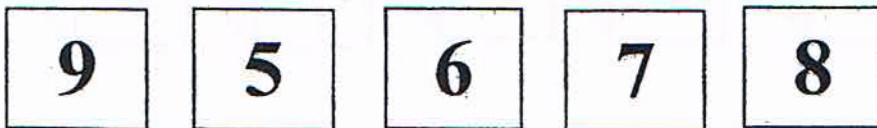

The sum of 2 numbers above make 17.

The 2 numbers are _____ and _____.

9. Roy is queueing up to buy an ice-cream.

He is the 3rd person from the left.

He is also the 4th person from the right.

How many people are there in the queue?

There are _____ people in the queue

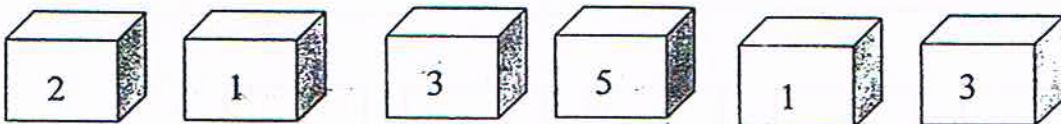

10. Add up all the numbers **from** the 2nd **to** the 5th box from the **right**.

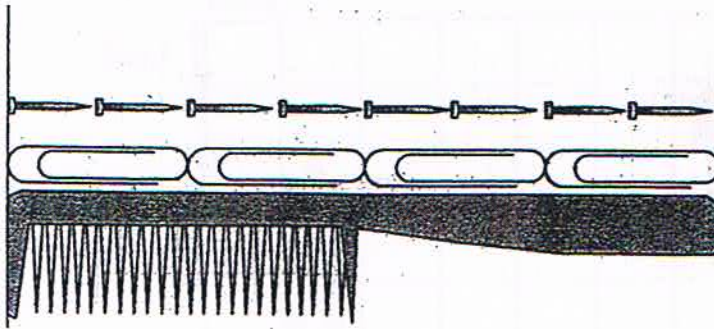

The sum of the numbers is _____

Study the picture below and answer Questions 11 and 12.



11. The length of  is about _____  long.

12. The length of  is about _____  long.

Study the picture below and answer Questions 13 and 14.

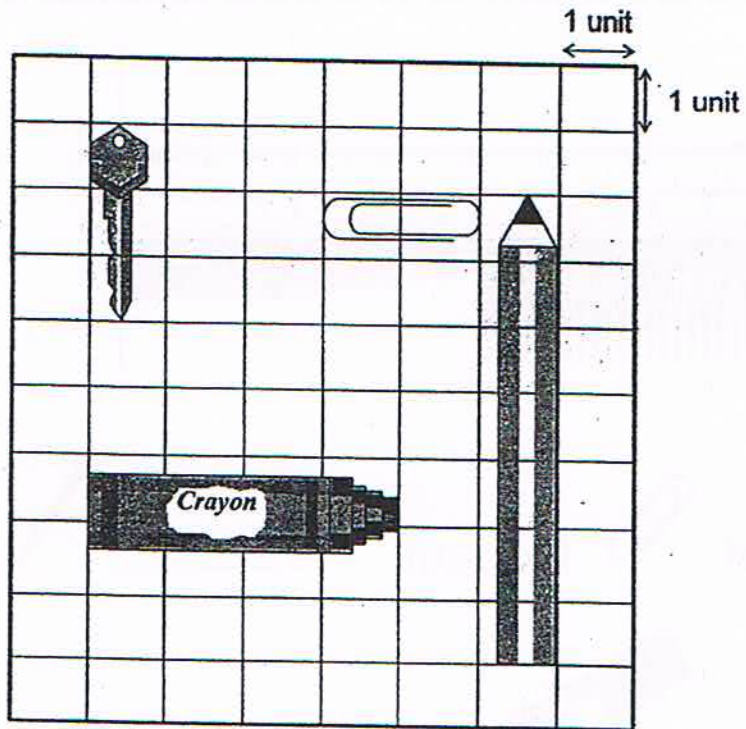

13. The total length of all the objects is _____ units.

14. The crayon is _____ units shorter than the pencil.

Section B (2 X 3 = 6 marks)

Do these sums carefully. Show your working clearly.

15. There are 19 birds on a tree.

4 birds flew away.

How many birds are left on the tree?

$$\square \quad \bigcirc \quad \square = \square$$

There are _____ birds left on the tree.

16. After John ate 3 cookies, there were 15 cookies left in the jar. How many cookies were there in the jar at first?

$$\square \quad \bigcirc \quad \square = \square$$

There were _____ cookies in the jar at first.

End - of - Paper

Please remember to check your answers.



ANSWER SHEET

EXAM PAPER 2011

SCHOOL : KONG HWA
SUBJECT : PRIMARY 1 MATHEMATICS

TERM : TEST 1

1) $11 - 3 = 8$ 2) thirteen 3) 6 4) 11 5)

6)  7) 15 8) 9 and 8 9) 6 10) 10

11) 2 12) 8 13) 16 14) 3

15) $19 - 4 = 15$
There are 15 birds left on the tree.

16) $15 + 3 = 18$
There were 18 cookies in the jar at first.