

Anglo-Chinese School (Junior)



SEMESTRAL ASSESSMENT 2 (2016)

PRIMARY 4

SCIENCE

BOOKLET A

Thursday

3 November 2016

1 hr 30 min

Name: _____ () Class: 4.()

INSTRUCTIONS TO PUPILS

- 1 Do not turn over the pages until you are told to do so.
- 2 Follow all instructions carefully.
- 3 There are 25 questions in this booklet.
- 4 Answer ALL questions.
- 5 Shade your answers in the Optical Answer Sheet (OAS) provided.

Booklet A (50 marks)

For each question from 1 to 25, four options are given. One of them is the correct answer. Make your choice (1, 2, 3 or 4). Shade your answer on the Optical Answer Sheet. (25 x 2 marks)

1. Matter is anything that has mass and occupies space.

Which of the following is **NOT** matter?

- (1) Soil
- (2) Light
- (3) Wind
- (4) Water

2. Which statement is true about most mammals?

- (1) They can swim.
- (2) They have wings.
- (3) They produce milk.
- (4) They have four legs.

3. The diagram below shows a young plant.



The leaf helps the plant to _____.

- (1) make food
- (2) grow upright
- (3) absorb water
- (4) absorb nutrients

4. A, B, C and D are the various stages in the life cycle of a mosquito.

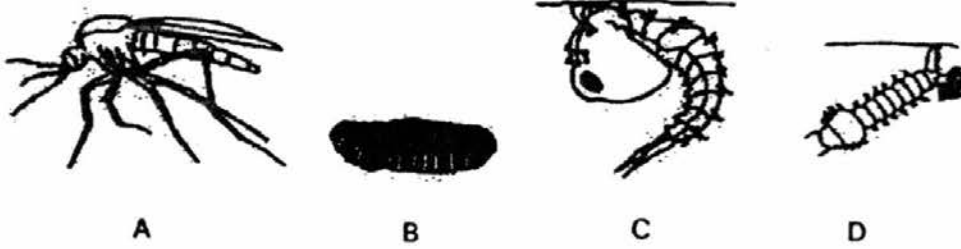

Which of the following correctly shows the life cycle of a mosquito?

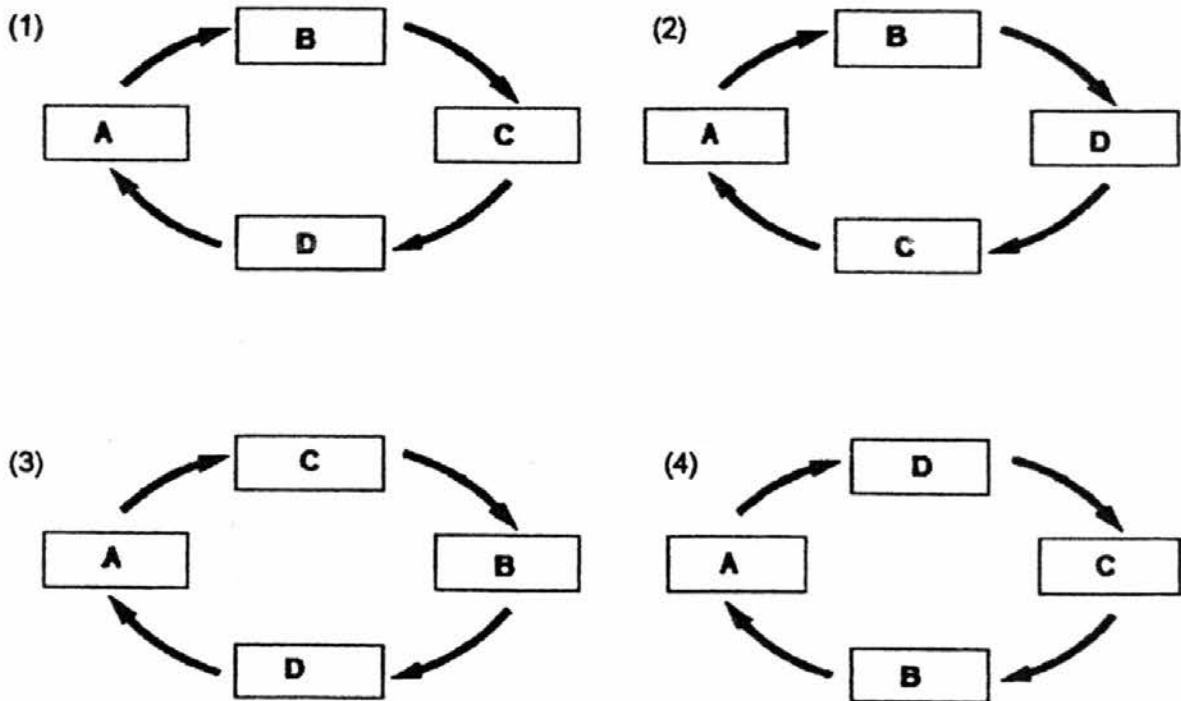

5. Look at the picture below.

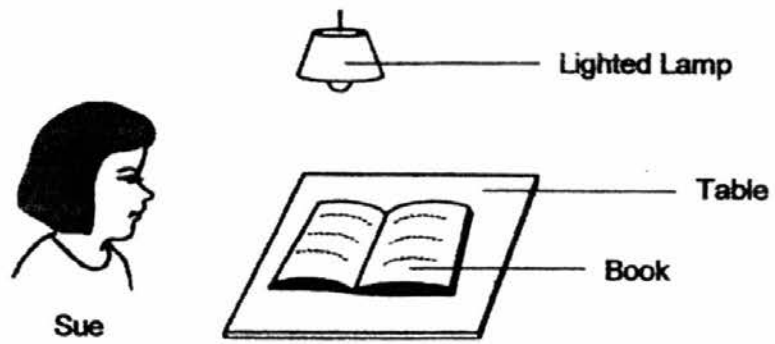

Which one of the following explains why Sue can see the book on the table?

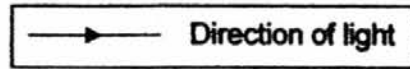

(1)

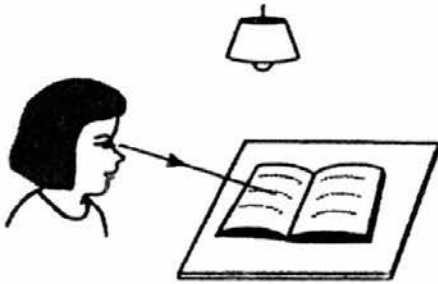

(2)

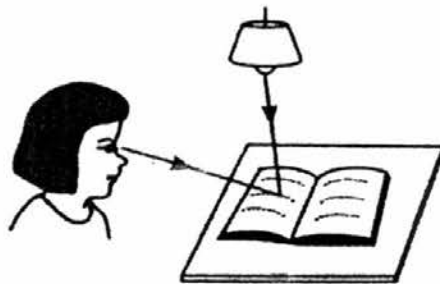

(3)

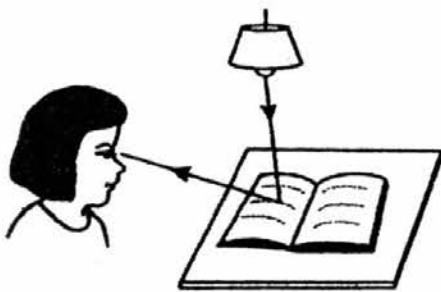

(4)



6. Which one of the following shows the correct order when food moves through some parts of the digestive system?

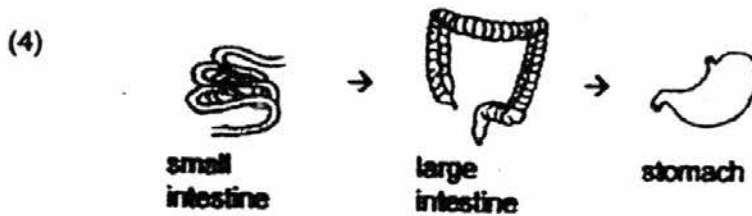
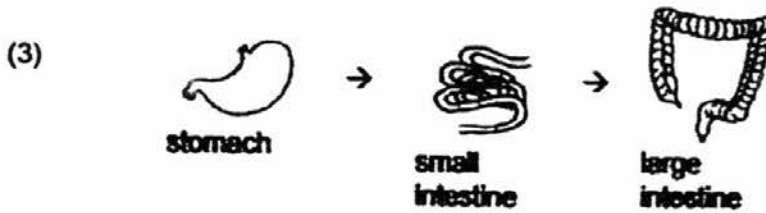
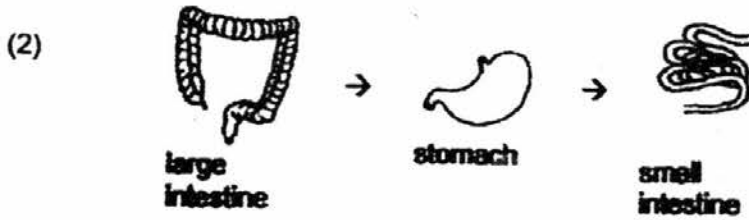
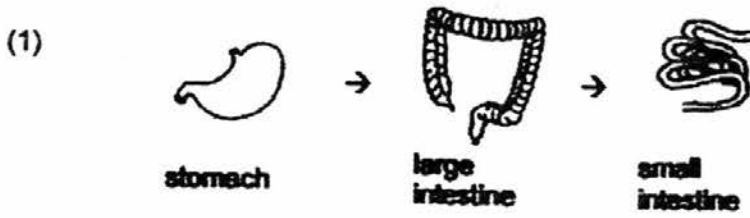

7. Which one of the following is a living thing?

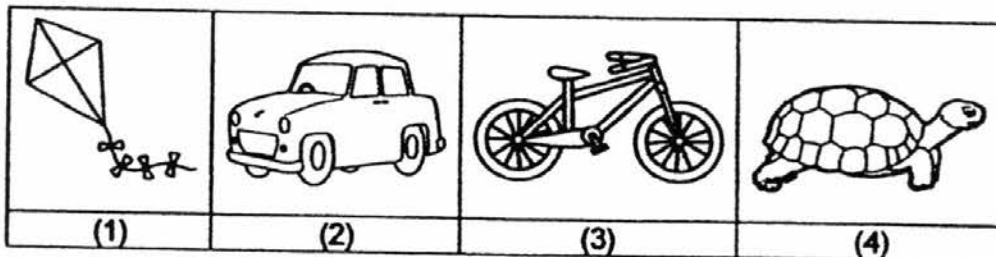

8. Which one of the following can be attracted by a magnet?

- (1) Steel ball
- (2) Plastic ball
- (3) Rubber ball
- (4) Wooden ball

9. Which of the following statements are true about ^{most} ~~all~~ fungi?

- A Fungi can make its own food.
- B Fungi reproduce from spores.
- C Fungi needs air, food and water to survive.
- D Fungi can only be seen with a microscope.







- (1) A and D only
- (2) B and C only
- (3) A, B and D only
- (4) A, C and D only

10. Which of the following can be put into a 60 cm^3 container and closed with a lid?

- A 70 cm^3 of air
- B 70 cm^3 of sand
- C 65 cm^3 of water
- D 65 cm^3 of sponge

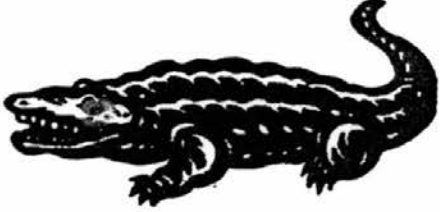
- (1) A and C only
- (2) A and D only
- (3) B and D only
- (4) All of the above

11. Sue grouped some things as shown below.

Group A	Group B
 <p data-bbox="501 607 564 637">Snail</p>  <p data-bbox="475 879 571 909">Dolphin</p>  <p data-bbox="475 1165 596 1195">Crocodile</p>	 <p data-bbox="1018 614 1070 644">Nail</p>  <p data-bbox="970 864 1107 893">Spectacles</p>  <p data-bbox="938 1204 1075 1233">Frying pan</p>

How did she group them?

She grouped them according to _____.

- (1) the way they move
- (2) the shape of their bodies
- (3) whether they can reproduce
- (4) the materials that they are made of

12. Why are seed leaves important to a seedling?

- (1) They are part of its roots.
- (2) They will develop into leaves.
- (3) They form part of the developing stem.
- (4) They provide food for the seedling before the leaves develop.

13. Which of the following are functions of the skeletal system in a human body?

- A To give the body shape,
- B To support the human body.
- C To protect the organs in the body,
- D To absorb digested food into the blood.

- (1) A and B only
- (2) C and D only
- (3) A, B and C only
- (4) A, B, C and D

14. The diagram shows the sequence of growth of a green bean plant.

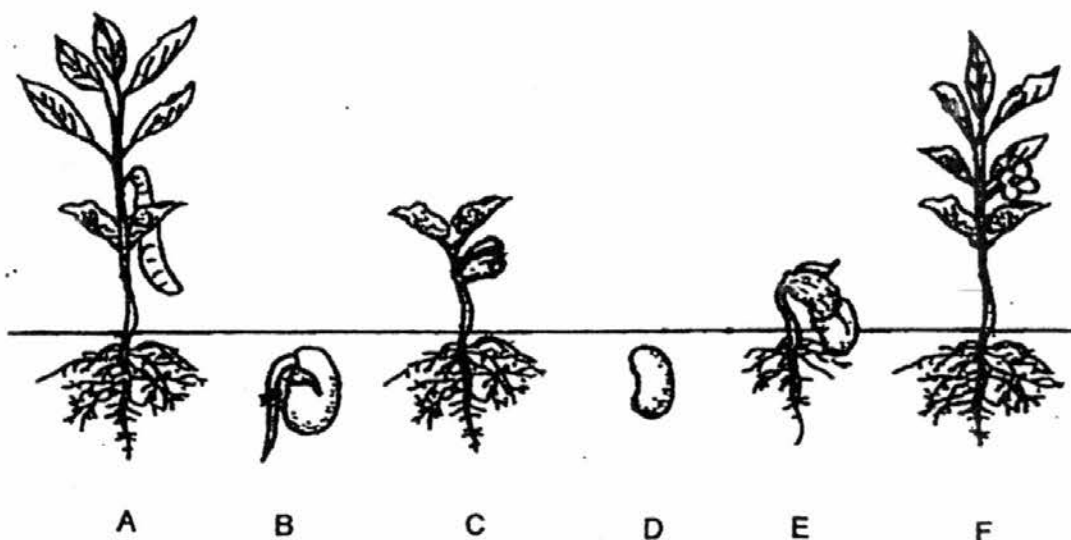

Which of the following shows the correct sequence of growth of a green bean seed into a plant?

- (1) A → F → C → E → B → D
- (2) F → A → B → D → E → C
- (3) D → B → E → C → F → A
- (4) B → E → C → F → D → A

15. The diagram below shows the life cycle of a butterfly.

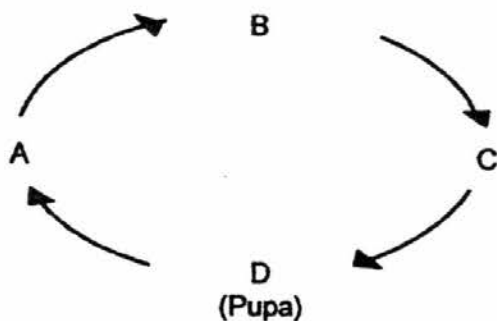

At which stage A, B, C or D, does the butterfly cause the most harm to plants?

- (1) A
 - (2) B
 - (3) C
 - (4) D
16. Melvin used the same amount of water to make two identical ice blocks. The ice blocks were placed on 2 identical dishes A and B. The ice block on Dish B was cut into smaller pieces.

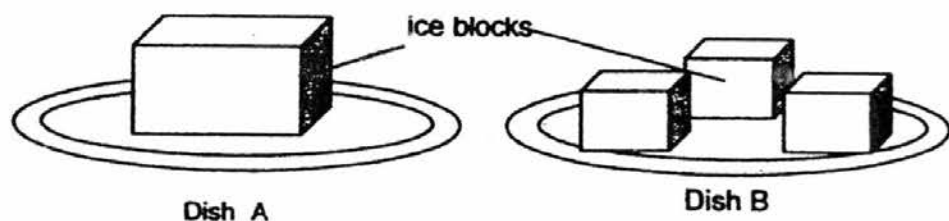

Which one of the following statements is correct?

- (1) The ice block in Dish A has a greater mass than the ice blocks in Dish B.
- (2) The ice block in Dish A has a greater volume than the ice blocks in Dish B.
- (3) The ice block in Dish A occupies the same space as the ice blocks in Dish B.
- (4) The ice block in Dish A is smaller in size compared to the ice blocks in Dish B.

17. Max made a cube out of plasticine and put it into a beaker of water. The water level rises from 100ml to 150ml.

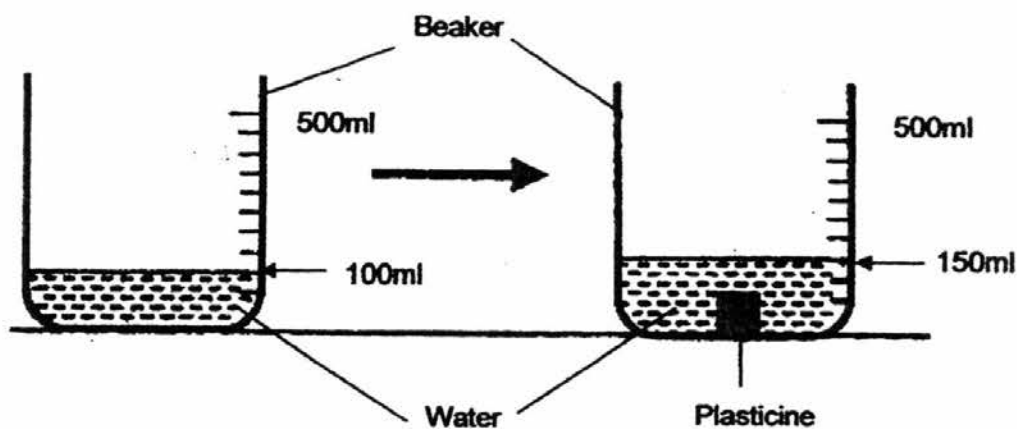

He took the plasticine out of the beaker and rolled it into a ball. Then he placed it into another beaker containing 100ml of water.

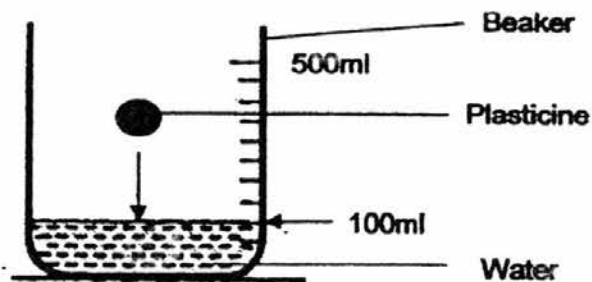

What is the water level of the beaker after the ball is placed into the beaker of water?

- (1) 100ml
- (2) 130ml
- (3) 150ml
- (4) 170ml

18. Christine set up an experiment to find out the magnetic strength of 4 magnets, P, Q, R and S. She first placed the magnets at equal distances away from the paper clips. She then moved each magnet slowly towards the paper clip and stopped when the paper clip got attracted to it. The diagrams below show the start and the end of the experiment.

At the start of the experiment

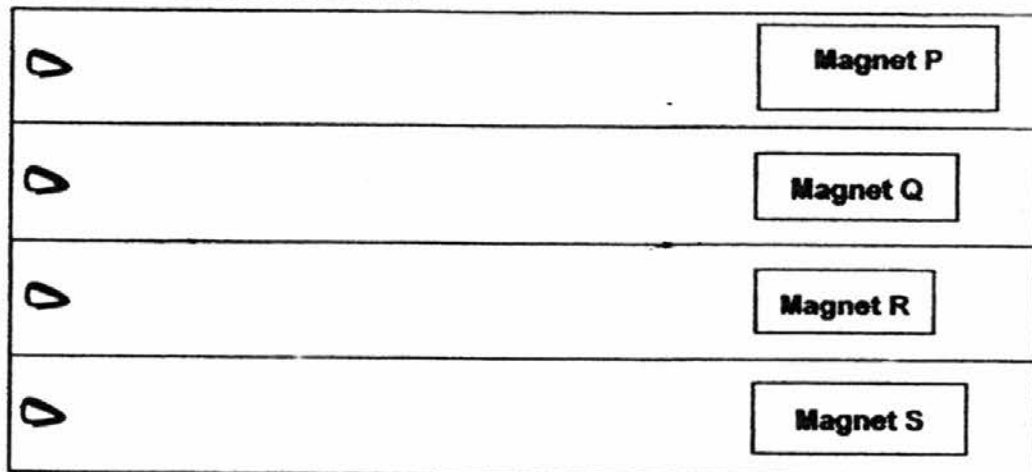

At the end of the experiment

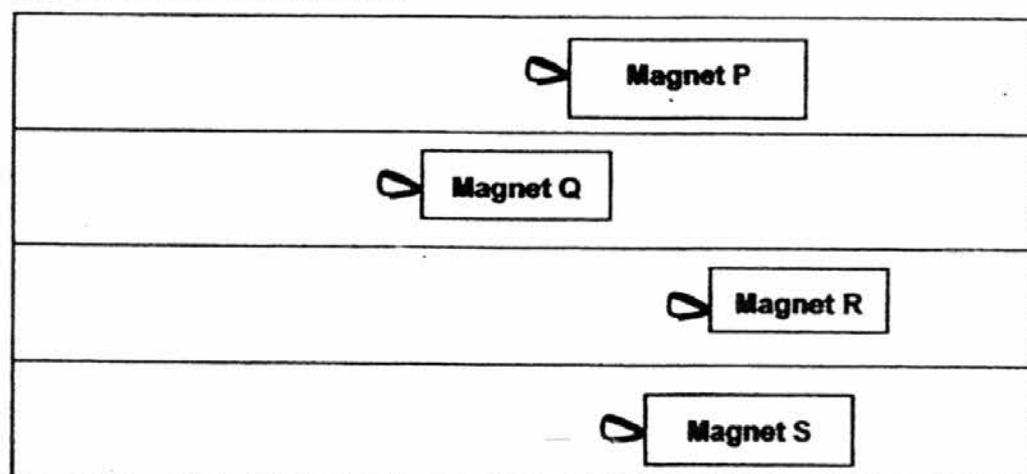

Based on Christine's experiment, which of the following two statements are correct?

- A Magnetic force can act at a distance.
- B The paper clip is made of a magnetic material.
- C The bigger the size of the magnet, the stronger is its magnetism.
- D The shorter distance the paper clip moves towards the magnet, the greater the magnetic strength of the magnet.

- (1) A and B
- (2) A and D
- (3) B and C
- (4) C and D

19. The diagram below shows the arrangement of four magnets when they are attracted to each other.

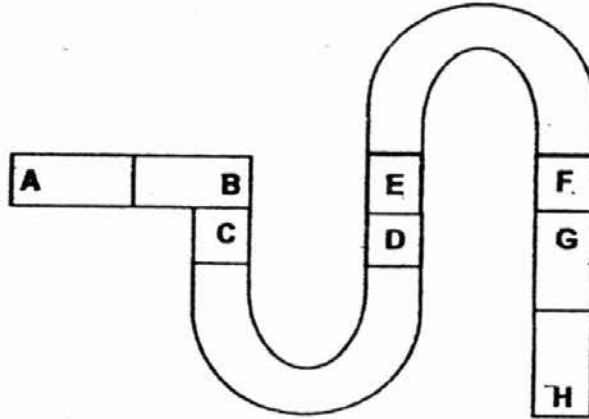

Which one of the following arrangements is possible?

<p>(1)</p>	<p>(2)</p>
<p>(3)</p>	<p>(4)</p>

20. Which of the following gives out both heat and light?

- A Star
- B Torchlight
- C Ceramic Plate
- D Computer Screen

- (1) A only
- (2) C and D only
- (3) B and C only
- (4) A, B and D only

21. Sally placed a cone in between two sheets, X and Y in a straight line. The sheets are made of different materials. A white screen was placed at the end of the line. When she shines a torchlight at Sheet X, a dark shadow can be seen on the screen as shown below.

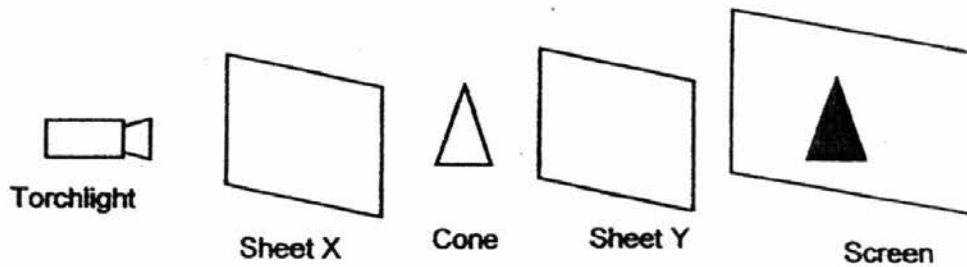

Which of the following shows the correct materials that sheets X and Y are made of?

	Sheet X	Sheet Y
(1)	Newspaper	Frosted Glass
(2)	Tracing Paper	Newspaper
(3)	Clear Plastic	Clear Glass
(4)	Clear Plastic	Frosted Glass

22. Study the diagram below.

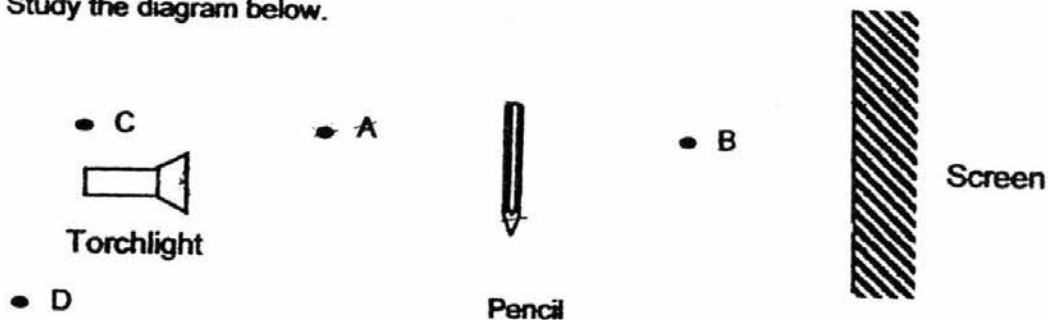

A shadow can be seen on the screen when the torchlight was switched on. At which point A, B, C or D did the path of light from the torchlight travel through?

- (1) A
 - (2) B
 - (3) C
 - (4) D
23. Four pieces of wax with equal mass were placed on top of four rods, A, B, C and D, made of different materials. The four rods were placed on an electrical heating plate at the same time, as shown in the diagram below.

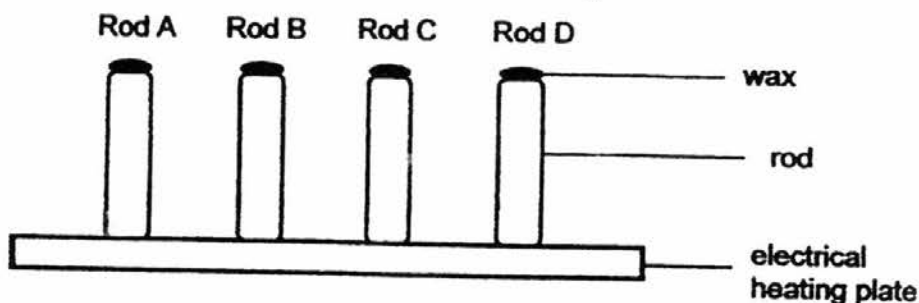

The table below shows the time taken for the wax on each rod to melt.

Rod	Time taken (min)
A	13
B	10
C	5
D	2

Which rod is the best conductor of heat?

- (1) A
- (2) B
- (3) C
- (4) D

24. Mr Tan hangs a spring made of steel on a tripod stand, as shown below. The original length of the spring is 2 cm long with a weight hung on it. Then, he removed the weight and heated up the spring with a candle for 10 minutes.

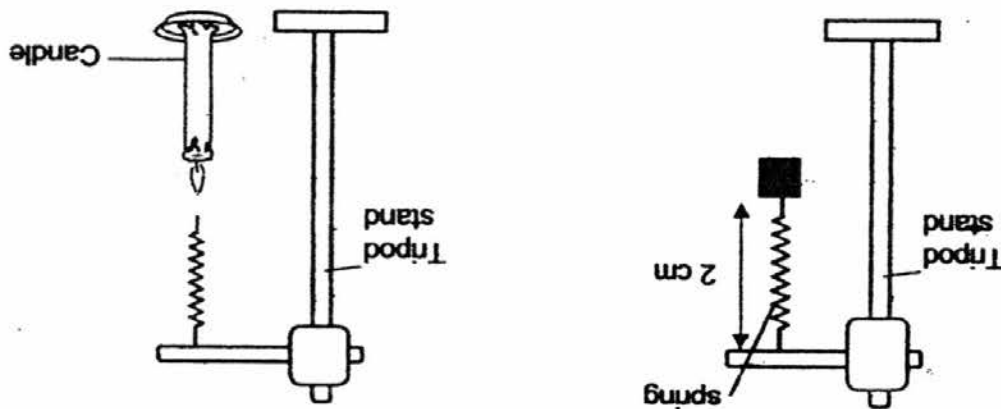

Mr Tan then hung the same weight on the spring that was heated. Which of the following is most likely how the spring will look like?

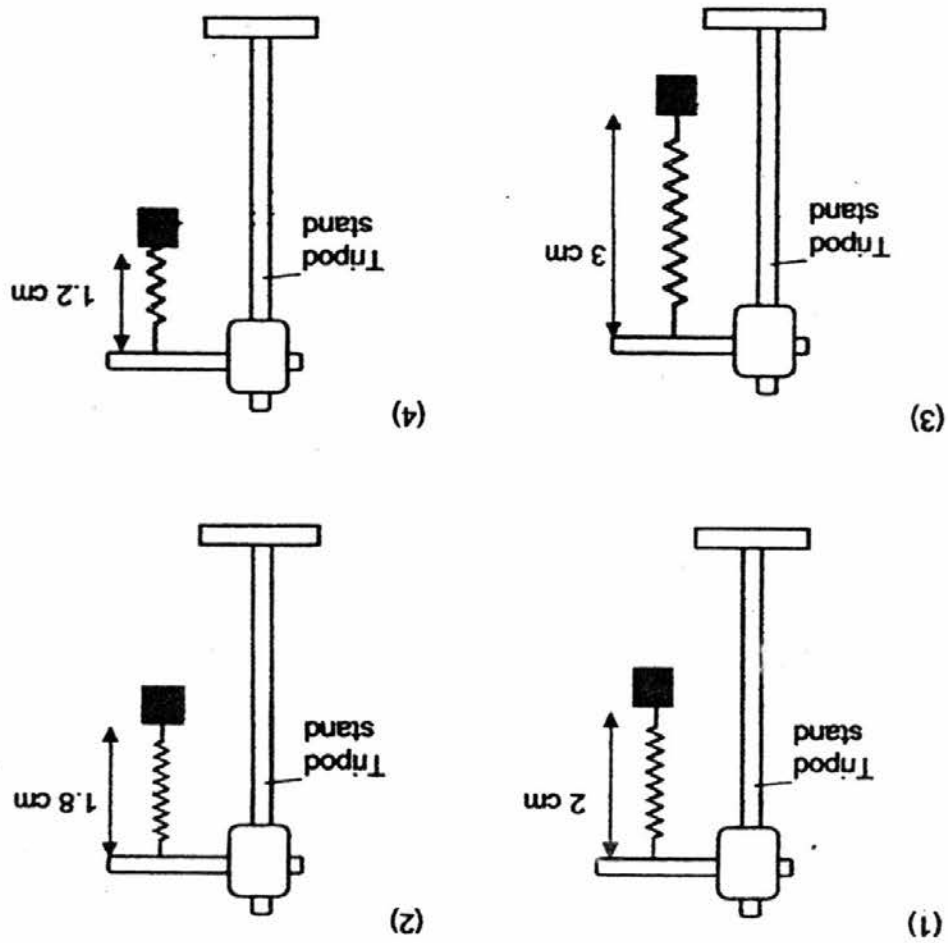

25. Suzy carried out an experiment to find out the effect of heat on four different coloured papers. The four different coloured papers were of the same mass and thickness. They were used to wrap all around four identical boxes and then left in an open field for six hours.

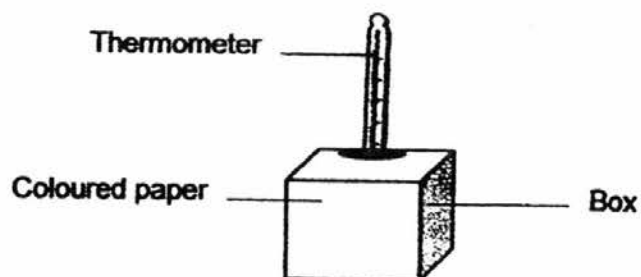

She recorded the temperature of each box every hour using the graph below.

Temperature ($^{\circ}\text{C}$)

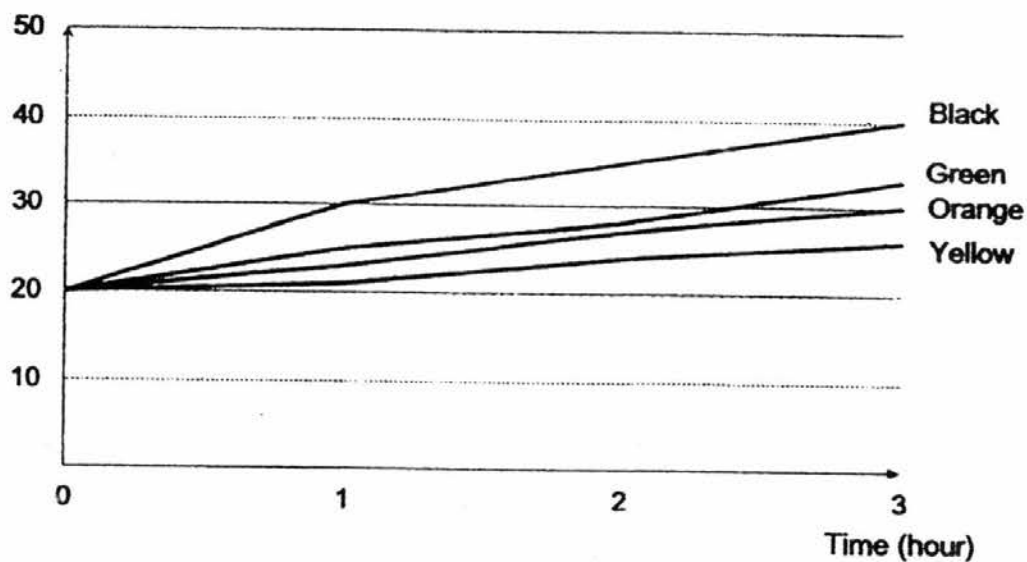

Suzy wants to wear a cotton T-shirt. Based on the graph above, which colour will be most suitable to be worn on a hot day if she wants to keep herself cool?

- (1) Black
- (2) Green
- (3) Yellow
- (4) Orange

Anglo-Chinese School (Junior)



SEMESTRAL ASSESSMENT 2 (2016)

PRIMARY 4

SCIENCE

BOOKLET B

Thursday

3 November 2016

1 hr 30 min

Name: _____ () Class: 4.() Parent's Signature: _____

INSTRUCTIONS TO PUPILS

- 1 Do not turn over the pages until you are told to do so.
- 2 Follow all instructions carefully.
- 3 There are 14 questions in this booklet.
- 4 Answer ALL questions.
- 5 The marks are given in the brackets [] at the end of each question or part question.

Booklet	Possible Marks	Marks Obtained
A	50	
B	40	
PBA	10	
Total	100	

Booklet B (40 marks)

For questions 26 to 39, write your answers in this booklet.

The number of marks available is shown in brackets [] at the end of each question or part question.

26. Alice placed two ring magnets, A and B, through a holder as shown below.

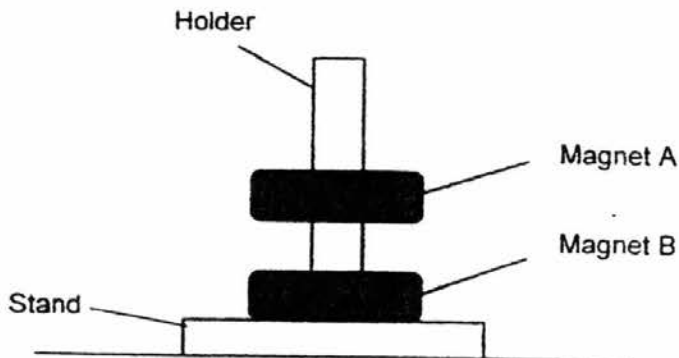

(a) The holder is made of wood and did not attract the magnets. [1]

Wood is a _____ material.

(b) Why is magnet A floating above magnet B? [1]

Magnet B is _____ magnet A.

(c) Two magnets are placed together as shown below.

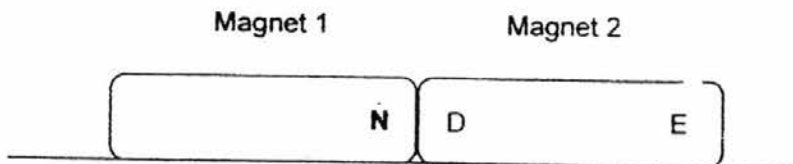

The north pole of magnet 1 is labelled N.

Name the poles labelled D and E on magnet 2. [2]

D: _____

E: _____

(Go on to the next page)

SCORE	4
-------	---

27. Look at the pictures. In the boxes below, tick (✓) the pictures which are sources of light. [2]

(a)

Mirror

Fire



Eyes

Lamp



(b) The diagram below shows a frying pan. Fill in the blanks below. [1]

Metal plate

Plastic handle

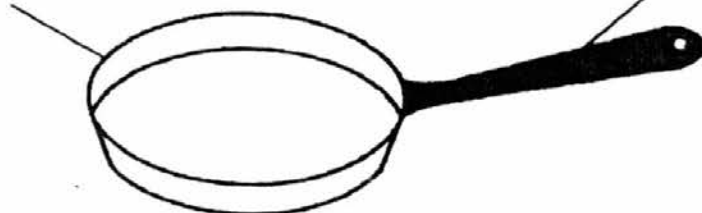

The handle is made of plastic because it is a _____ conductor of heat.

(Go on to the next page)

SCORE	
	3

28. The diagram shows a plant.

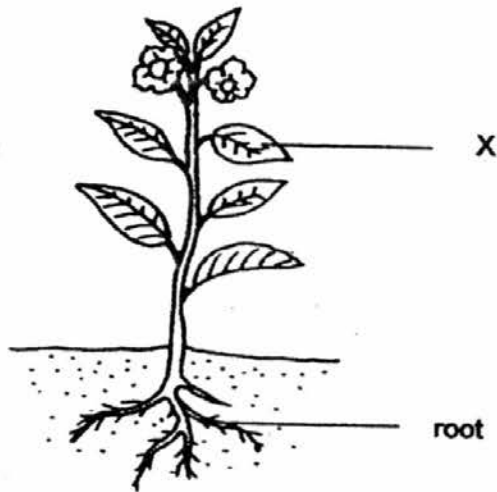

- (a) Name plant part X. [1]

X: _____

- (b) One substance that the roots of plants take in from the soil is [1]

(Go on to the next page)

SCORE	
	2

29. Classify the following animals according to the number of stages in their life cycle. [2]



Chicken



Mosquito



Beetle



Grasshopper

Three stages	Four stages

(Go on to the next page)

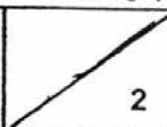
SCORE	 2
-------	---

30. The flowchart below shows the similarities and differences among materials E, F, G and H.

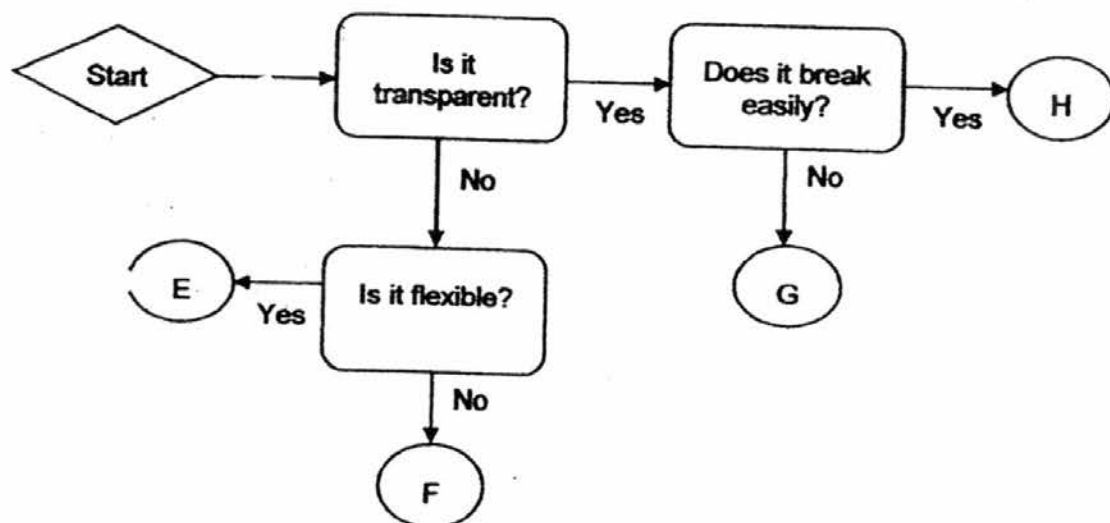

- (a) Based on the chart, state a similarity between Material E and F. [1]

- (b) Based on the chart, which material, E, F, G or H, is most likely to be glass? [1]

The picture below shows a water bottle.

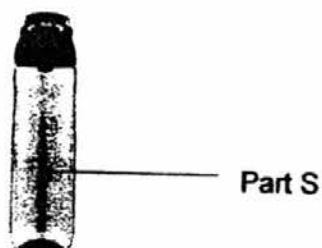

- (c) Mr Navin suggested using Material G instead of Material H to make part S. Give a reason why Material G is a better material for making part S of the water bottle. [1]

(Go on to the next page)

SCORE	
	3

31. (a) In which parts of the digestive system can digestive juices be found? [1]

- (b) What happens to food when it is completely digested? [1]

- (c) What would happen to the undigested food if the large intestine is not working well? [1]

32. Shane placed three green beans each into two beakers and placed them both near the window.

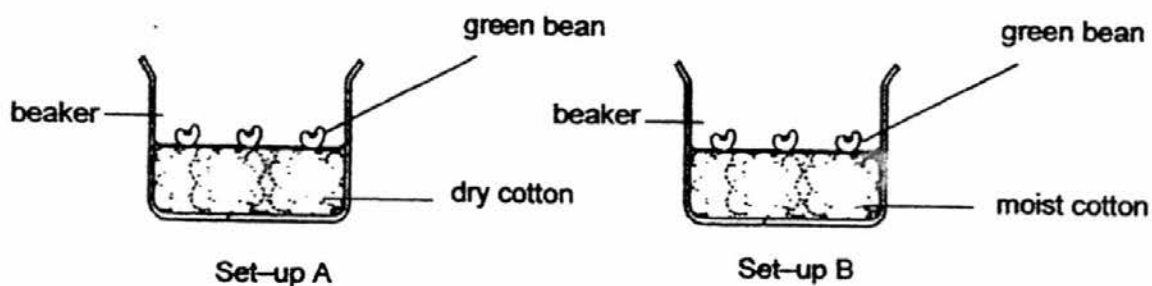

- (a) In which set-up will the seeds germinate? Explain why. [1]

- (b) During germination, which part of the young plant will grow from the seed first? [1]

(Go on to the next page)

SCORE	5
-------	---

33. Muthu hangs two identical balloons, A and B, on a lever balance. When both balloons are hung at an equal distance from the centre of the lever balance, the lever is balanced.

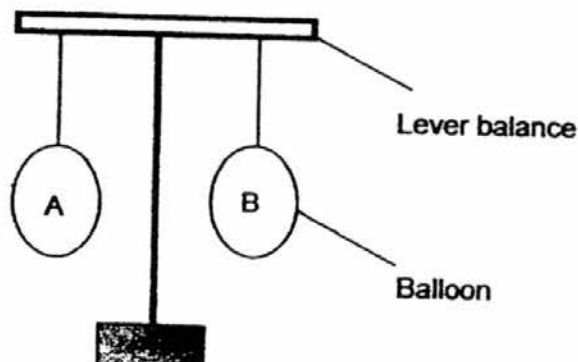

- (a) One of the properties of air is that air has mass. How can Muthu demonstrate this property by using only the set-up shown above? Explain your answer. [1]

- (b) Muthu's friend, John, gave him a container that has a capacity of 500 cm^3 . It has 200 cm^3 of water inside. Muthu connected a pump to the container and pushed the plunger of the pump twice. Each push allowed 50 cm^3 of air to enter the container.

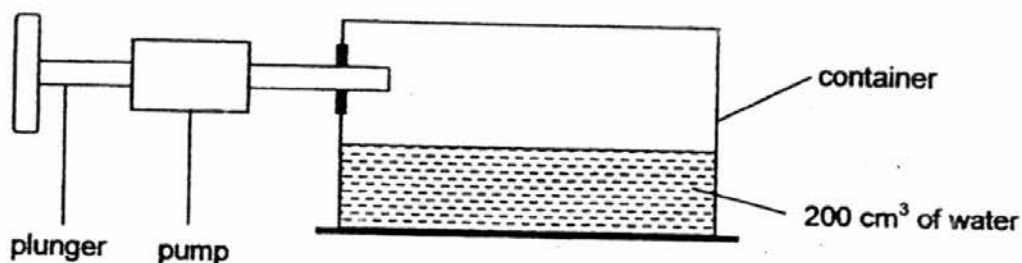

- What was the volume of air before and after air was pumped into the container? [1]

Before air was pumped into the container	After air was pumped into the container twice
i)	ii)

- (c) Explain your answer for (b)(ii). [1]

(Go on to the next page)

SCORE	
-------	--

- 34(a) (i) Betty poured a jug of water into Vessel J as shown in the diagram below. Draw the water level for tubes A, B, C, D and E. [1]

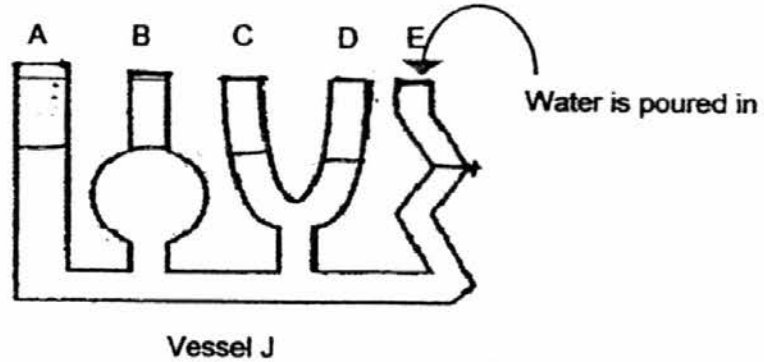

- (ii) Betty poured out all water from Vessel J and sealed tube A with a stopper as shown in the diagram. She poured water into the vessel until it overflowed at tube E. Draw the water level for tubes A, B, C, D and E.

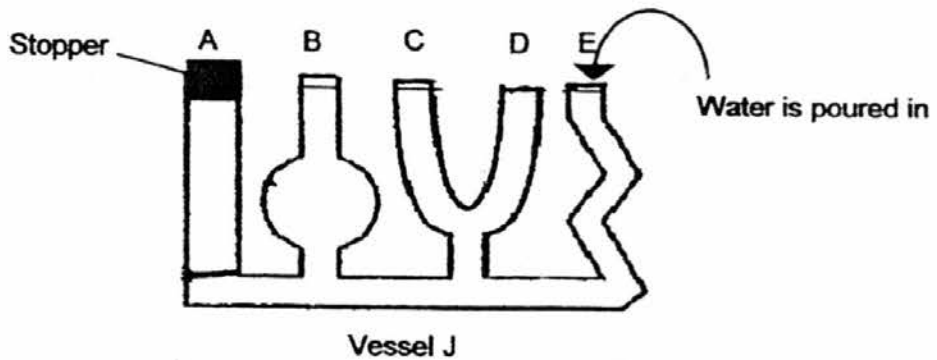

- (b) Explain your answer for (a)(ii).

[1]

- (c) What does this experiment show about the property of liquid?

[1]

(Go on to the next page)

SCORE	
	3

35. Jack carried out an experiment to find out if the number of times an iron nail is stroked with a magnet affects its magnetic strength. He stroked the iron nail with the north pole of a magnet in the same direction as shown below.

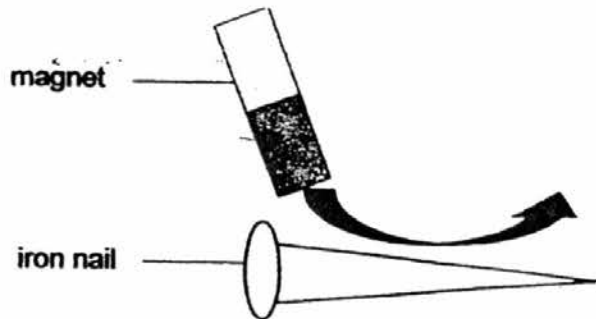

After stroking, he placed the iron nail 5cm away from a tray of paper clips. He recorded his results in the table below.

Number of Strokes	Number of paper clips attracted to the nail
10	2
20	4
30	6
40	8
50	10

- (a) Based on his experiment, what is the relationship between the number of strokes and the magnetic strength of the iron nail?

[1]

- (b) Use the results of his experiment to plot the graph.

[1]

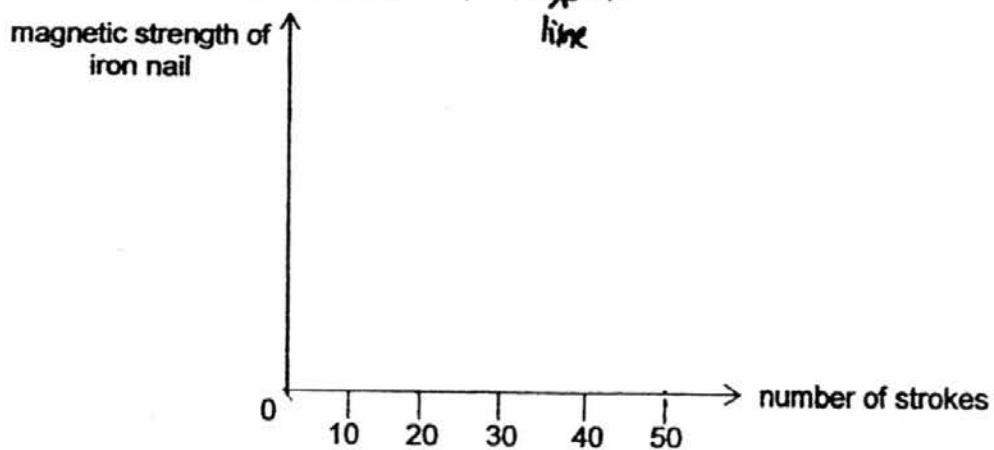

(Go on to the next page)

SCORE	2
-------	---

Jack used the same magnet to stroke a copper nail 10 times. Then, he placed the copper nail 5cm away from the same tray of paper clips.

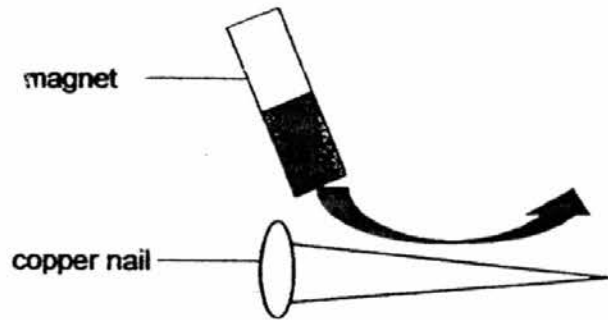

- (c) Predict the number of paper clips that will be attracted to the copper nail. Explain your answer. [1]

(Go on to the next page)

SCORE	1
-------	---

36. Andy's mother gave him a long bar magnet. He wrote the letters, P, Q, R, S and T on different parts of the bar magnet as shown in the diagram below.

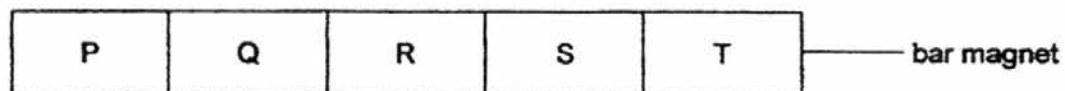

Next, he lowered the bar magnet into a tray of metal pins and then counted the number of metal pins attracted to the different parts of the bar magnet. He then plotted his results in the bar graph below.

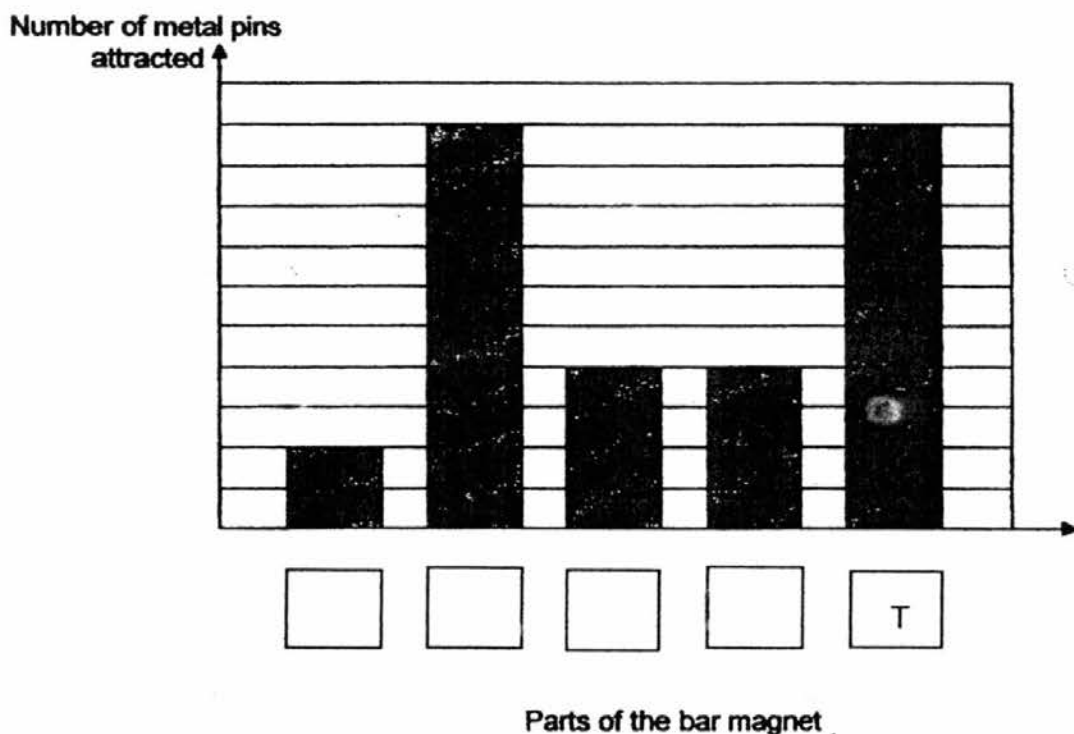

- (a) In the graph above, name the parts, P, Q, R and S of the bar magnet by filling in the boxes. [2]
- (b) What can Andy conclude about the magnetic strength at different parts of the bar magnet? [1]

(Go on to the next page)

SCORE	3
-------	---

37. Sharifah sets up the experiment below to measure the amount of light that passes through a container of liquid. She poured 50cm^3 of apple juice, 50cm^3 of tap water and 50cm^3 of coffee into 3 containers. A lighted torch is placed at equal distance from the top of each container.

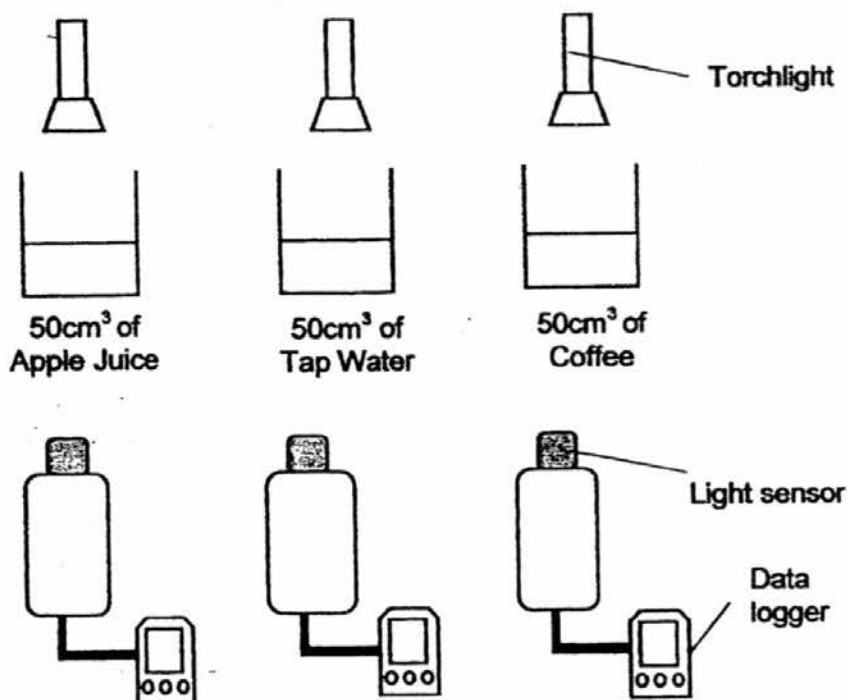

She used a light sensor connected to a data logger to measure the amount of light that passes through each container of liquid and recorded them in the table below. Her brother labelled the containers in random order as X, Y and Z.

Container	X	Y	Z
Amount of light (Lux)	0	115	1138

- (a) Based on the above results, write down the type of liquid found in each container. [2]

X - _____

Z - _____

- (b) Explain why no light is able to pass through Container X. [1]

(Go on to the next page)

SCORE	3
-------	---

38. Susan set up the experiment below to find out how the distance between the screen and the rubber ring affects the size of the shadow formed on the screen.

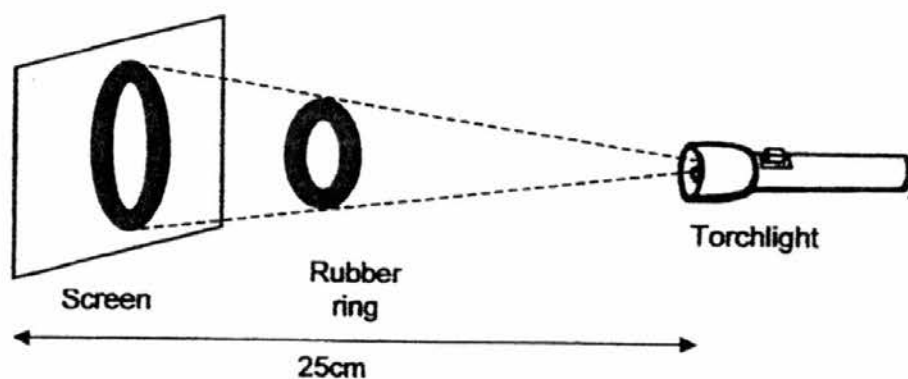

She recorded the results of her experiment in the table below.

Distance between screen and torchlight (cm)	Distance between screen and rubber ring (cm)	Height of shadow formed on the screen (cm)
25	12	16
25	7	13
25	4	10

- (a) Based on the results of the experiment, what can Susan conclude about the relationship between the height of the shadow formed and the distance between the screen and rubber ring? [1]

- (b) State two changes Susan can make to the set-up to form a bigger shadow without moving the rubber ring. [2]

(Go on to the next page)

SCORE	3
-------	---

- (c) Susan wanted to perform a 'magic trick' for her brother. She told him that there will be no shadow on the screen when she shines a torchlight at object X.

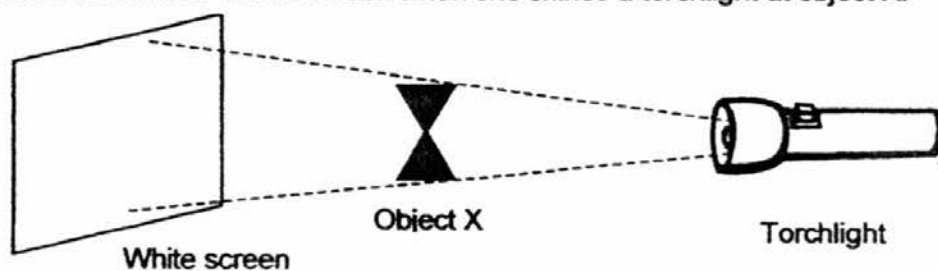

Suggest a suitable material that object X should be made of so that Susan can achieve this 'magic trick'.

[1]

39. Joe wanted to find out which material is most suitable to keep his coffee warm for the longest period of time. He placed three identical bottles A, B and C made of different materials on the dining table. He put identical thermometers into each bottle to measure the temperature of the 200cm³ of coffee inside it.

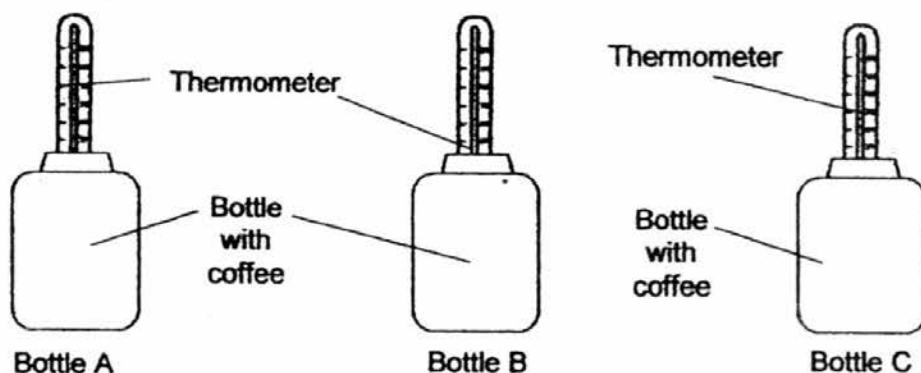

Joe recorded the temperature of the coffee in each bottle every 5 minutes and recorded in the table below.

Time (min)	Temperature of coffee in Bottle A (°C)	Temperature of coffee in Bottle B (°C)	Temperature of coffee in Bottle C (°C)
0	38	38	38
5	38	35	31
10	37	32	26
15	37	30	22

- (a) Identify the changed variable and one other constant variable in the experiment. [1]

Changed variable - _____

Constant variable - _____

- (b) Which bottle is most suitable to keep coffee warm for the longest period of time? [1]
Explain your answer.

End of Booklet

SCORE	
-------	--

YEAR : 2016
 LEVEL : PRIMARY 4
 SCHOOL : ANGLO-CHINESE (JUNIOR)
 SUBJECT : SCIENCE
 TERM : SA2

Booklet A

Q1	2	Q6	3	Q11	3	Q16	3	Q21	3
Q2	3	Q7	4	Q12	4	Q17	3	Q22	1
Q3	1	Q8	1	Q13	3	Q18	1	Q23	4
Q4	2	Q9	2	Q14	3	Q19	2	Q24	3
Q5	3	Q10	2	Q15	3	Q20	4	Q25	3

Booklet B

Q26 (a) Wood is a non-magnetic material.

(b) Magnet B is repelling magnet A.

(c) D : South pole

E : North pole

Q27 (a) ✓ Fire & ✓ Lamp

(b) The handle is made of plastic because it is a poor conductor of heat.

Q28 (a) X : Leaf

(b) Water

Q29

Three stages	Four stages
Chicken Grasshopper	Mosquito Beetle

- Q30
- (a) They are not transparent.
 - (b) Material H.
 - (c) Material G does not break easily but material H does break easily.

- Q31
- (a) Mouth, stomach and small intestine.
 - (b) The food would be absorbed into the bloodstream.
 - (c) Water in the undigested food will not be absorbed and the undigested food will be watery.

- Q32
- (a) Set-up B. It has warmth, air and water so it can germinate.
 - (b) Roots

- Q33
- (a) He can deflate one balloon. If he deflate one balloon, the balloon at the other end would go down, this shows that air has mass.

(b)

Before air was pumped into the container	After air was pumped into the container twice
i) 300 cm^3	ii) 300 cm^3

- (c) Air can be compressed.

Q34

(a) (i)

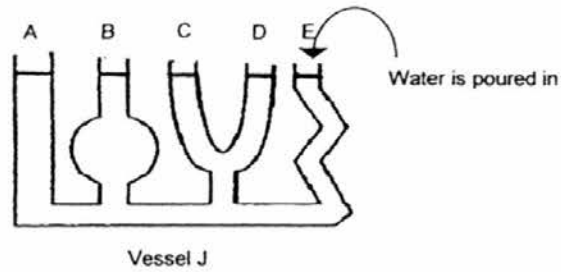

(ii)

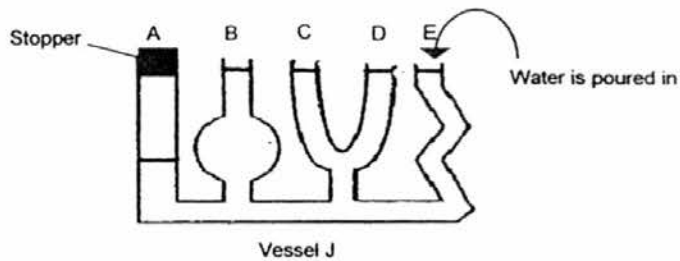

- (b) Air occupies space. Air cannot escape in tube A due to the stopper.
- (c) Liquid occupy space.

Q35

- (a) The more time the iron nail is stroked, the greater the magnetic strength.
- (b)

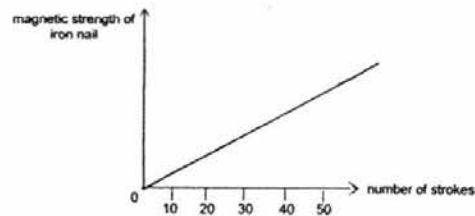

- (c) 0. Copper is a non-magnetic material and can't be magnetised.

Q36

- (a)

R	P	Q	S	T
---	---	---	---	---

- (b) The magnetic strength is strongest at the magnet's poles.

- Q37 (a) X – Coffee
Z – Tap water
- (b) Coffee is black in colour and does not allow light to pass through it.
- Q38 (a) The closer the screen is to the rubber ring, the shorter the shadow.
- (b) 1. Move the screen away from the ring.
2. Move the torch closer to the ring.
- (c) Clear glass.
- Q39 (a) Changed variable – Material of bottle.
Constant variable – Location of experiment.
- (b) It has the least change in temperature.

End



AI TONG SCHOOL

2016 END-OF-YEAR EXAMINATION PRIMARY FOUR SCIENCE

DURATION: 1 hour 45 minutes

DATE: 27 October 2016

INSTRUCTIONS

Do not open the booklet until you are told to do so.
Follow all instructions.

Answer all questions.

Name : _____ ()

Class : Primary 4 _____

Parent's Signature : _____

Date : _____

Section A	56
Section B	44
Total	100
Project Work	20
Final Total	120

Section A (28 x 2 marks)

For each question from 1 to 28, four options are given. One of them is the correct answer. Make your choice and shade the correct oval (1, 2, 3 or 4) on the Optical Answer Sheet.

1. The pictures below show an

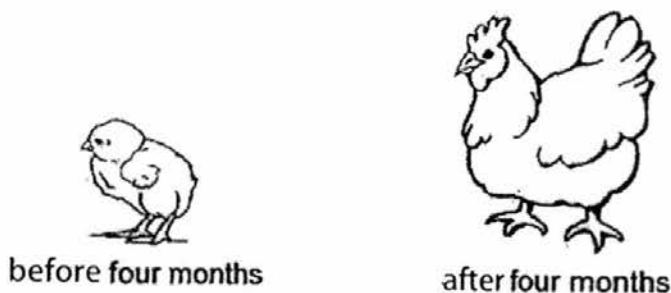

This shows that the animal is a living thing because it can _____.

- (1) grow
 - (2) breathe
 - (3) respond
 - (4) reproduce
2. The diagram below shows the life cycle of an animal.

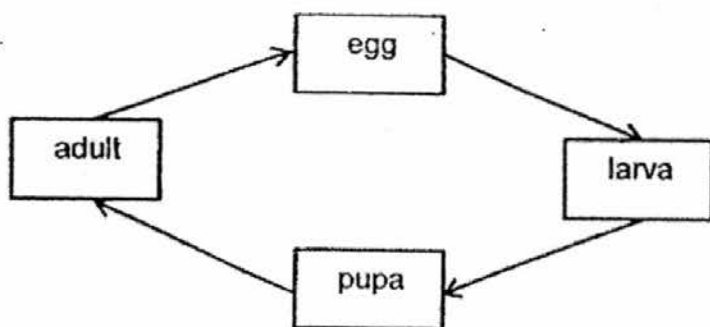

Which animal is likely to have the life cycle as shown above?

- (1) frog
- (2) butterfly
- (3) cockroach
- (4) grasshopper

3. Study the diagram below.

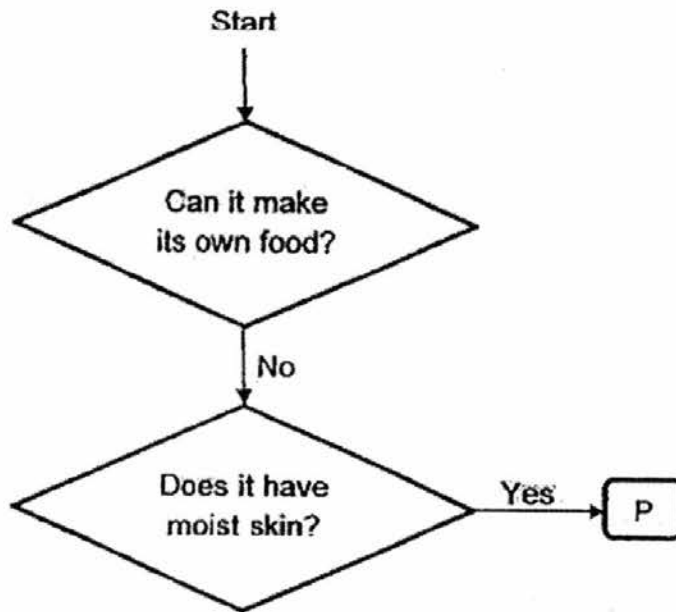

What could P be?

- (1) plant
- (2) reptile
- (3) mammal
- (4) amphibian

4. In which part of the digestive system is water absorbed from undigested food?

- (1) gullet
- (2) stomach
- (3) small intestine
- (4) large intestine

5. The diagram below shows a plant.

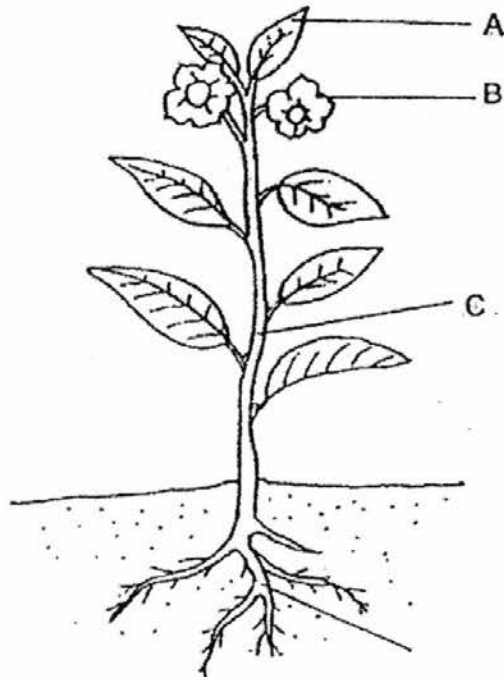

Which part ,A, B, C or D, holds the plant upright?

- (1) A
- (2) B
- (3) C
- (4) D

6. Matter is anything that has mass and occupies space.

Which one of the following is NOT matter?

- (1) air
- (2) soil
- (3) light
- (4) water

7. Tiffany put an iron nail into a container of water. At which position, A, B, C or D would the iron nail most likely be found?

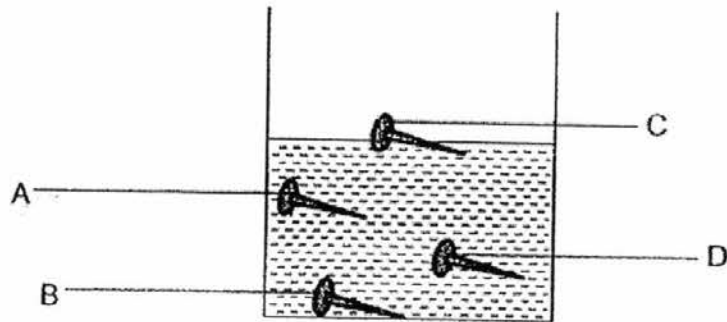

- (1) A
- (2) B
- (3) C
- (4) D

8. The set-up below shows light shining on a wooden cube.

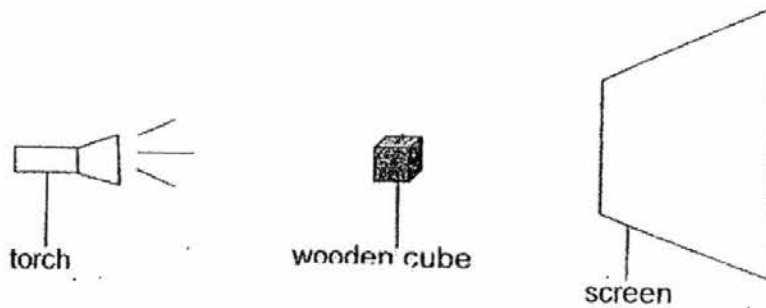

Which of the following would likely be seen on the screen?

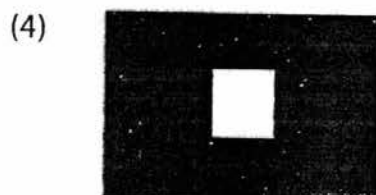
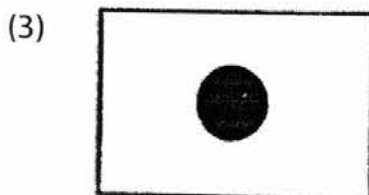
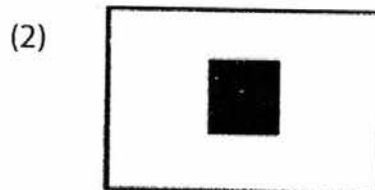
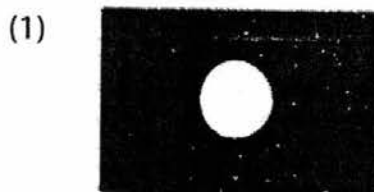

9. James wants to find out the temperature of the water in a beaker.

Which one of the following diagrams show the correct position of the thermometer when taking the temperature reading?

(1)

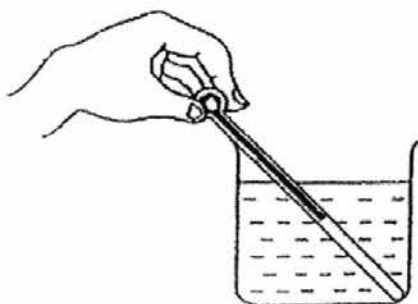

(2)

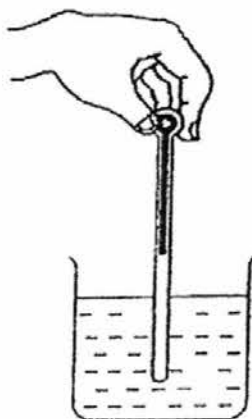

(3)

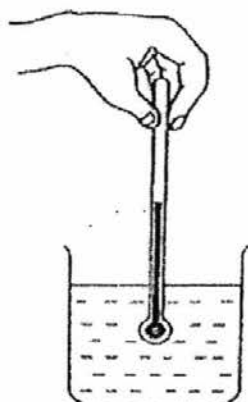

(4)

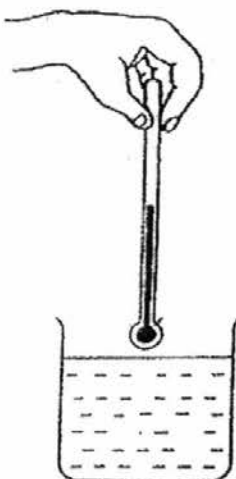

10. In which one of the following will the two magnets push each other away?

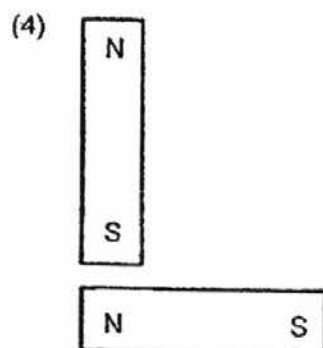
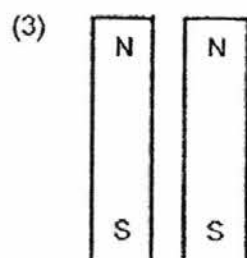
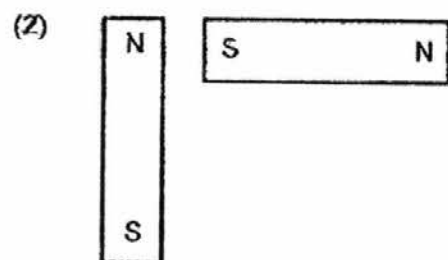
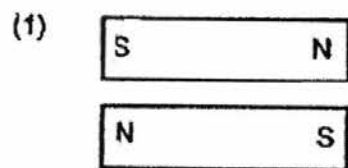

11. Diagram A below shows a plant with widespread roots. Sam decided to cut the roots of the plant as shown in diagram B.



Diagram A



Diagram B

Which of the following would happen to this plant now that its roots are cut?

- (1) It would absorb more water.
 - (2) It would absorb less sunlight.
 - (3) It would hold the plant more upright.
 - (4) It would hold the plant less firmly to the ground.
12. Sheryl wanted to find out if the amount of digestive juice affects how fast a piece of bread is digested.

Setup	Amount of digestive juice (ml)	Amount of bread (g)	Duration of experiment (mins)	Location of experiment
W	10	5	15	Field
X	10	5	20	Classroom
Y	20	5	15	Field
Z	20	10	20	Classroom

Which two set-ups above should she use to conduct a fair test for her experiment?

- (1) W and X
- (2) W and Y
- (3) X and Y
- (4) Y and Z

- 13 Sally carried out an experiment for twenty minutes using the two set-ups P and Q below

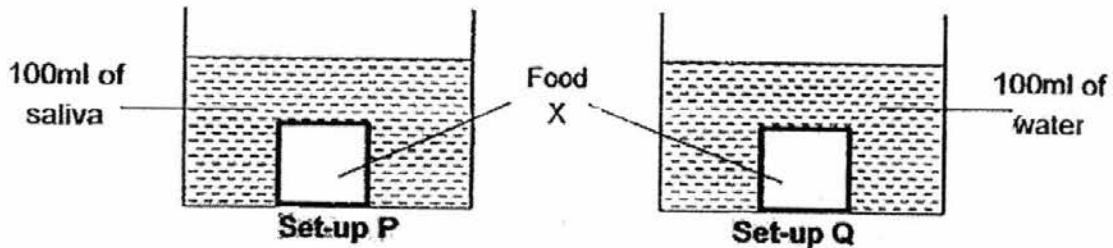

Food X has starch and saliva can digest food X completely in twenty minutes. Iodine solution, which was added to both set-ups at the start of the experiment, turns dark blue if starch is present. It remains yellowish-brown if starch is digested. Which of the following shows the correct colour of iodine solution before and after the experiment?

	colour of iodine solution before the experiment		colour of iodine solution after the experiment	
	Set-up P	Set-up Q	Set-up P	Set-up Q
(1)	dark blue	dark blue	dark blue	yellowish-brown
(2)	yellowish-brown	yellowish-brown	yellowish-brown	dark blue
(3)	dark blue	dark blue	yellowish-brown	dark blue
(4)	yellowish-brown	dark blue	dark blue	yellowish-brown

14. Jasmine recorded the mass of four objects, which were of the same size but made of different materials, A, B, C and D. She then put them in a container of water. After 20 minutes, she removed the objects from the water. The mass of the objects were measured and recorded again in the table below.

Object made	(g)	
A	9	11
B	13	18
C	15	15
D	10	27

Which of the above materials would be most suitable to make part X of a helmet?

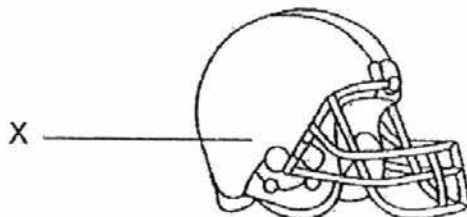

- (1) A
- (2) B
- (3) C
- (4) D

15. In an amusement park, people drive bumper cars and try to bump one another at



What properties must the material used to make part W have

- (1) flexible and smooth
 - (2) flexible and strong
 - (3) stiff and smooth
 - (4) stiff and strong
16. Two objects, T and U, are placed on a balance as shown below.



Which of the following statements are correct based on the diagram above?

- A U has more mass than T.
 - B T has the same mass as U.
 - C T has a larger volume than U.
 - D T and U have the same volume.
- (1) A only
 - (2) B only
 - (3) A and C only
 - (4) B and D only

17. The diagram below shows a sealed container with a volume of 300 cm^3 which was completely filled with air. A syringe was then used to remove 75 cm^3 of from

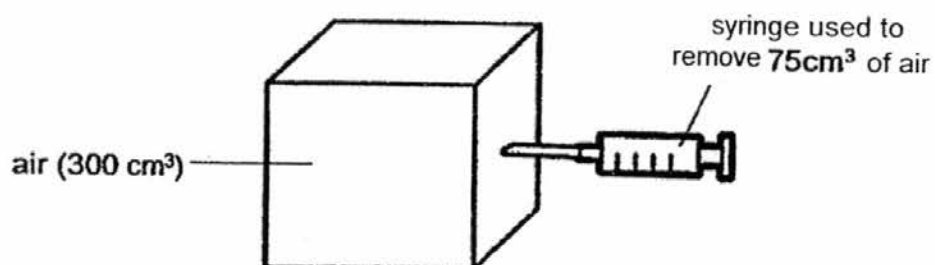

What is the final volume of air in the container if the container did not change its shape?

- (1) 75 cm^3
 - (2) 225 cm^3
 - (3) 300 cm^3
 - (4) 375 cm^3
18. The diagram below shows equal amounts of three substances X, Y and Z in three similar containers.

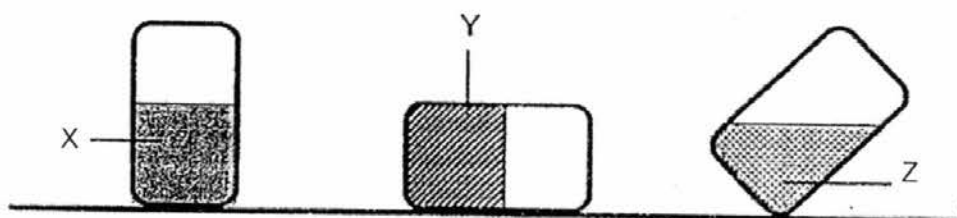

Based on the diagram, which of the statements is **definitely** correct?

- (1) Substance Y is a solid.
- (2) Substances X and Z are liquid.
- (3) Substance Z does not have a definite volume.
- (4) Substances X and Y take the shape of their containers.

19. Study the flowchart below.

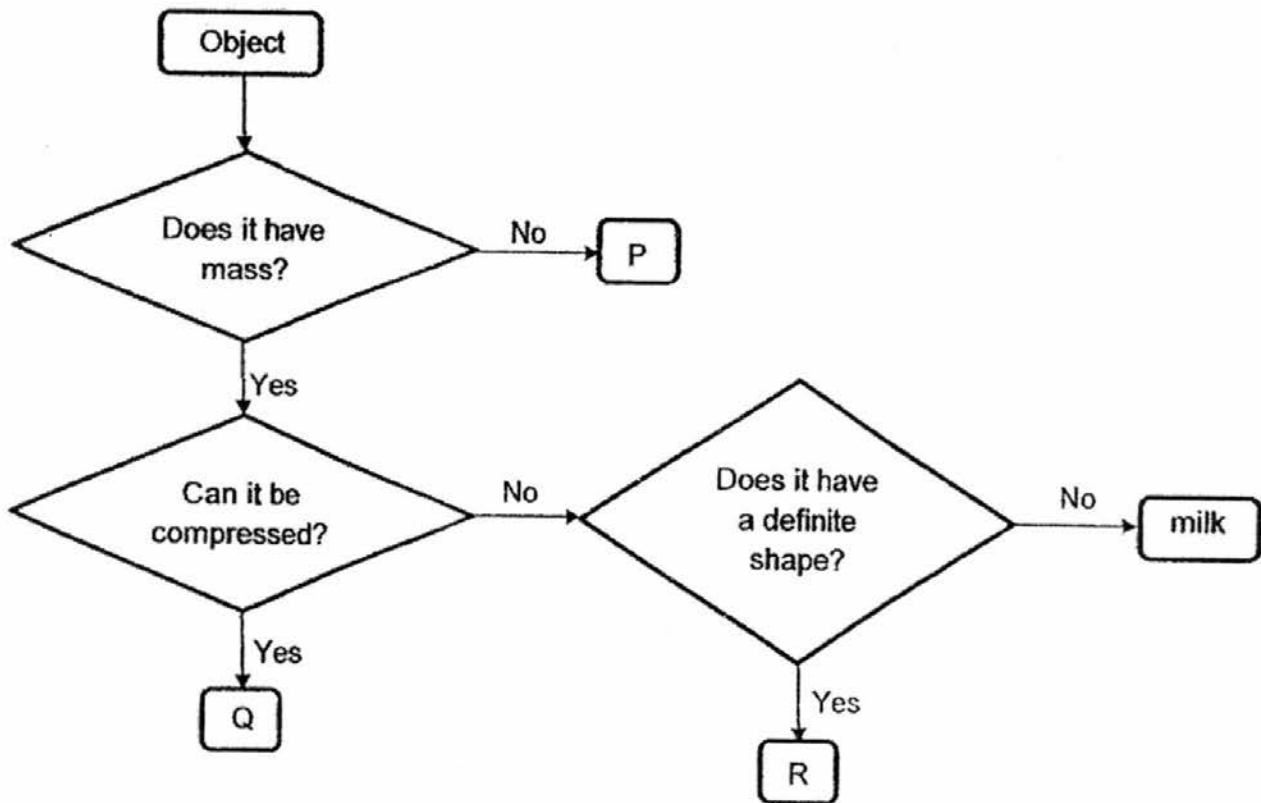

Which of the following correctly represent P, Q and R?

	P	Q	R
(1)	wind	shadow	book
(2)	heat	wind	oil
(3)	oil	heat	air
(4)	shadow	air	book

20. Kenneth found three objects and he wanted to test if they were magnets. He placed a bar magnet next to each end of the objects and recorded his observations.

object	D	E	F
Observations	No reaction was observed	One end was attracted to the bar magnet and the other end was repelled by the bar magnet	Both ends were attracted to the bar magnet

Which of the following correctly shows what objects D, E and F could be?

	D	E	F
(1)	wooden ruler	magnet	steel spoon
(2)	steel spoon	magnet	plastic spoon
(3)	plastic spoon	iron rod	magnet
(4)	magnet	wooden ruler	iron rod

21. Ethan set up an experiment as shown below to test how some variables affect the strength of an electromagnet.

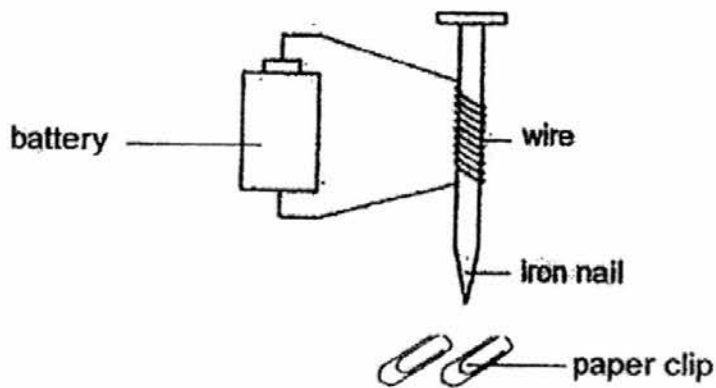

Which of the following graphs correctly shows a possible result of his experiment?

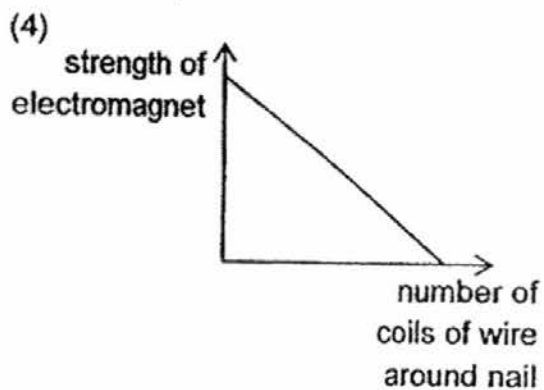
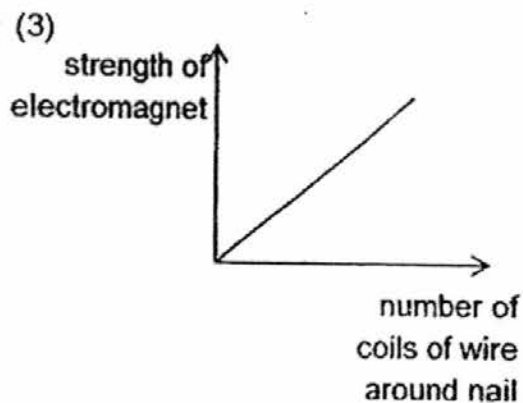
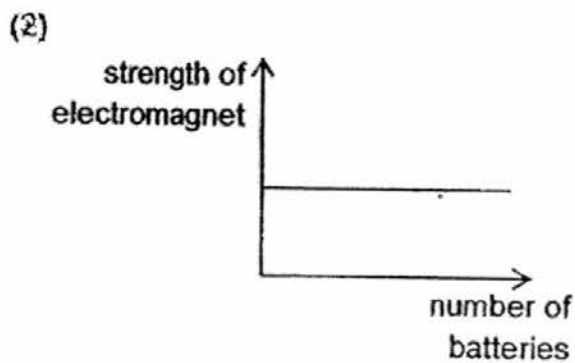
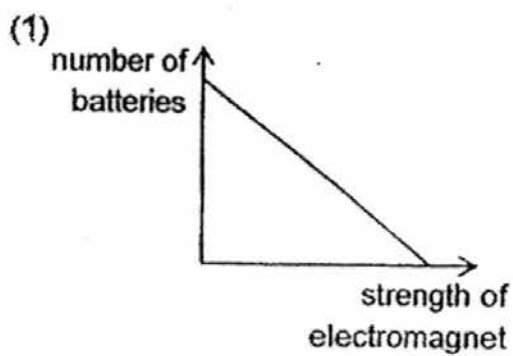

22. Nadia carried out an experiment using some paper clips and a magnet.

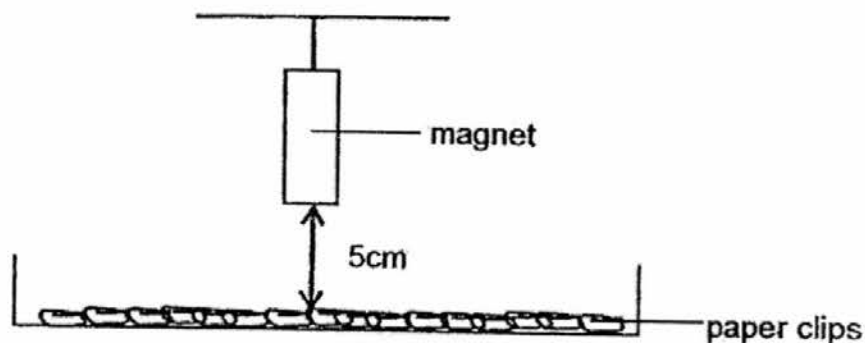

The magnet was hung 5cm above the paper clips. Nadia then counted the number of paper clips that were attracted to it.

She repeated the experiment with the magnet at different distances from the paper clips.

What do you think was the aim of Nadia's experiment?

- (1) To find out if the number of magnets affects the magnetic strength of the magnet
- (2) To find out if the number of paper clips affects the magnetic strength of the magnet
- (3) To find out if the type of magnet affects the number of paper clips attracted
- (4) To find out if the distance between the magnet and paper clips affects the number of paper clips attracted

23. Sara bought a glass of hot coffee. As it was too hot to drink, she put some ice cubes in it and used a straw to stir it.

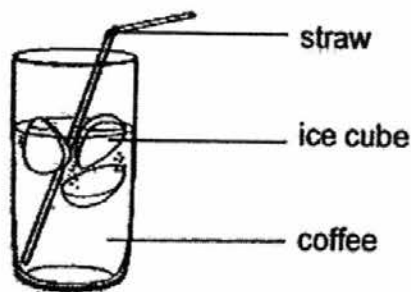

Which of the following correctly shows what happens to the coffee, straw and ice cubes?

	coffee	straw	ice cubes
(1)	loses heat	gains heat	gains heat
(2)	gains heat	gains heat	loses heat
(3)	gains heat	loses heat	gains heat
(4)	loses heat	gains heat	loses heat

24. Ming Hua has a glass cup with thick walls.

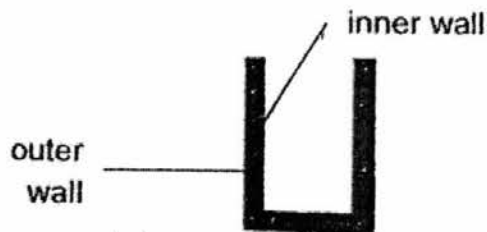

He filled the cup with boiling water and noticed that the cup cracked.

Which of the following explains why the cup cracked?

- (1) The water expanded faster than the glass cup.
- (2) The glass cup contracted faster than the water.
- (3) The outer wall of the glass cup contracted faster than the inner wall of the glass cup.
- (4) The inner wall of the glass cup expanded faster than the outer wall of the glass cup.

25. Raegan wanted to compare the speed at which heat passes through four different materials P,Q,R and S. He set up the apparatus as shown below.

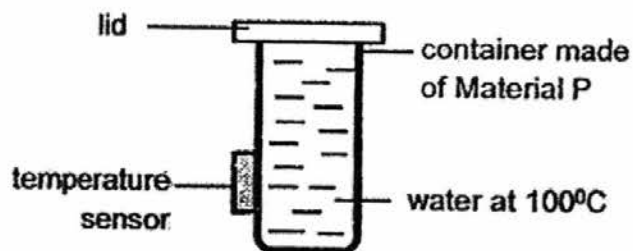

A temperature sensor was placed on the outer surface of a container made of Material P, which was originally at room temperature. Raegan poured water at 100 C into the container.

Thirty seconds later, he recorded the temperature that was captured by the temperature sensor.

He then repeated the experiment with similar-sized containers made of materials Q, R and S, which were all originally also at room temperature. The table below shows the result obtained.

Material	Temperature (°C)
P	78
Q	55
R	30
S	92

Based on the results, which of the following statements is correct?

- (1) Material R is the best conductor of heat.
- (2) Material S is the poorest conductor of heat.
- (3) Material Q is a better conductor of heat than Material S.
- (4) Material P is a better conductor of heat than Material Q.

26. The diagram below shows a bent tube.

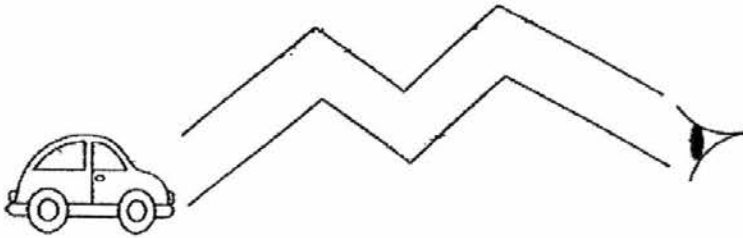

What is the smallest number of mirrors that must be placed in the tube for Jane to see the toy car?

- (1) 1
- (2) 2
- (3) 3
- (4) 4

27. Ling Li was walking along a street near a street lamp one night.

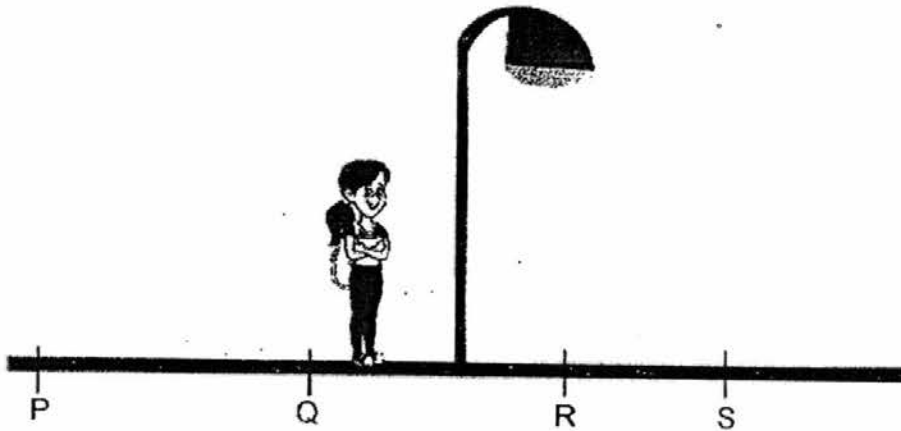

At which point would her shadow be the longest?

- (1) P
- (2) Q
- (3) R
- (4) S

28. Mrs Tan used four materials, A, B, C, and D, to build four walls in a playroom for her children.

Material	Does not allow light to pass through	Allows some light to pass through	Allows all light to pass through
A	√		
B			√
C	√		
D		√	

She then asked her five children to stand behind the walls as shown in the diagram below.

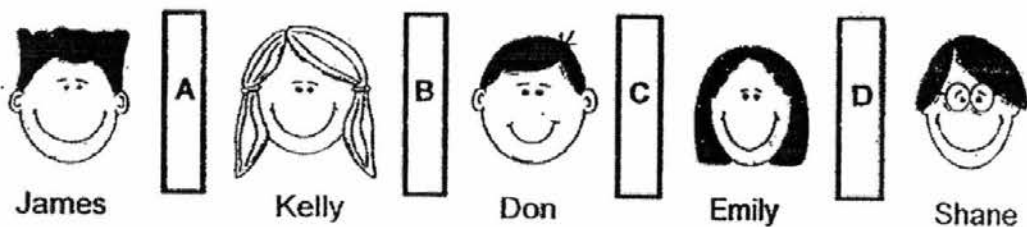

Which of the following statements is true?

- (1) Shane cannot see Emily.
- (2) Don can see Kelly and Emily.
- (3) Emily can see Don and Shane.
- (4) Kelly can see Don but not James.

END OF BOOKLET A

Name: _____ (

End-of-Year 2016

Class P4 ()

Marks: _____/44

Section B: 44 marks

Read the questions carefully and write down your answers in the spaces provided.

29. The diagram below shows the young and adult of some organisms. Draw lines to match the young with the correct adult. [3]

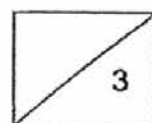
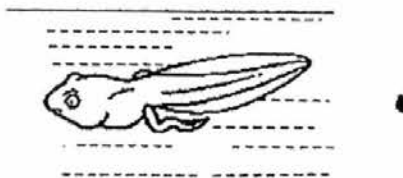
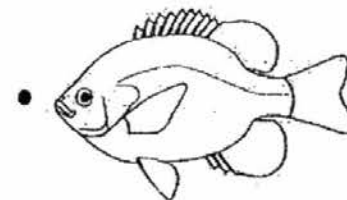
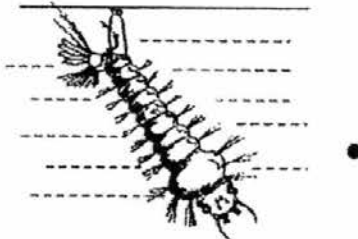

30. The diagram below shows two plants.

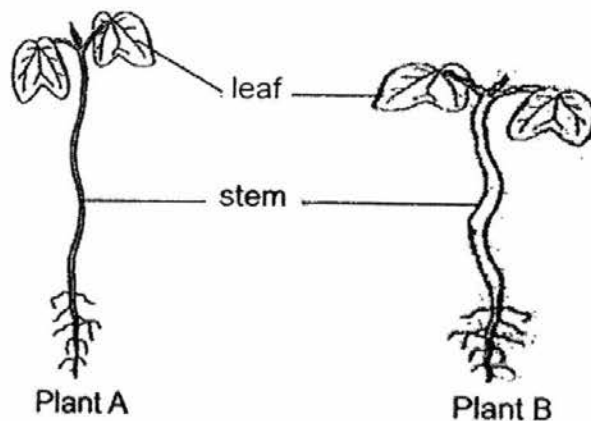

(a) What is one difference between the stem of plant A and the stem of Plant B? [1]

The stem of Plant A is _____ than the stem of Plant B.

(b) The leaves help both plants make _____ in the light. [1]

31. The diagram below shows an iron.

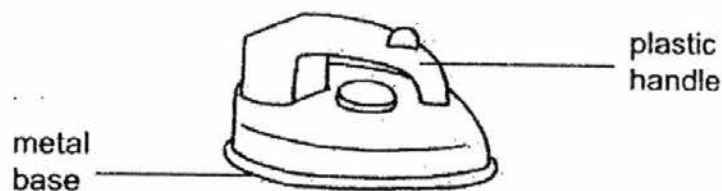

(a) The handle is made of plastic because plastic is a _____ conductor of heat. [1]

(b) The base is made of metal because metal is a _____ conductor of heat. [1]

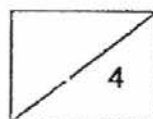

32. Susan placed a magnet near an iron rod as shown below.



The

(a) The magnet exerts a _____ on the iron rod. [1]

(b) Choose the correct word from the box to answer the question below. [1]

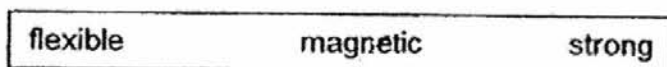

Susan's observation shows that the iron is a _____ material.

Susan then stroked two similar iron rods X and Y with the same magnet as shown in the figure below.

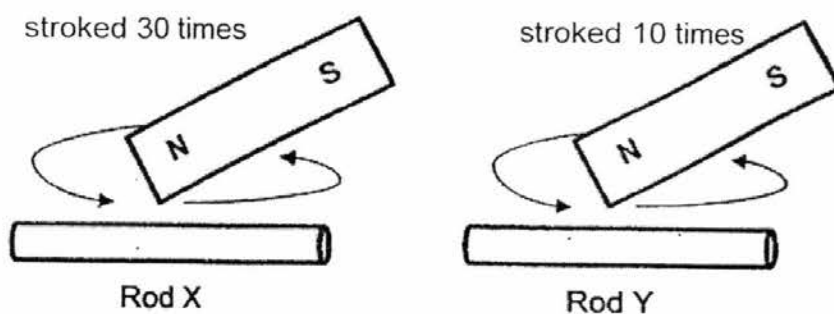

Both rods became magnets and were used to attract similar pins.

(c) Circle the correct answer below. [1]

Rod X attracted ('less pins than' / 'the same number of pins as' / 'more pins than') Rod Y.

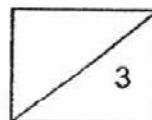

33. Megan planted a seed and measured the mass of the seed leaf and height of the plant over 9 days. She recorded her findings in the table below.

Day	Mass of seed leaf (g)	Height of plant (cm)
1	2.8	1.5
3	1.9	3.0
5	1.0	3.9
7	0.7	5.2
9	0.4	7.0

- (a) Why did the mass of the seed leaf decrease over time?

[1]

- (b) Based on the findings, draw a graph to show the relationship between the number of days and the mass of seed leaf.

[2]

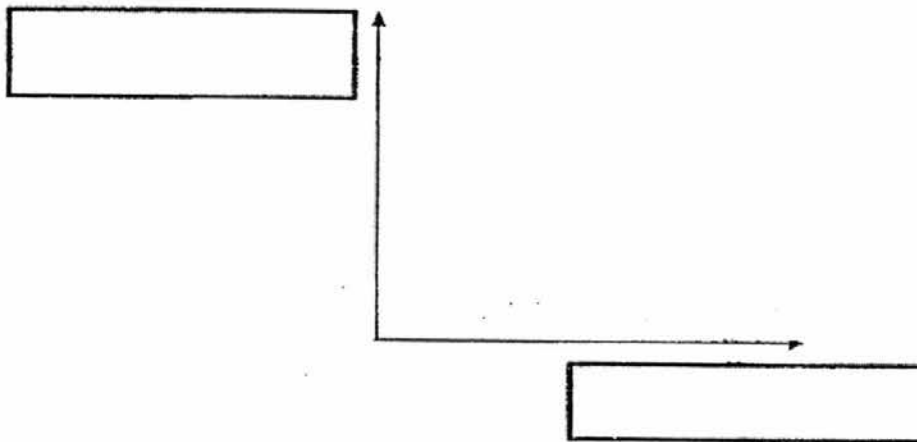

- (c) Fill in the boxes below with suitable words to show the stages of the life cycle of a plant.

[1]

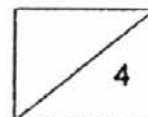
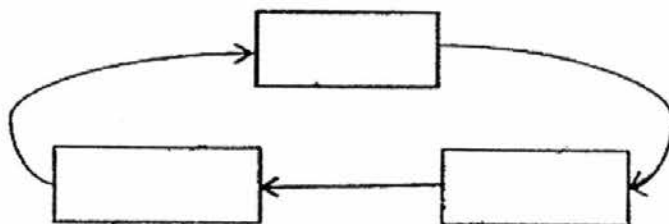

34. Le Xuan placed three plants of the same type in identical jars, each containing the same amount of water as shown below.

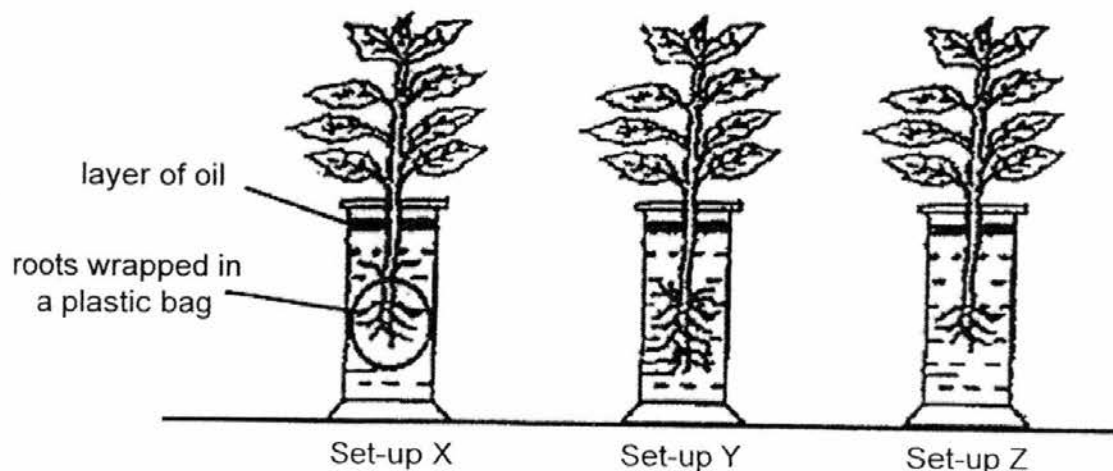

A layer of oil poured on top of the water to prevent any loss of water to the surroundings. The jars were put at the same location for five days.

- (a) Suggest what Le Xuan might observe about the plant in set-up X after five days. Explain your answer. [2]

- (b) Compare the difference between the water levels in set-ups Y and Z after five days? Explain your answer. [2]

35. Jiaqi set up an experiment using potatoes which were cut up into smaller pieces in two different ways as shown below.

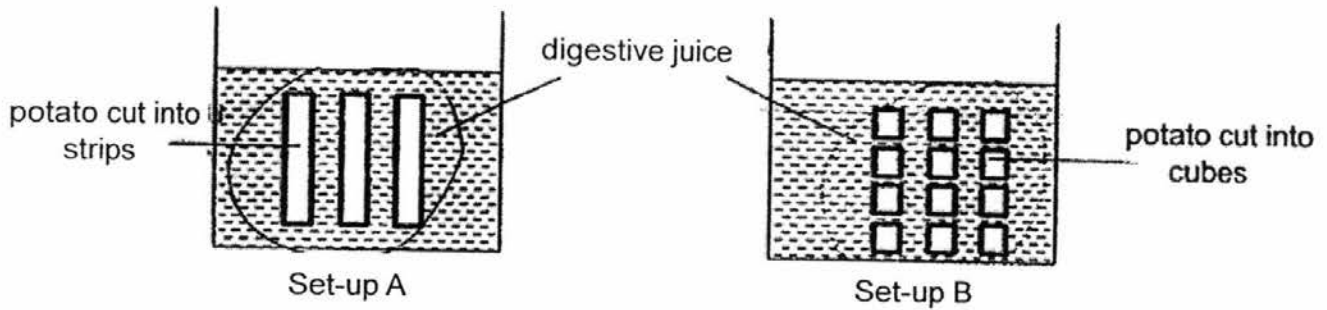

Jiaqi wanted to find out if the way the potato was cut would affect the amount of time taken for it to be completely digested.

- (a) Put a tick (✓) in the correct column to indicate the variables that she should change or keep the same in order to conduct a fair test. [2]

Variable	Variable to change	Variable to keep the same
mass of potato used		
type of potato used		
way potato is cut		
amount of digestive juice used		

- (b) If Jiaqi had conducted a fair test, would the potatoes in set-up A or set-up B take a shorter time to digest? Explain your answer. [1]

- (c) In which part of the digestive system will be the potatoes be fully digested and what happens to the digested potatoes? [1]

36. Melvin wanted to find out if the number of metal blocks in a container would affect the height of water in the container. He obtained a container of water as shown in diagram 1 below and measured h , the height of the water.

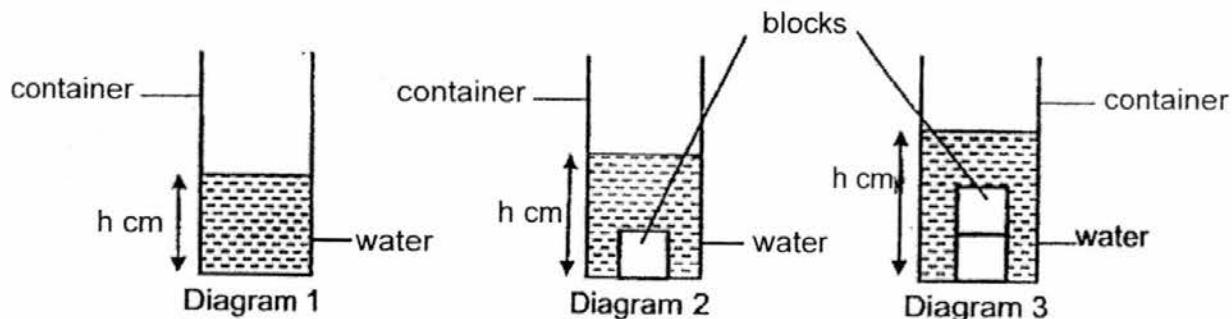

Melvin added similar metal blocks one at a time into the container of water as shown in diagrams 2 and 3. Each time, he measured h , the height of the water, and recorded his results in the table below.

Number of metal blocks added	h (cm)
0	5
1	9
2	13
3	17
4	17

(a) Explain why h increases as the number of blocks added increases from one to three. [1]

(b) State a property of metal that allowed Melvin to use the metal blocks to conduct the experiment above. [1]

(c) Give a possible reason why h remained the same when the number of blocks added increased from three to four. [1]

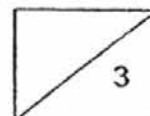

37. James poured liquid T into container A until it was filled to the top as shown below.

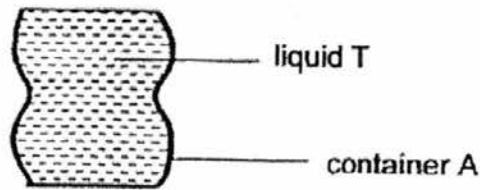

He then poured all of the liquid T in container A into container B as shown in the next diagram. Both containers A and B were at room temperature.



(a) Put a tick (✓) in the correct boxes below to indicate if the following properties of liquid T had changed or remained the same after it was poured from container A to container B. [2]

Property of liquid T	The property changed	The property remained the same.
volume		
mass		
shape		
temperature		

Container A could hold 500cm³ of liquid T when it was filled to the top. Plastic block W shown below also has a volume of 500cm³.

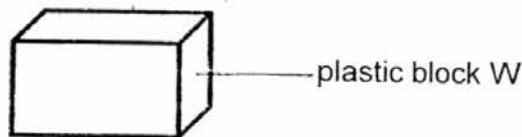

James tried to put plastic block W into container A but he could not.

(b) What property does liquid T have that plastic block W does not have to explain why container A could hold 500cm³ of liquid T but not plastic block W. [1]

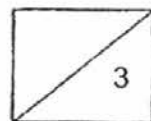

38. Ashwin wanted to find out if the number of batteries will affect the strength of an electromagnet. He had two set-ups as shown below.

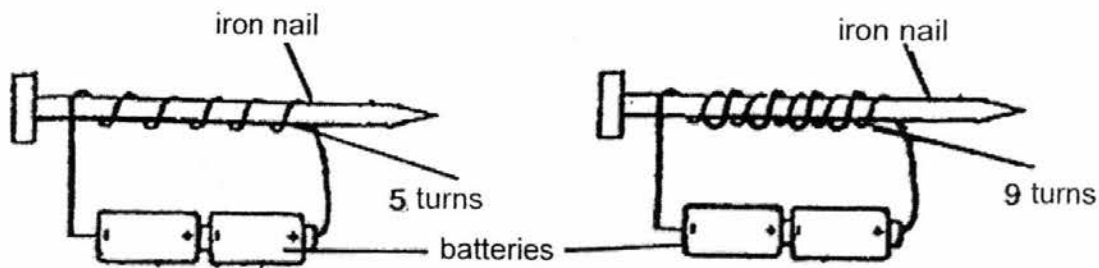

Ashwin's teacher said that his set-ups were not correct.

- (a) Suggest two changes Ashwin must make to his set-up so that he can achieve his aim. [2]

(i) _____

(ii) _____

- (b) What relationship will be observe between the number of batteries and the strength of an electromagnet? [1]

- (c) Can Ashwin carry out his experiment using a copper nail of the same thickness instead of an iron nail? Give a reason for your answer. [1]

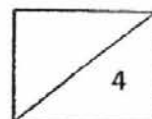

39. Kathy blew up a balloon and placed it in the refrigerator. After half an hour, she took the balloon out of the refrigerator and placed it on the table. She used a thermometer to measure the temperature of the surface of the balloon.

- (a) What changes would Kathy observe to the temperature of the surface of the balloon over time? Explain your answer.

[1]

- (b) Kathy also noticed that the balloon increased in size on its own when she took it out of the refrigerator and placed it on the table. Give an explanation for her observation.

[1]

Kathy then heated the balloon over a flame as shown in the diagram below. The balloon burst immediately.

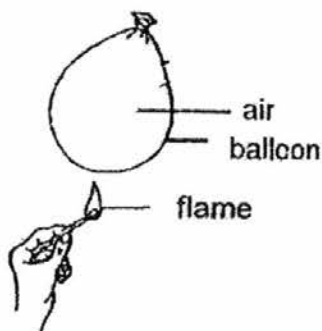

She took another similar balloon, filled it with some water and heated it under the flame. The balloon did not burst this time.

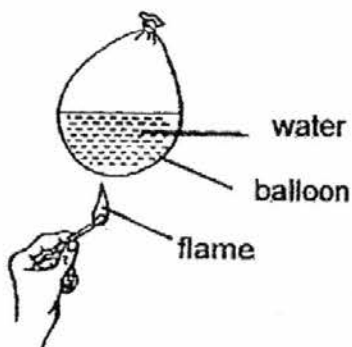

Question 39 continues on the next page.

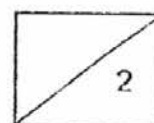

Question 39 continues.

- (c) What does the experiment tell you about the speed at which air and water conducts heat? [1]

- (d) Based on your answer in (c), explain why the balloon with water did not burst while the one filled with air burst when heated under the flame. [1]

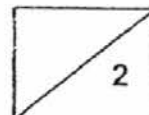

40. Kumar was performing a shadow puppet show by placing different puppets in between a screen and a torch. The screen is in a fixed position.

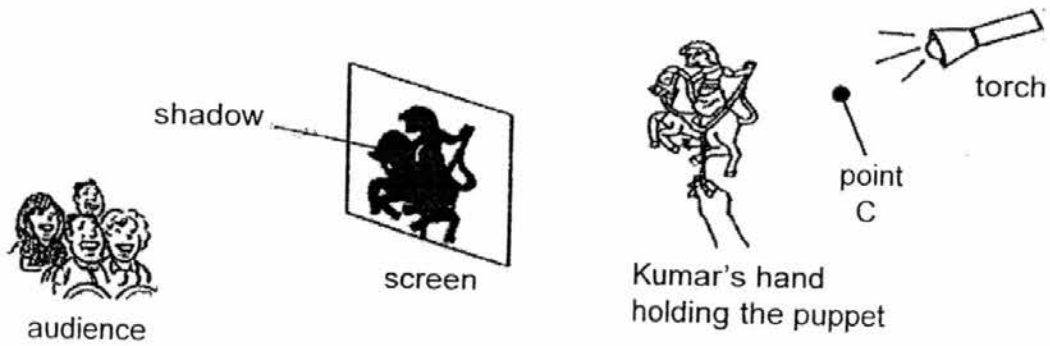

- (a) State two properties of light that enable the shadow to form on the screen. [2]

(i) _____

(ii) _____

- (b) Without removing the puppet, Kumar placed a large piece of clear glass at point C shown in the diagram above. He predicted that a dark shadow will still be formed on the screen. Do you agree with Kumar? Explain your answer. [1]

- (c) Suggest one way Kumar can make the shadow bigger without changing the puppet he is using. [1]

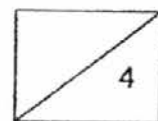

41. Jun Ming carried out an experiment to measure the amount of light reflected by four different types of paints, W, X, Y and Z. Four identical tin cans were each coated with one type of paint. The experiment was carried out in a dark room.

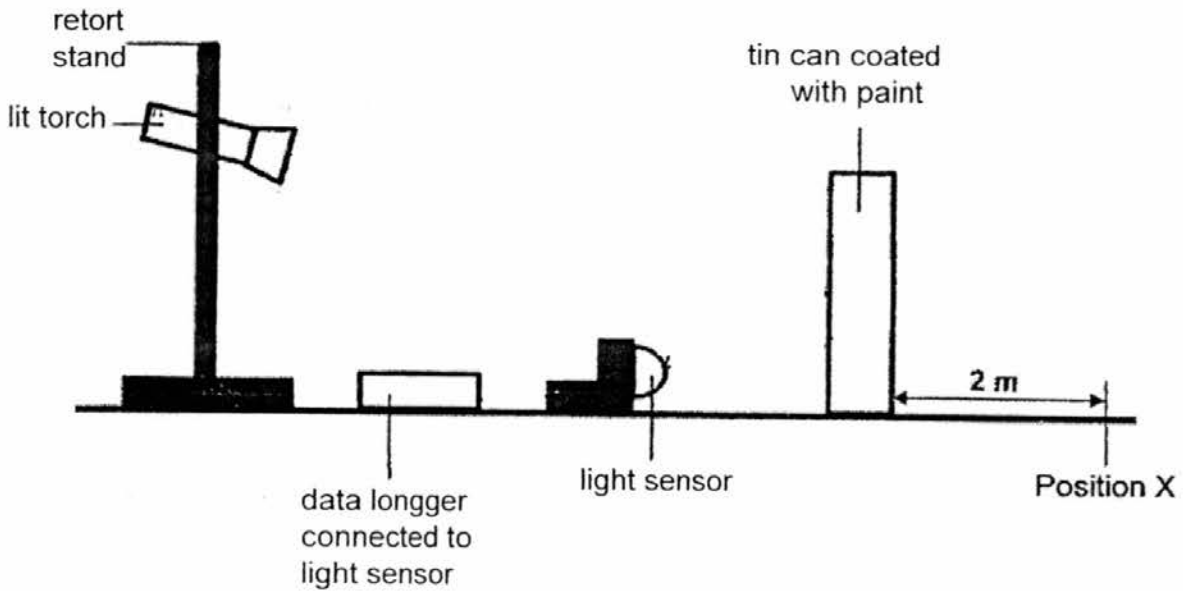

Jun Ming recorded the results of his experiment in the table below.

type of paint	amount of light detected by light sensor (units)
W	150
X	80
Y	210
Z	120

- (a) In the diagram above, draw the path of light to show how light from the torch could be reflected by the tin can and detected by the light sensor. [1]

- (b) What is the purpose of doing the experiment in a dark room? [1]

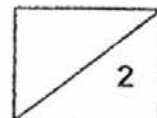

- (c) How would the amount of light detected by the light sensor change for each type of paint if the tin can is placed at position X? Explain your answer. [1]

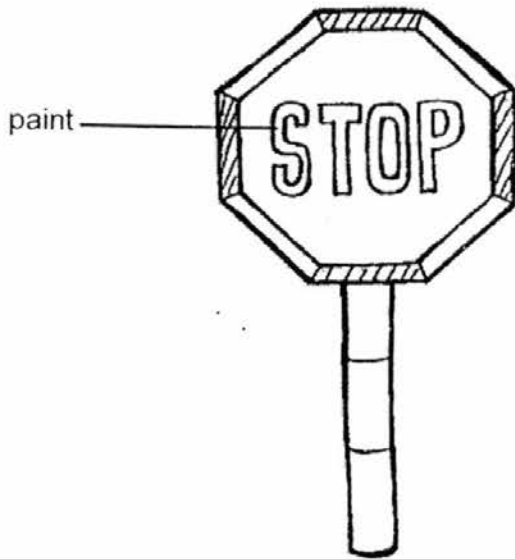

- (d) Which type of paint, W, X, Y or Z, would be most suitable for painting road signs like that shown above, so that drivers can see it clearly at night? Explain your answer. [1]

END OF PAPER

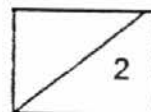

EXAM PAPER 2016 (P4)

SCHOOL : AI TONG

SUBJECT : SCIENCE

TERM : SA2

Q1	Q2	Q3	Q4	Q5	Q6	Q7	Q8	Q9	Q10
1	2	4	4	3	3	2	2	3	3
Q11	Q12	Q13	Q14	Q15	Q16	Q17	Q18	Q19	Q20
4	2	3	3	2	2	3	1	4	1
Q21	Q22	Q23	Q24	Q25	Q26	Q27	Q28		
3	4	1	4	4	3	1	4		

29)

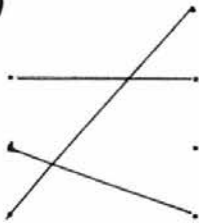

30)a)weaker

b)food

31)a)poor

b)good

32)a)force

b)magnetic

c)more pins than

33)a)The seed leaf had used up all the food for the plant to survive.

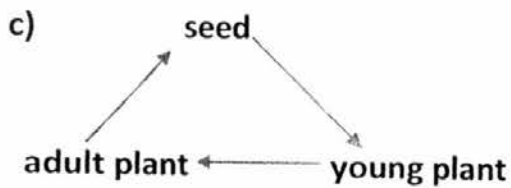
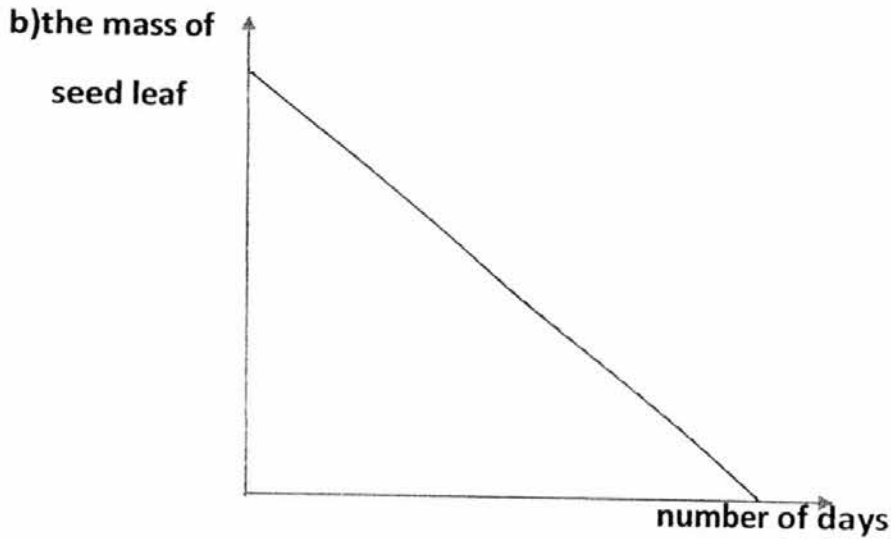

34)a)The plant will die as it cannot absorb water to survive.

b)The water levels in y is lower than Z. The plant in Y have roots which is more than Z. The roots can absorb more water and minerals salts than Z. Z have roots that are fewer.

35)a)

	✓
	✓
✓	
	✓

b)B. The potatoes in B have a greater exposed surface area for more digestive juice to act on.

c)Small intestine. The digested potato will be absorbed into the bloodstream.

36)a)The blocks take up spaces/has volume so the water moves up to give space to the blocks/displace the water.

b)The metal blocks sink in the water.

c)The water had reached the top of the container.

37)a)

	✓
	✓
✓	
	✓

b)Liquid T takes up the shape of its container.

38)a)i)He should ensure each setup has different number of batteries.

ii)Use the same number of coils around the iron nail.

b)As the number of batteries increases, the strength of an electromagnet increases.

c)No. Copper is a non-magnetic material and cannot be magnetised.

39)a)The temperature increases. The balloon gain heat from the surrounding.

b)The air in the balloon gained heat and expand.

c)Water is a better conductor of heat than air.

d)Water conducts heat away from the balloon faster than air. Thus the heat is not hot enough to melt the rubber.

40)a)i)Light travels n a only straight line.

ii)Light can be blocked.

b)Yes, I agree. The clear glass is transparent so the puppet will still block the light casting a dark shadow.

c)He can move the puppet further form the screen.

He can bring the puppet closer to the torch.

He can move the torch nearer to the puppet.

41)a)

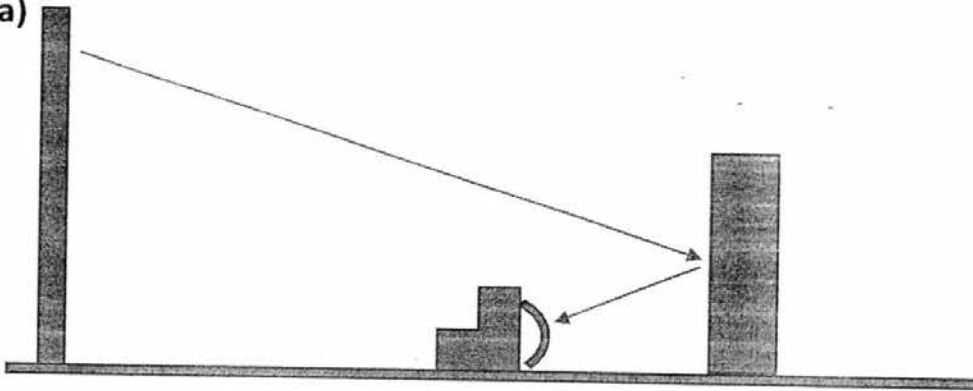

b) To ensure that no other light from the surrounding is detected by the light sensor.

c) The amount of light detected would decrease. At a further distance less light will reach the tin can/less light is reflected by the tin can to the light sensor.

d) Y. Y reflects the mist light.