

Index
No.

--	--	--	--	--	--

 -

--

Name : _____ ()

Class : Primary 6 SY / C / G / SE / P

Mathematics Teachers : EKY / ELAU / GAL / KRIS / WSW

**SINGAPORE CHINESE GIRLS' SCHOOL
PRELIMINARY EXAMINATION****PRIMARY 6**

22 Aug 2023

**MATHEMATICS
PAPER 1
(BOOKLET A)**

Additional materials: Optical Answer Sheet (OAS) Total Time for Booklets A and B: 1 h

INSTRUCTIONS TO CANDIDATES

1. Write your Index number in the boxes at the top right-hand corner.
2. Do not turn over this page until you are told to do so.
3. Follow all instructions carefully.
4. Answer all questions.
5. Use a 2B pencil to shade your answers on the Optical Answer Sheet (OAS).
6. The use of calculators in **NOT** allowed.

This booklet consists of 9 printed pages and 1 blank page.

Questions 1 to 10 carry 1 mark each. Questions 11 to 15 carry 2 marks each.
For each question, four options are given. One of them is the correct answer.
Make your choice (1, 2, 3 or 4) and shade your answer on the Optical Answer Sheet.

(20 marks)

1. In 652 009, what does the digit 2 stand for?

- (1) 20
- (2) 200
- (3) 2000
- (4) 20 000

2. Round off 49.456 to the nearest tenth.

- (1) 50.0
- (2) 49.5
- (3) 49.4
- (4) 49.0

3. Which one of the following is closest to 1?

- (1) $\frac{6}{7}$
- (2) $\frac{7}{8}$
- (3) $\frac{10}{9}$
- (4) $\frac{12}{11}$

4. In the given figure, how many pairs of lines are perpendicular to each other?

- (1) 1
 (2) 2
 (3) 3
 (4) 4

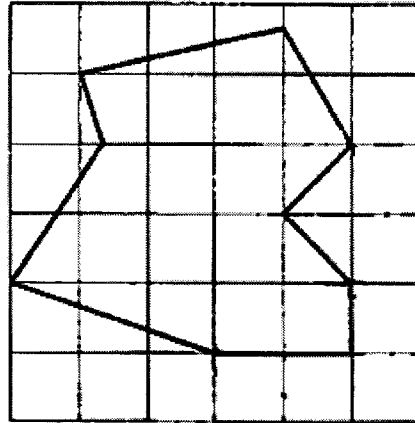

5. In the number line, which mixed number is represented by X?

- (1) $2\frac{2}{3}$
 (2) $2\frac{5}{6}$
 (3) $3\frac{1}{6}$
 (4) $3\frac{2}{3}$

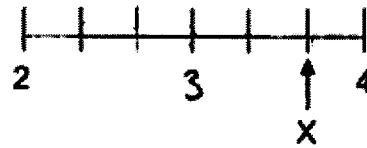

6. The table below shows the number of pupils with the following Math scores.

Math scores	85	88	90	91	95	98	100
Number of pupils	5	3	2	2	3	2	1

Prizes were given to the top 8 pupils. Gwen won a prize. What was the lowest she could have scored?

- (1) 88
 (2) 90
 (3) 91
 (4) 95

7. The figure below is not drawn to scale. PQRT is a parallelogram. $\angle TPQ = 115^\circ$ and $\angle SQP = 43^\circ$. Find $\angle RQS$.

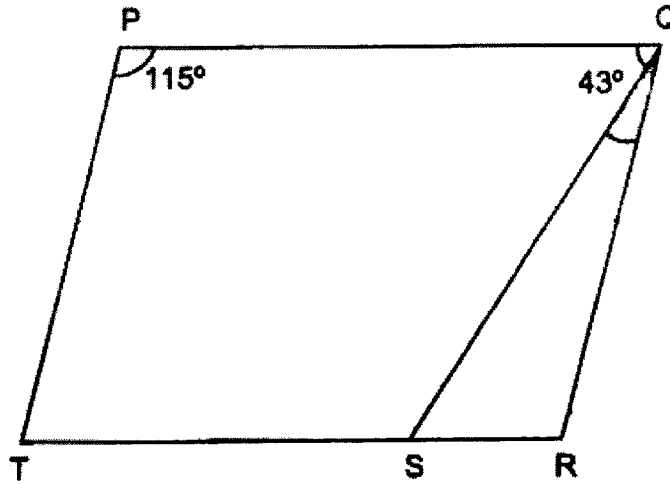

- (1) 22°
 (2) 48°
 (3) 50°
 (4) 72°

8. Arrange these values from the largest to the smallest.

1.005 l	1 l 50 ml	1550 ml	$1\frac{1}{2}$ l
---------	-----------	---------	------------------

- | | <u>Largest</u> | | | <u>Smallest</u> |
|-----|------------------|------------------|-----------|------------------|
| (1) | $1\frac{1}{2}$ l | 1.005 l | 1 l 50 ml | 1550 ml |
| (2) | $1\frac{1}{2}$ l | 1550 ml | 1.005 l | 1 l 50 ml |
| (3) | 1550 ml | $1\frac{1}{2}$ l | 1 l 50 ml | 1.005 l |
| (4) | 1 l 50 ml | 1.005 l | 1550 ml | $1\frac{1}{2}$ l |

9. The figure below shows a prism.

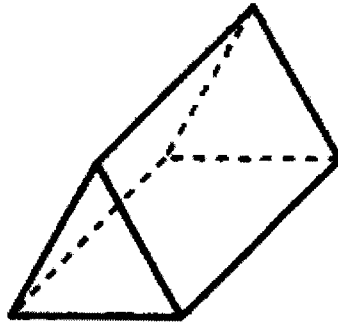

Which one of the following is a net of the prism?

(1)

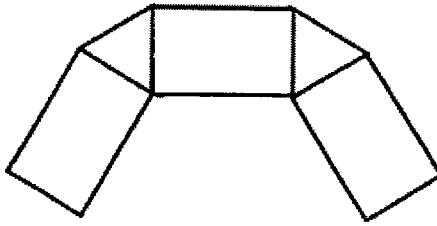

(2)

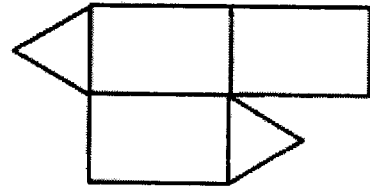

(3)

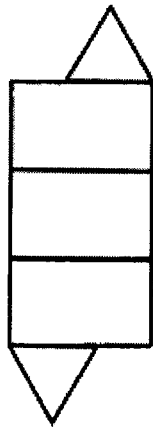

(4)

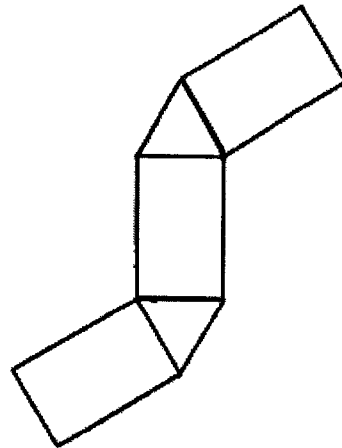

10. The pie chart shows the mode of transport taken by Primary Six students to school.
 $\frac{1}{2}$ of the students take the train to school.

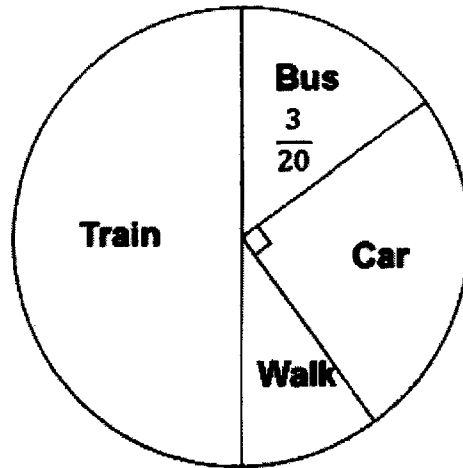

Which of the following bar graphs best represents the information in the pie chart?

(1)

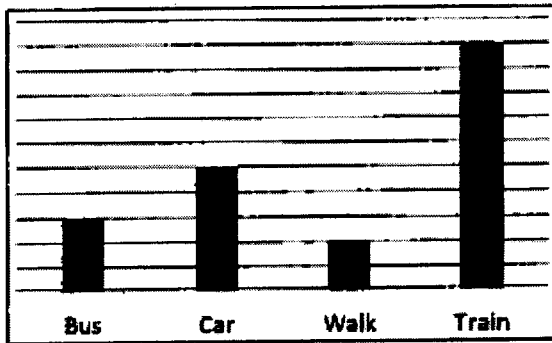

(2)

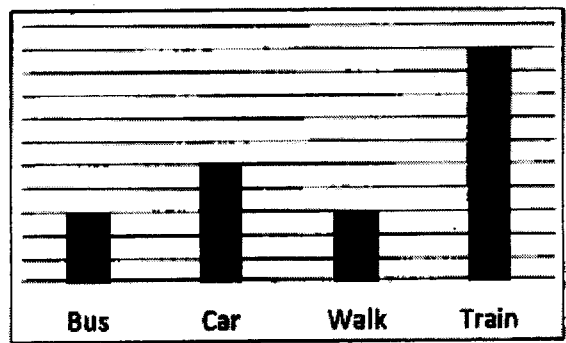

(3)

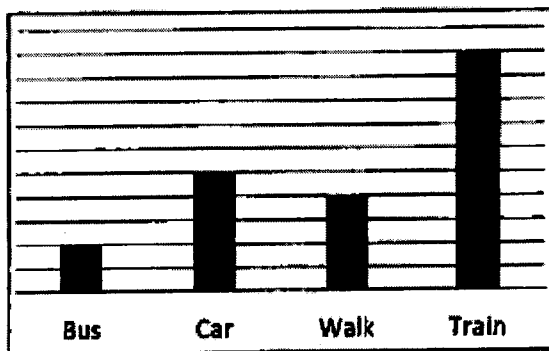

(4)

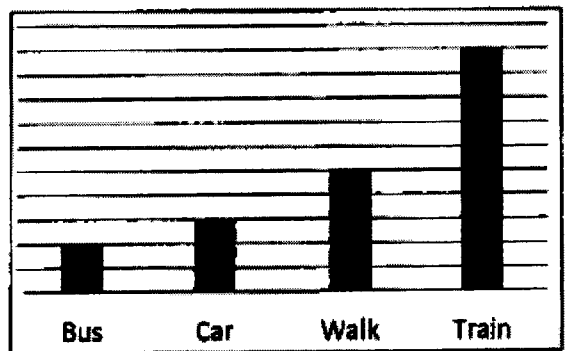

11. The total mass of Ben and Jerry is 100 kg.
Jerry weighs 7.8 kg lighter than Ben.
How heavy is Jerry?

- (1) $(100 + 2 + 7.8)$ kg
(2) $(100 - 7.8 + 2)$ kg
(3) $(100 + \frac{7.8}{2})$ kg
(4) $(\frac{100 - 7.8}{2})$ kg

12. Adam Electronics Store gave a storewide discount of 20% during its annual sale. As a member of the store, Ming Hui is entitled to an additional 10% discount on the discounted price. He bought a camera during the sale.

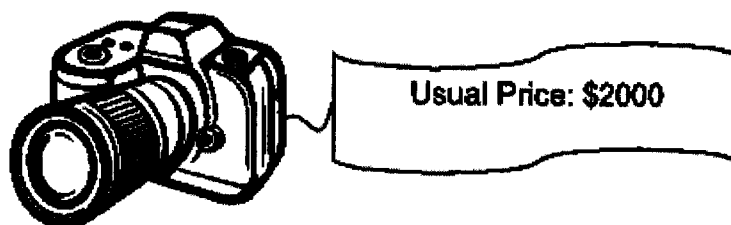

How much did Ming Hui pay for the camera?

- (1) \$600
(2) \$1400
(3) \$1440
(4) \$1600

13. The figure shows 4 points (A, B, C and D) in a square grid.

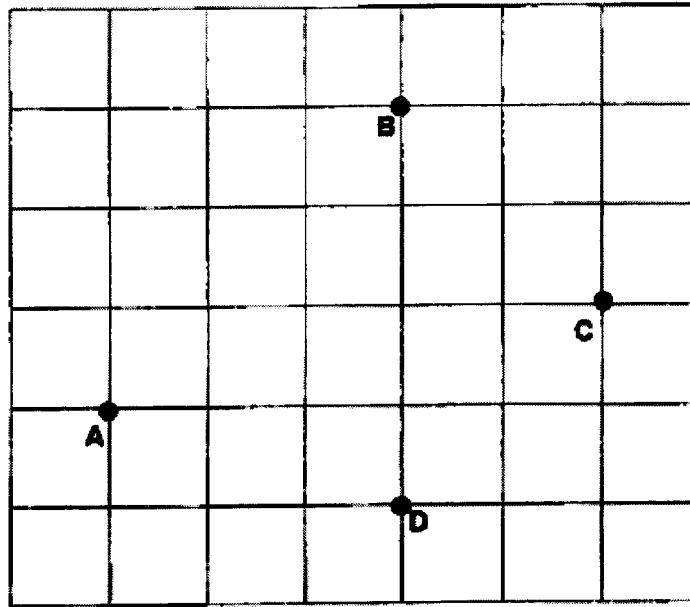

Which of the following statements is false?

- (1) D is south of B.
- (2) D is south-west of C.
- (3) A is north-west of D.
- (4) B is north-west of C.

14. Study the table below.

	A	B	C	D
Row 1	4	5	6	7
Row 2	8	9	10	11
Row 3	12	13	14	15
⋮				
Row n				

Which algebraic expression is for Row n , Column C?

- (1) $n + 4$
(2) $n + 14$
(3) $4n + 2$
(4) $4n$
15. A baker can either bake 100 big cookies or 150 small cookies using the same amount of ingredients. After baking 80 big cookies, what is the maximum number of small cookies he can bake with the remaining ingredients?

- (1) 20
(2) 30
(3) 70
(4) 120

(Go on to Booklet B)

BLANK PAGE

Index
No. -

Name : _____ ()

Class : Primary 6 SY / C / G / SE / P

Mathematics Teachers : EKY / ELAU / GAL / KRIS / WSW



**SINGAPORE CHINESE GIRLS' SCHOOL
PRELIMINARY EXAMINATION**

PRIMARY 6

22 Aug 2023

**MATHEMATICS
PAPER 1
(BOOKLET B)**

Total Time for Booklets A and B: 1 h

INSTRUCTIONS TO CANDIDATES

1. Do not turn over this page until you are told to do so.
2. Follow all instructions carefully.
3. Answer all questions.
4. Use a dark blue or black ballpoint pen to write your answers in the space provided for each question.
5. Do not use correction fluid/tape or highlighters.
6. The use of calculators in **NOT** allowed.

	Max Mark	Marks attained
Booklet B	25	

This booklet consists of 8 printed pages.

Booklet B

Questions 16 to 20 carry 1 mark each. Write your answers in the spaces provided.
For questions which require units, give your answers in the units stated. (5 marks)

Do not write in
this space

16. Find the value of 82 hundreds, 4 tenths and 7 thousandths.

Ans: _____

17. Hui Ling paid \$5 for 20 pencils. What was the cost of each pencil in cents?

Ans: _____ ¢

18. Find the value of $7 - 3.18$.

Ans: _____

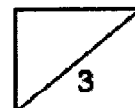

19. A ribbon is 148.6 m long. It is cut into 200 equal pieces. How long is each piece of ribbon?

Do not write in
this space

Ans: _____ m

20. Find the value of $\frac{4}{9} + \frac{2}{5}$.

Give your answer as a mixed number in its simplest form.

Ans: _____

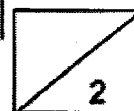

Questions 21 to 30 carry 2 marks each. Show your working clearly and write your answers in the spaces provided. For questions which require units, give your answers in the units stated. **(20 marks)**

Do not write in this space

21. A can of mushroom soup costs \$3.20 and a bundle of 3 cans of mushroom soup costs \$8. Diane wants to buy 20 cans of mushroom soup. What is the least amount of money she needs?

Ans: \$ _____

22. Siti has a string that is 5 m long. She cuts the string into equal pieces, each measuring $\frac{3}{5}$ m. Find the length of the remaining piece of string.

Express your answer in metres.

Ans: _____ m

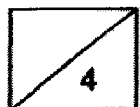

23. Last month, Rachel saved \$90 and spent the rest of her pocket money. If she increased her spendings by 40%, her savings would decrease by 20%. How much was her pocket money?

Do not write in
this space

Ans: \$ _____

-
24. Jane is p years old. She is twice as old as her brother. How old is her brother in 8 years' time? Express your answer in terms of p .

Ans: _____ years old

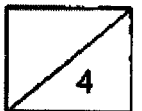

25. 30 students shared a box of stickers equally. 6 students gave up their shares and their stickers were distributed equally to the rest of the students. As a result, the rest of the students received 2 more stickers each. How many stickers did each student have at first?

Do not write in
this space

Ans: _____

-
26. Jenny took 4 hours to paint a room.
Bala took 5 hours to paint an identical room.
At this rate, how long will they take if they paint such a room together?

Ans: _____ h

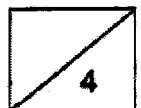

27. The figure below shows two rectangular tanks, X and Y. 540 cm³ of water was poured into X and Y until the heights of the water levels were the same. What was the height of the water level in each tank?

Do not write in this space

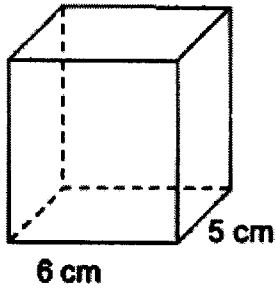

Tank X

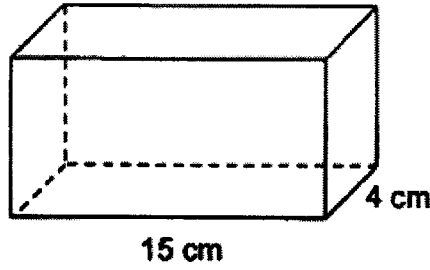

Tank Y

Ans: _____ cm

28. A rectangular piece of paper was folded to form the figure as shown as below. Find the perimeter of the rectangular piece of paper when it was unfolded.

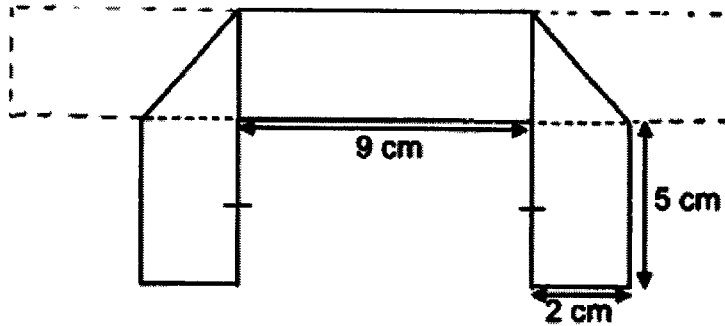

Ans: _____ cm

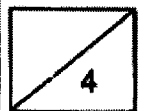

Do not write in
this space

29. Thomas and Siti had cookies in the ratio 3 : 7. After Thomas bought another 42 cookies and Siti ate 18 cookies of her own, they had an equal number of cookies left. How many cookies did Siti have at first?

Ans: _____

-
30. Ben and Joel have \$288 altogether. $\frac{1}{4}$ of Ben's money is \$18 more than $\frac{1}{5}$ of Joel's money. How much does Joel have?

Ans: \$ _____

End of Booklet B

Index
No. -

Name : _____ ()

Class : Primary 6 SY / C / G / SE / P

Mathematics Teachers : EKY / ELAU / GAL / KRIS / WSW

	SINGAPORE CHINESE GIRLS' SCHOOL PRELIMINARY EXAMINATION	
	PRIMARY 6	22 Aug 2023
	MATHEMATICS PAPER 2	
		Time: 1 hour 30 minutes

INSTRUCTIONS TO CANDIDATES

1. Do not turn over this page until you are told to do so.
2. Follow all instructions carefully.
3. Answer all questions.
4. Use a dark blue or black ballpoint pen to write your answers in the space provided for each question.
5. Do not use correction fluid/tape or highlighters.
6. The use of an approved calculator is allowed.

		Max Mark	Marks attained
Paper 1	Booklet A	20	
	Booklet B	25	
Paper 2		55	
Total Marks		100	

Parent's Signature

This booklet consists of 15 printed pages and 1 blank page.

Questions 1 to 5 carry 2 marks each. Show your working clearly and write your answers in the spaces provided. For questions which require units, give your answers in the units stated. (10 marks)

Do not write in this space

1.

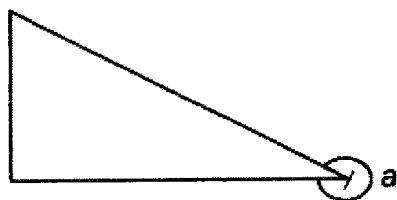

Measure and write down the size of angle a.

Ans: _____ °

2. Ken and Ben have the same number of sweets. Ken ate $\frac{1}{2}$ of his sweets and gave $\frac{1}{2}$ of his remaining sweets to Ben. After that, Ben has 35 sweets. How many sweets did Ken have at first?

Ans: _____

3. Mrs Lim bought a blender at 20% discount during a sale. She paid \$90.72 including 8% GST. What is the original price of the blender?

Ans: \$ _____

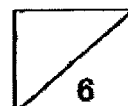

4. The pie chart and the table below show the number of each type of stickers sold in two shops, A and B.

Do not write in this space

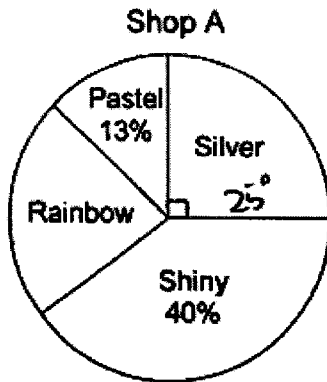

Shop B

Pastel	10%
Silver	25%
Rainbow	50%
Shiny	15%

Each statement is either true, false or not possible to tell from the information given. Put a tick (✓) to indicate your answer.

Statement	True	False	Not possible to tell
Shop A sold 100 stickers.			
Shop A sold more pastel stickers than Shop B.			
25% of the stickers Shop A sold are rainbow stickers.			

5. Mrs Tan prepared some sticks of satay and muffins for her students. The ratio of the number of sticks of satay prepared to the number of muffins prepared was 3 : 1. Each student was given 5 sticks of satay and 2 muffins. There were 52 sticks of satay left after all the muffins were given out. How many students are there?

Ans: _____



For questions 6 to 17, show your working clearly and write your answers in the spaces provided. The number of marks available is shown in brackets [] at the end of each question or part-question. (45 marks)

Do not write in this space

6. The table shows the cost of parking in SC Mall.

	1 st hour	Subsequent 30 minutes or part thereof
Monday to Thursday	\$2.70	\$1.30
Friday to Sunday	\$2.60	\$1.89

(a) On Tuesday, Mr Salim parked his car for 3 hours in the carpark starting from 8.30 a.m. How much did he pay for carpark charges?

Ans: (a) _____ [1]

(b) Jamie was charged \$12.05 for parking her car in the mall from 10 a.m. on a Saturday. What is a possible time she left the mall?

Ans: (b) _____ [2]

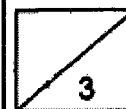

7. The bar graph below shows the number of cars sold from January to March.

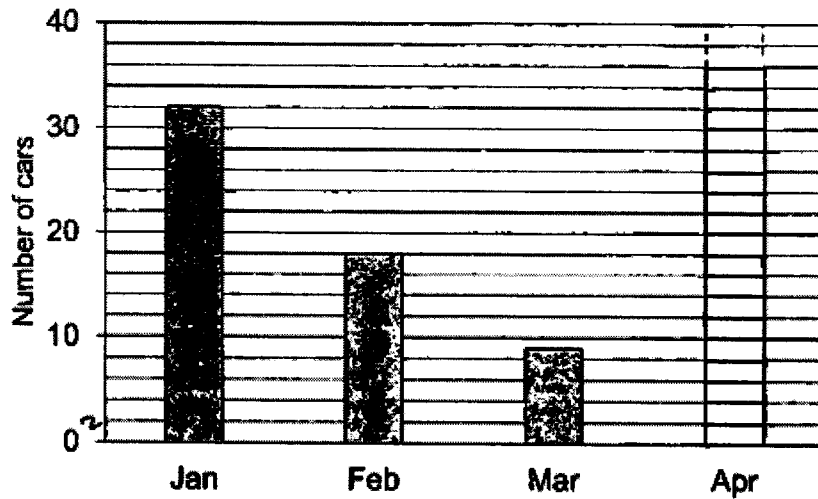

Do not write in
this space

- (a) The number of cars sold in March is $\frac{1}{4}$ of the number of cars sold in April.

Draw and shade the bar representing the number of cars sold in April. [1]

- (b) What is the average number of cars sold from January to April?

Ans: _____ [2]

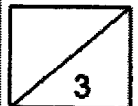

8. The radius of Circle A is 3 times the radius of Circle B.
 Circle A makes 12 revolutions to roll from X to Y. (Take $\pi = 3.14$)

Do not write in
 this space

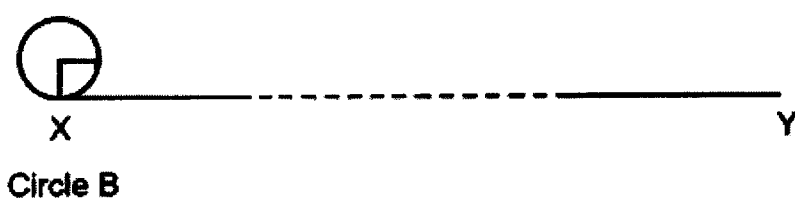
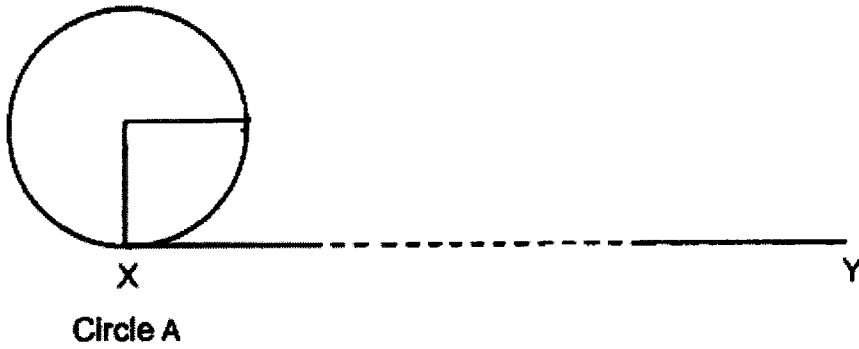

(a) How many revolutions will Circle B take to roll from X to Y?

Ans: _____ [1]

(b) The radius of Circle A is 12 cm. What is the length of XY?

Ans: _____ [2]

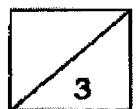

9. In the figure below, not drawn to scale, EFGH is a square overlapping a trapezium ABCD. $AB \parallel DC$, $\angle CHG = 25^\circ$ and $\angle IFC = 33^\circ$.

Do not write in
this space

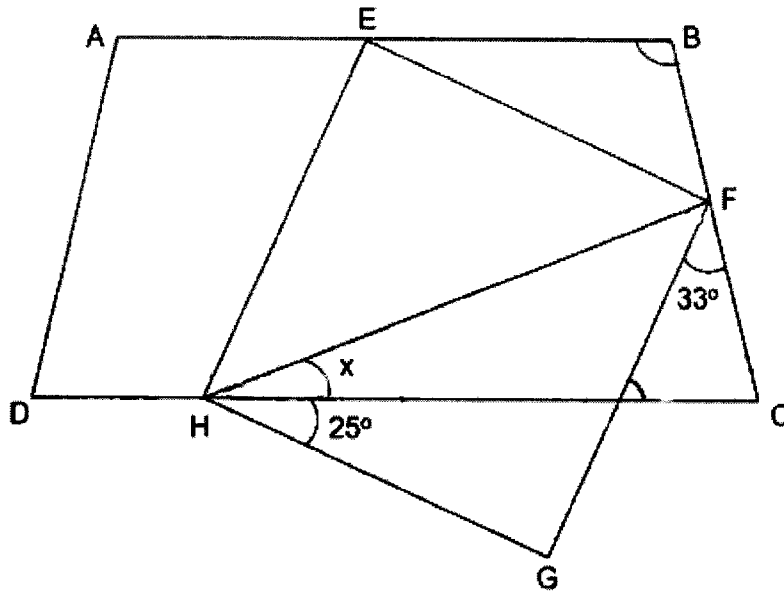

(a) Find $\angle x$.

Ans: (a) _____ [1]

(b) Find $\angle EBF$.

Ans: (b) _____ [3]

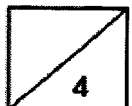

10. A car and a bike set off from Town B in opposite directions at 09 30. The car travelled towards Town A at a constant speed of 80 km/h while the bike travelled towards Town C at a constant speed of 62 km/h. When the car reached Town A at 12 30, the bike was still 28 km away from Town C.

Do not write in
this space

(a) How far did the car travel?

Ans: (a) _____ [1]

(b) What was the distance between Town A and Town C?

Ans: _____ [2]

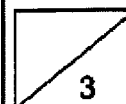

11. En En packed all 732 cookies into a mixture of large and small boxes. He filled each large box with 30 cookies and each small box with 22 cookies. All the boxes are filled with no cookies left over.

What is the least number of boxes used by En En?

Do not write in
this space

Ans: _____ [3]

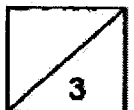

12. In the figure below, ACE is a triangle, BDEF is a parallelogram, BFG is an isosceles triangle and AE parallel to BD.

Do not write in
this space

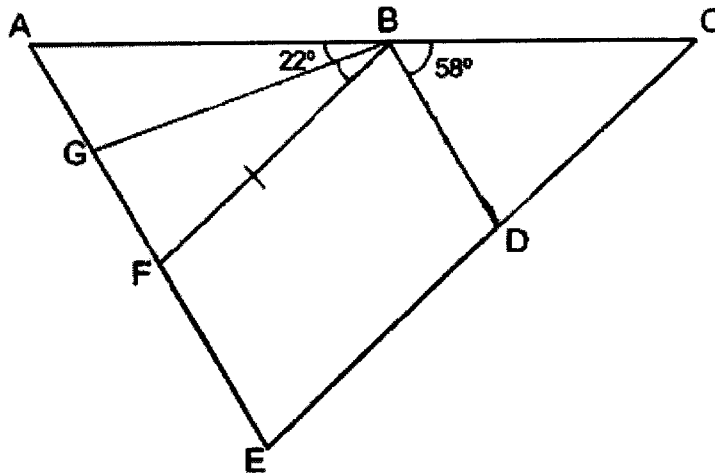

- (a) Find $\angle GBD$.

Ans: (a) _____ [1]

- (b) Find $\angle GBF$.

Ans: (b) _____ [2]

- (c) Find $\angle BDC$.

Ans: (c) _____ [1]

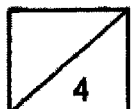

13. Freddy had a rectangular block measuring 10 cm by 3 cm by 6 cm. He painted all the faces of the block.

Do not write in this space

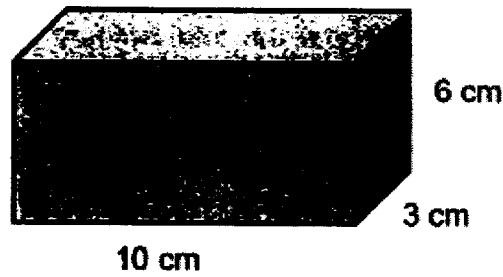

- (a) Calculate the total painted area.

Ans: (a) _____ [2]

- (b) Freddy wants to cut the largest possible cube from the rectangular block. What is the greatest number of such cubes he can cut from the rectangular block?

Ans: (b) _____ [2]



14. Tank A and Tank B shown below are empty at first. Tank A has a base area of 441 cm^2 . When water was poured into Tank A, some of the water flowed into Tank B through the hole which was just above Tank B. Tank B was $\frac{4}{7}$ filled and the total amount of water in both tanks became 5324 cm^3 .

Do not write in
this space

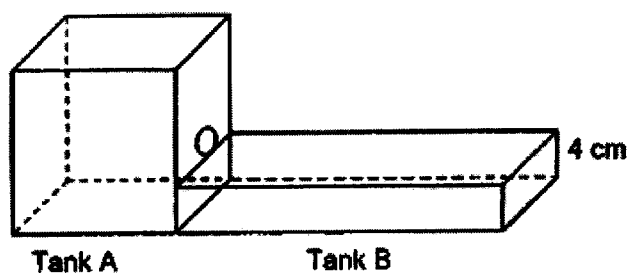

- (a) Find the amount of water in Tank A.

Ans: (a) _____ [2]

- (b) What is the capacity of Tank B?

Ans: (b) _____ [3]

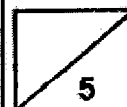

15. There were 600 adults attending a concert at Fort Canning Park. After $\frac{5}{8}$ of the men and 165 of the women left the concert, the ratio of the number of the remaining men to the number of remaining women became 1 : 7. What was the ratio of the number of men to the number of women at first?
Leave your answer in its simplest form.

Do not write in
this space

Ans: _____ [4]

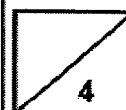

16. The figure below is formed by 2 quadrants and a rectangle overlapping one another. The radius of the smaller quadrant is 10 cm. Find the area of the shaded part of the figure. (Take $\pi = 3.14$)

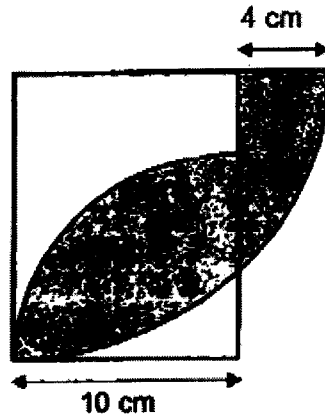

Do not write in this space

Ans: _____ [5]

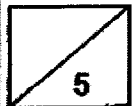

17. Mr Wong bought a number of red, blue and green balloons. The ratio of the number of red balloons to the number of blue balloons to the number of green balloons was $15 : 12 : 28$. After bursting some green balloons and buying another 168 blue balloons, he found that there was a decrease of 25% in the total number of blue and green balloons. In the end, the number of red, blue and green balloons he had was 1440.

Do not write in
this space

(a) How many balloons did Mr Wong have at first?

Ans: (a) _____ [2]

(b) How many green balloons burst?

Ans: (b) _____ [2]

End of Paper 2

~ Please check your work thoroughly. ~

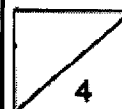

BLANK PAGE

SCHOOL : SCGS SCHOOL
LEVEL : PRIMARY 6
SUBJECT : MATH
TERM : 2023 PRELIM

PAPER 1 BOOKLET A

Q 1	Q2	Q3	Q4	Q5	Q6	Q7	Q8	Q9	Q10
3	2	4	2	4	3	1	3	4	1

Q 11	Q12	Q13	Q14	Q15
4	3	3	3	2

PAPER 1 BOOKLET B

Q16) 8200.407
Q17) 25c
Q18) 3.82
Q19) 0.743m
Q20) $1\frac{1}{9}$
Q21) \$54.40
Q22) $\frac{1}{5}$ m
Q23) \$135
Q24) $\frac{p}{2} + 8$ years old
Q25) $30 - 6 = 24$ $2 \times 24 = 48$ $48 \div 6 = 8$
Q26) $2\frac{2}{9}h$
Q27) $X \rightarrow 6 \times 5 = 30$ $Y \rightarrow 15 \times 4 = 60$ $60 + 30 = 90$ $\frac{540}{90} = 6$ cm
Q28) 50cm

Q29) 105
Q30) \$120

PAPER 2

Q1) $180 + 153 = 333^\circ$										
Q2) $5u \rightarrow 35$ $1u \rightarrow 35 \div 5 = 7$ $4u \rightarrow 7 \times 4 = 28$										
Q3) $90.72 \div \frac{108}{100} = 84$ $84 \div \frac{80}{100} = \105										
Q4) <table border="1" style="margin-left: 20px;"> <tr> <td></td> <td></td> <td>✓</td> </tr> <tr> <td></td> <td></td> <td>✓</td> </tr> <tr> <td></td> <td>✓</td> <td></td> </tr> </table>			✓			✓		✓		
		✓								
		✓								
	✓									
Q5) $2u = 52$ $1u = 26$ $26 \times 2 = 52$										
Q6) a) \$7.90 b) 1.30 p.m.										
Q7) a) b) $32 + 18 + 9 + 36 = 95$ $95 \div 4 = 23.75$										
<table border="1" style="margin-left: 20px;"> <caption>Number of cars by month</caption> <thead> <tr> <th>Month</th> <th>Number of cars</th> </tr> </thead> <tbody> <tr> <td>Jan</td> <td>32</td> </tr> <tr> <td>Feb</td> <td>18</td> </tr> <tr> <td>Mar</td> <td>9</td> </tr> <tr> <td>Apr</td> <td>36</td> </tr> </tbody> </table>	Month	Number of cars	Jan	32	Feb	18	Mar	9	Apr	36
Month	Number of cars									
Jan	32									
Feb	18									
Mar	9									
Apr	36									

Q8)	<p>a) $3u = 12$ $1u = 12 \div 3 = 4$ $9u = 4 \times 9 = 36$</p> <p>b) $D = 12 \times 2 = 24$ $3.14 \times 24 = 75.36$ $75.36 \times 12 = 904.32 \text{ cm}$</p>
Q9)	<p>a) $\angle X = 90 - 45 - 25 = 20^\circ$</p> <p>b) $\angle HIG \rightarrow 180 - 90 - 25 = 65$ $\angle ICF \rightarrow 180 - 65 - 33 = 82$ $\angle EBF \rightarrow 180 - 82 = 98^\circ$</p>
Q10)	<p>a) 240km b) 454km</p>
Q11)	<p>6 box $\rightarrow 22 \times 6 = 132$ $732 - 132 = 600$ $600 \div 30 = 20$ 6 small + 20 big = 26 box</p>
Q12)	<p>a) $\angle GBD \rightarrow 180 - 58 - 22 = 100^\circ$</p> <p>b) $\angle BGF \rightarrow 180 - 100 = 80$ $\angle GBF \rightarrow 180 - 80 - 80 = 20^\circ$</p> <p>c) $\angle BFF \rightarrow 180 - 80 = 100$ $\angle BDC \rightarrow 180 - 100 = 80^\circ$</p>
Q13)	<p>a) $120 + 36 + 60 = 216 \text{ cm}^2$</p> <p>b) $10 \div 3 = 3 \text{ R}1$ $3 \div 3 = 1$ $6 \div 3 = 2$ $3 \times 1 \times 2 = 6$</p>

Q14)	a) $441 \times 4 = 1764 \text{ cm}^3$ b) $5324 - 1764 = 3560$ $\frac{4}{7} \rightarrow 356$ $\frac{4}{7} \rightarrow 3560 \div 4 = 890$ $\frac{7}{7} \rightarrow 890 \times 7 = 6230 \text{ cm}^3$
Q15)	1:4
Q16)	92.36cm ²
Q17)	a)1760 b)488