

Index No.

--	--	--	--	--	--

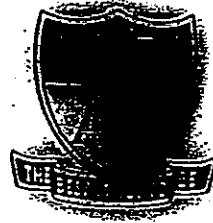

Anglo-Chinese School (Junior)
Anglo-Chinese School (Primary)

COMBINED PRELIMINARY EXAMINATION 2012

SCIENCE

BOOKLET A

Monday

27th August 2012

1 hour 45 minutes

Name : _____ ()

Class : P6. _____

INSTRUCTIONS TO PUPILS

DO NOT TURN OVER THE PAGES UNTIL YOU ARE TOLD TO DO SO

Follow all instructions carefully.

There are 30 questions in this booklet.

Answer ALL questions.

INFORMATION FOR PUPILS

The total marks for this booklet is 60.

The total time for Booklets A and B is 1 hour 45 minutes.

This question paper consists of 19 printed pages. (Inclusive of cover page)

For each question from 1 to 30, four options are given. One of them is the correct answer. Choose the correct option (1, 2, 3 or 4) and shade the correct oval on the Optical Answer Sheet (OAS) provided. (60 marks)

- 1 Four boys set up some circuits to find out if objects, P, Q, R, S and T, conduct electricity. The diagrams below show how the various circuits were connected and the results of the experiment.

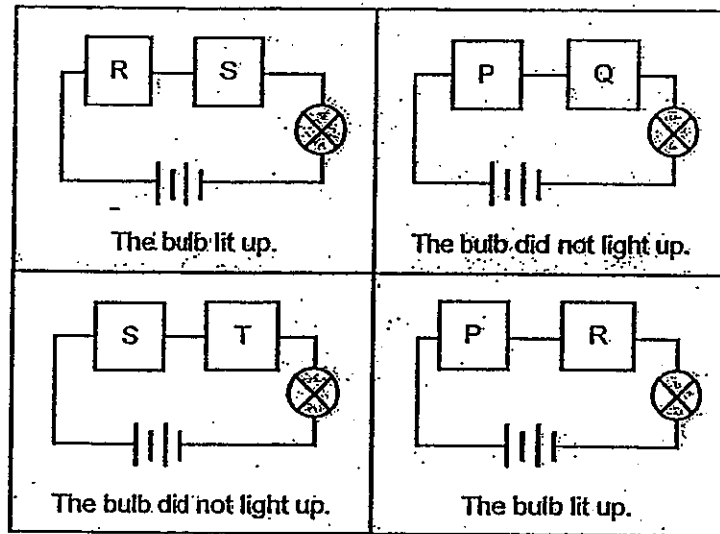

Based on their observations, the boys made some conclusions. Who made the correct conclusion?

Euan	P, R and S conduct electricity.
Attlee	Q, R and S conduct electricity.
Clement	Q and T do not conduct electricity.
Jeremiah	P, Q, S and T do not conduct electricity.

- (1) Euan and Clement
- (2) Attlee and Clement
- (3) Euan and Jeremiah
- (4) Attlee and Jeremiah

2 Janan has an incomplete circuit set-up as shown below. The three-way switch was made using four pins and a metal strip.

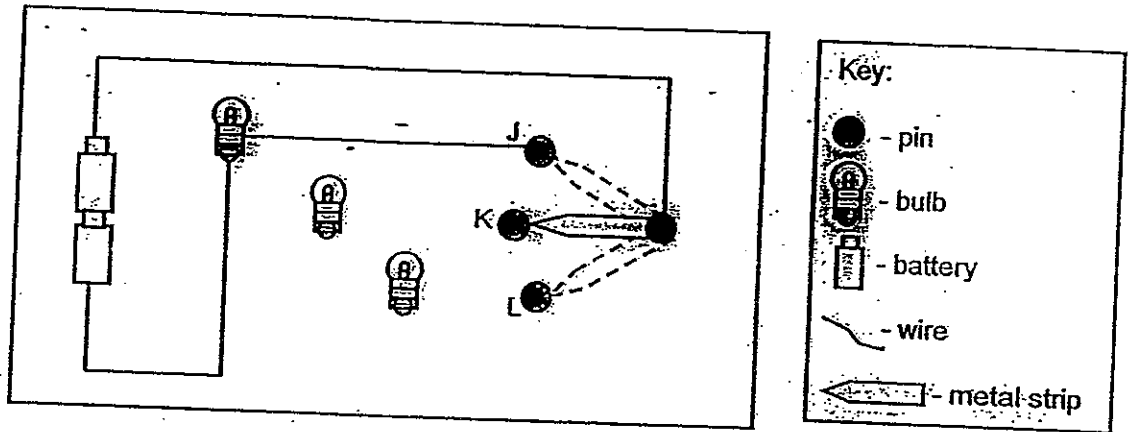

He had to add four wires to the circuit so that when the metal strip is moved to touch the pins (J, K and L), only one bulb will light up at a time. Which diagram correctly shows how Janan should connect the four wires?

(1)

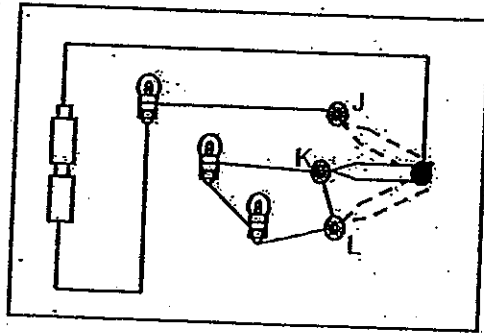

(2)

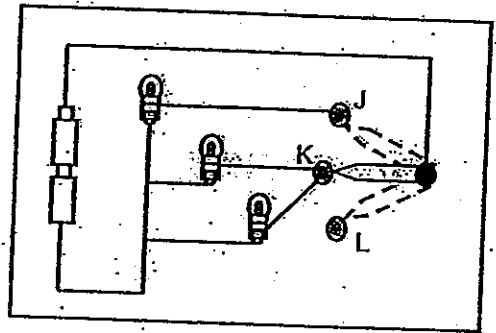

(3)

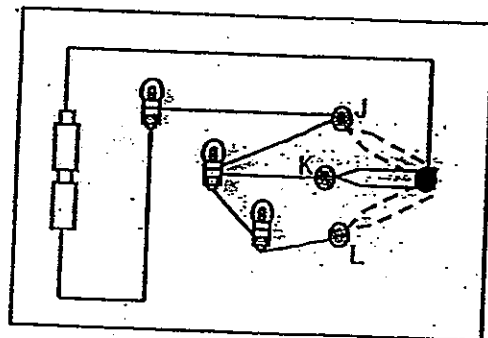

(4)

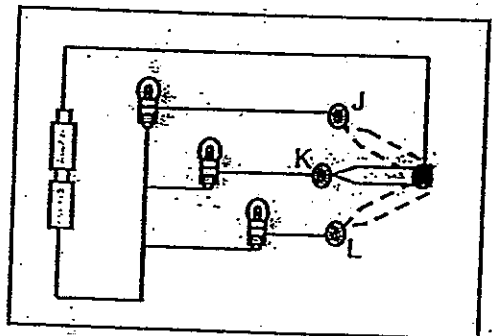

- 3 Sean used two switches, R and S, in four different circuits. He used similar new bulbs and new batteries of similar electrical power in each circuit. The table below shows one set of the results that he obtained.

Switch R	Switch S	Number of bulbs that lit up
closed	closed	2
closed	opened	1
opened	closed	2
opened	opened	0

Which of the following circuits will produce the above set of results?

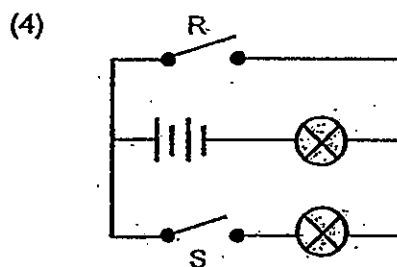
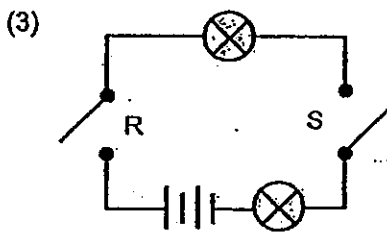
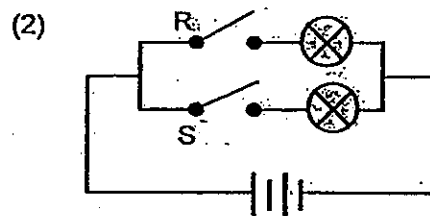
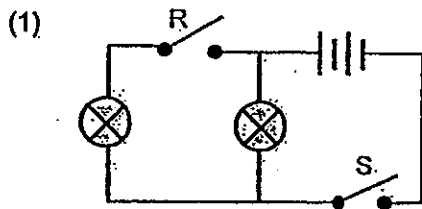

- 4 The diagram below shows the digestive system.

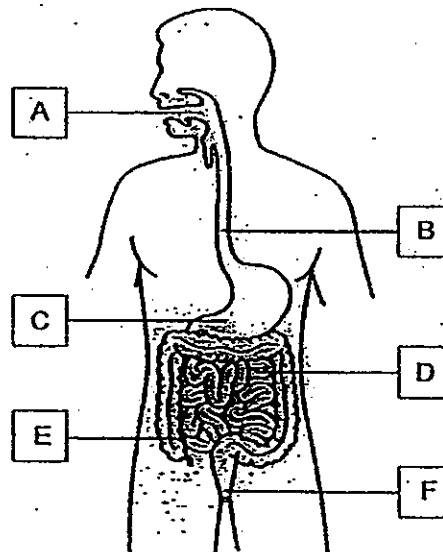

Digestion of food occurs in parts _____

- (1) A, C and D
 (2) B, E and F
 (3) C, D and E
 (4) D, E and F

- 5 Wei Jie wanted to find out if plants respond to sunlight. The diagrams below show how four similar plants were set up in the garden. The plants were given the same amount of water daily.

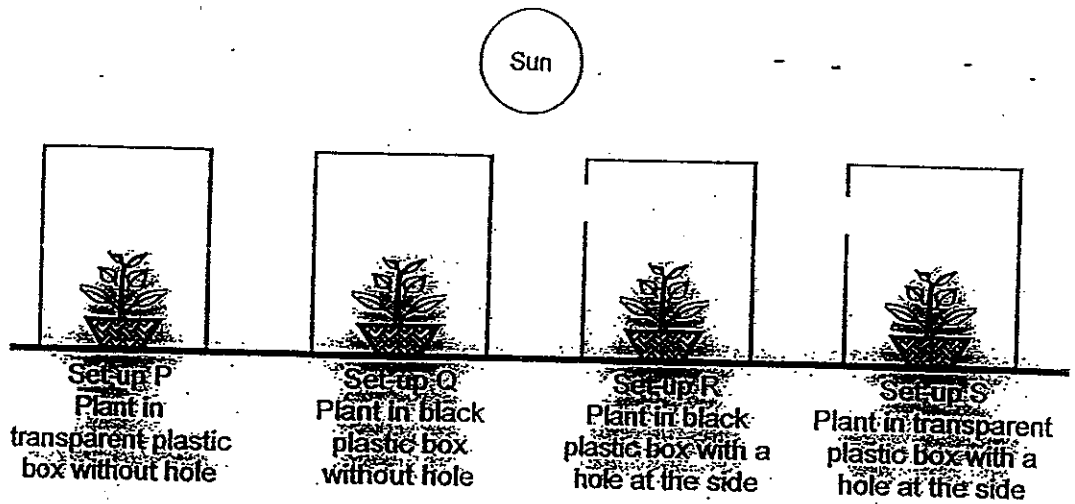

Which two set-ups would be most suitable for his experiment?

- (1) P and R
 - (2) P and S
 - (3) Q and R
 - (4) Q and S
- 6 Zeng Yang removed an outer ring of a stem between two positions, X and Y, of a healthy plant as shown below. The food-carrying tubes between X and Y were removed while the water-carrying tubes remained intact.

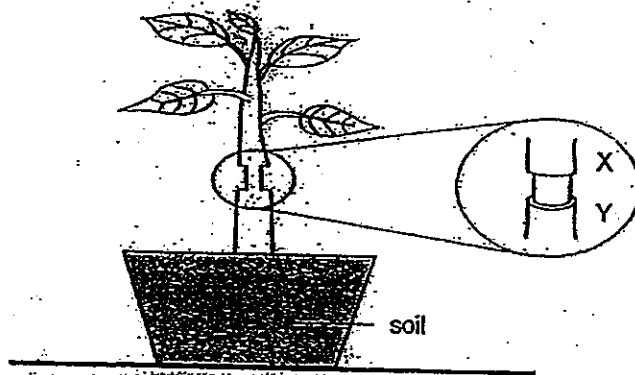

Which one of the following diagrams correctly shows how the stem would probably look like after a few days?

- (1)
- (2)
- (3)
- (4)

- 7 Jon set up the experiment as shown below and left it to stand in an open field from 2pm to 10pm.

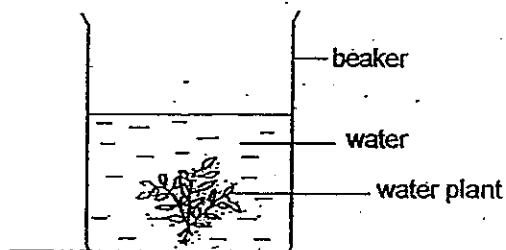

After a while, he noticed that air bubbles began to form on the leaves. Which one of the graphs below most likely shows the rate at which the number of air bubbles were formed between 2pm and 10pm?

(1)

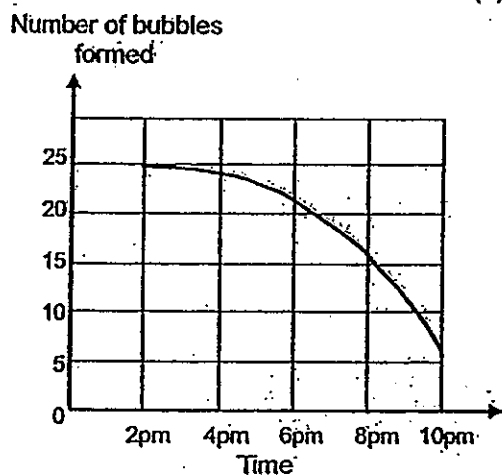

(2)

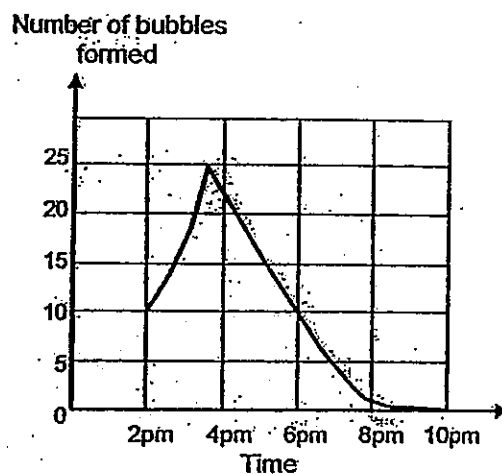

(3)

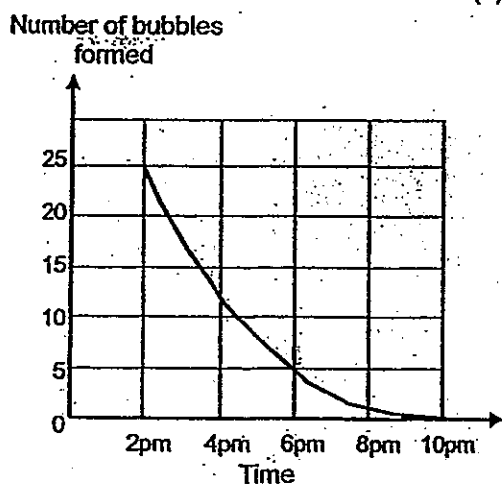

(4)

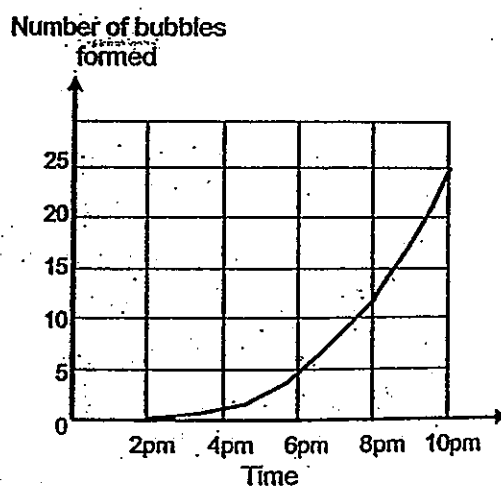

8. Xavier tied a transparent plastic bag with Solution A to a leaf of a healthy plant as shown below. Solution A changes colour according to the amount of carbon dioxide it is exposed to as shown in the key provided.

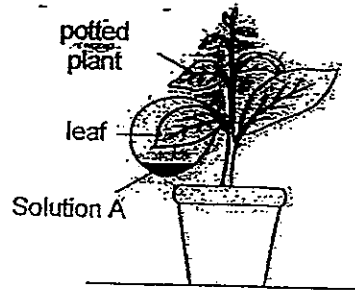

Key	
Colour of Solution A	Amount of carbon dioxide
Purple	Less than surrounding air
Red	Same as surrounding air
Yellow	More than surrounding air

What colour will Solution A be at noon and midnight?

	At noon	At midnight
(1)	Purple	Yellow
(2)	Purple	Red
(3)	Red	Purple
(4)	Red	Yellow

9. The table below shows the characteristics of five plants; A, B, C, D and E.

Characteristics	Plant A	Plant B	Plant C	Plant D	Plant E
Colour of flowers	Red	Pink	Yellow	Pink	Yellow
Vein pattern of leaves	Network	Network	Parallel	Network	Parallel
Leaf edge	Entire	Toothed	Entire	Entire	Entire
Presence of fruit	None	Yes	None	Yes	None

Ahmad classified the plants into two groups as shown below:

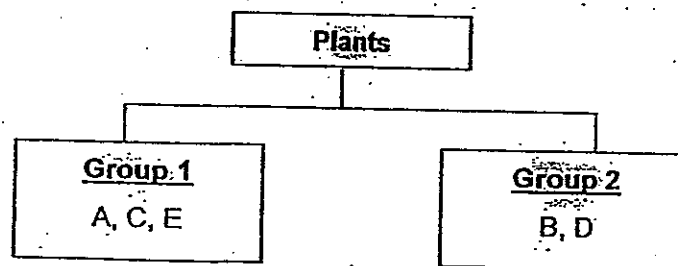

Ahmad had classified the plants according to the _____.

- (1) leaf edge
- (2) presence of fruit
- (3) colour of their flowers
- (4) vein pattern of their leaves

- 10 Look at the pictures of the three organisms shown below.



The organisms shown above are similar in that they _____.

- (1) reproduce by spores
 - (2) do not photosynthesise
 - (3) are found in dark places
 - (4) break down dead organisms into simpler substances
- 11 Evan cycled down a road at night past a lamp post as shown below.

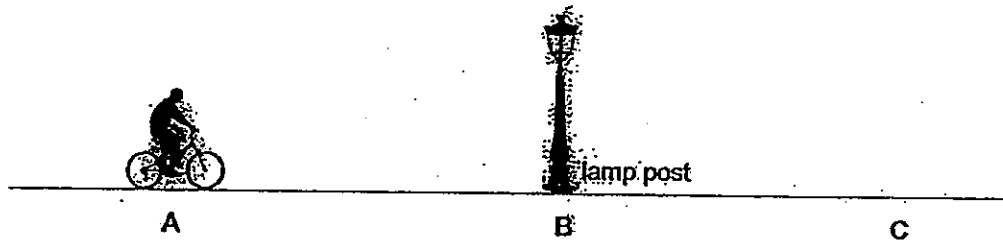

Which one of the following graphs shows correctly the changes in the length of Evan's shadow as he cycles from point B to point C over a period of time?

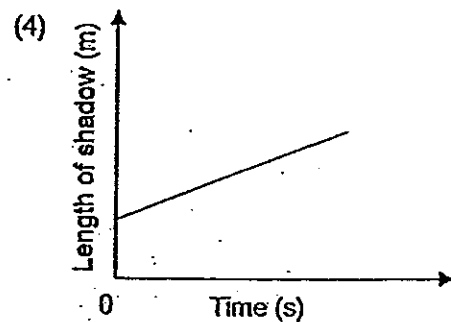
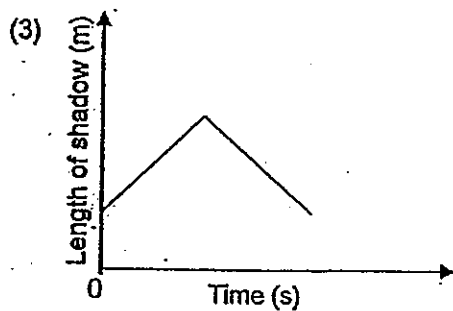
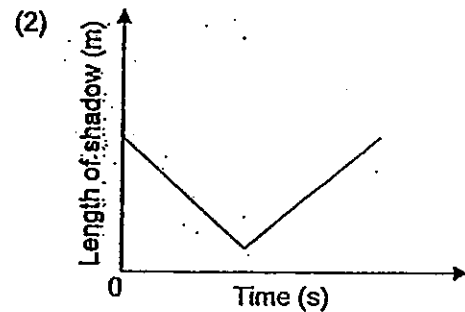
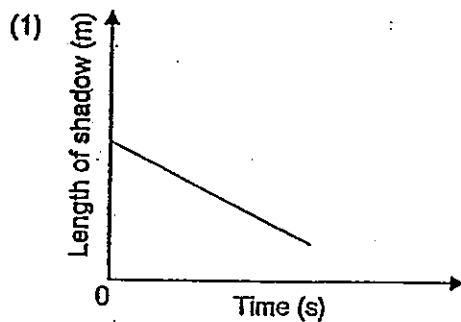

- 12 Three students, Annie, Bala and Colin, used data-loggers to measure the temperature of three different places from 7.00 am to 10.00 am.

Students	Location of data-logger
Annie	In the classroom
Bala	Under a stone bench outside the canteen
Colin	At one end of the outdoor basketball court

The graphs below show the data collected.

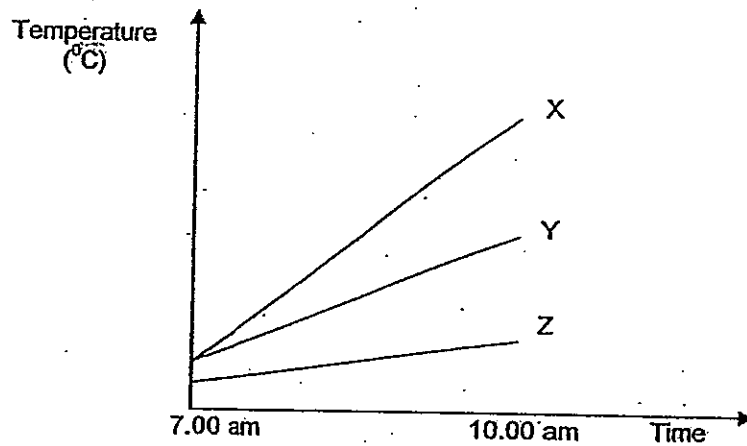

Which of the following is the most probable match between the students' findings and the graphs obtained?

	Annie	Bala	Colin
(1)	X	Y	Z
(2)	Y	X	Z
(3)	Z	X	Y
(4)	Z	Y	X

- 13 Darren set up an experiment as shown below to compare how well four different materials conduct heat. The rods P, Q, R and S were of the same size and temperature at the start. They were placed in a container of crushed ice at the same time on a table in the science laboratory.

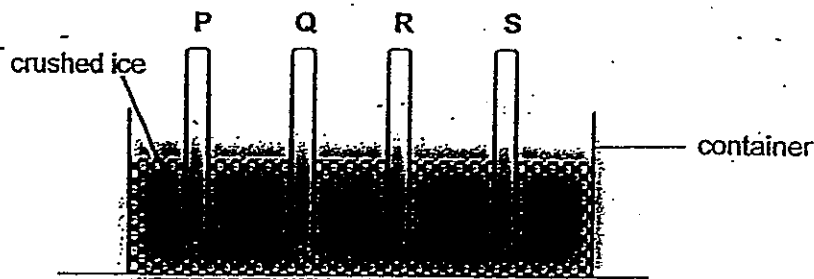

The table below shows the temperature of each rod after five minutes.

Rod	Temperature (°C)
P	24
Q	9
R	15
S	20

Based on the results of his experiment, Darren can conclude that rod _____.

- (1) Q is not a metal
 - (2) P is the best conductor of heat
 - (3) Q is a better conductor of heat than R.
 - (4) R is a poorer conductor of heat than S
- 14 Melvin set up an experiment as shown below.

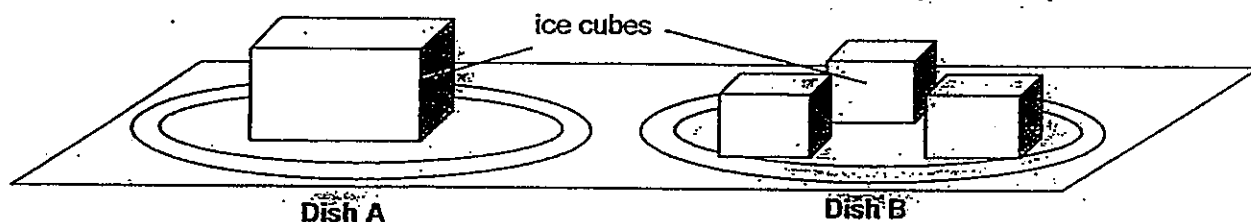

He used the same amount of water to make the ice on the two dishes of ice cubes. The two plates of ice cubes were placed on a table in the Science Room. On which dish, A or B, would Melvin observe the ice cube(s) melt completely first and why?

	Dish	Explanation
(1)	A	The ice has a greater volume.
(2)	A	The ice has a greater exposed surface area.
(3)	B	The ice cubes have a greater exposed surface area.
(4)	B	The total volume of the ice cubes is greater.

- 15 Three identical barrels K, L and M were released from the top of the ramp one after the other. The diagram below shows the three positions of the barrels as they rolled down the ramp.

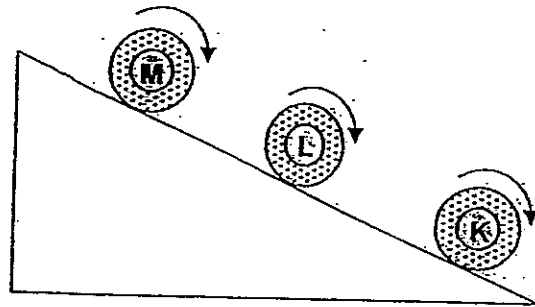

Based on the above diagram, which of the following statements are true?

- A Barrel K has less kinetic energy than barrel M.
- B Barrel L has more kinetic energy than barrel M.
- C Barrel L has less gravitational potential energy than barrel K.
- D Barrel M has more gravitational potential energy than barrel L.

- (1) A and C only
- (2) A and D only
- (3) B and C only
- (4) B and D only

- 16 Joshua balanced two identical plastic bowls, P and Q, as shown below. When the candle was lit, bowl P moved upwards and bowl Q moved downwards. What was the energy conversion that took place that caused this to happen?

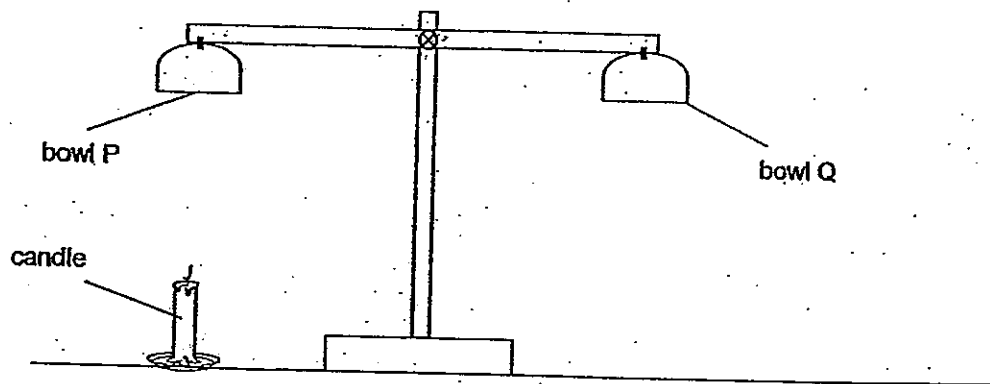

- (1) Potential energy → Heat energy → Kinetic energy → Kinetic energy
- (2) Kinetic energy → Potential energy → Kinetic energy → Potential energy
- (3) Heat energy → Potential energy → Kinetic energy → Potential energy
- (4) Light energy → Heat energy → Potential energy → Kinetic energy

- 17 Akmal used four identical marbles in the four set-ups shown below. Which two set-ups shown below can be used in an experiment to show that the higher the ramp, the greater potential energy the ball possesses?

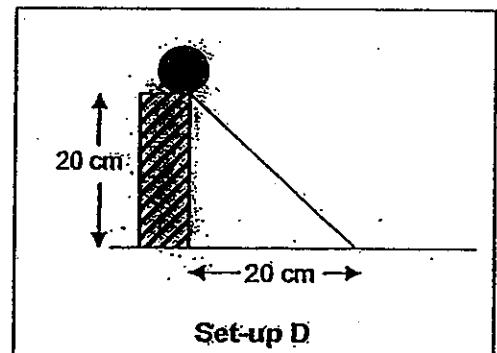
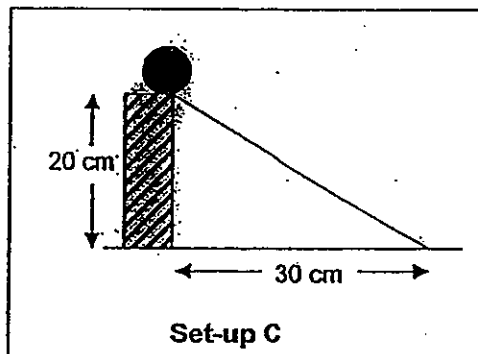
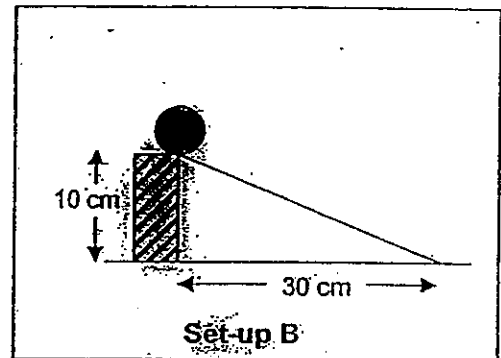
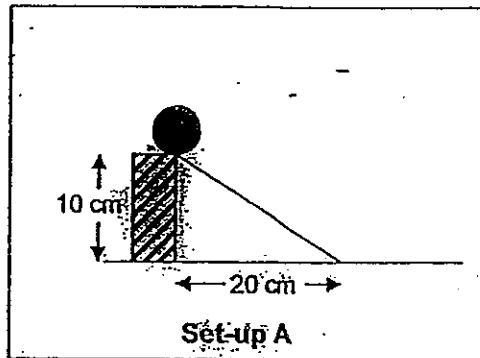

- (1) A and B
 (2) A and D
 (3) B and D
 (4) C and D
- 18 The table below shows the temperatures suitable for three different seeds, K, L and M, to germinate.

Seed	Temperature ($^{\circ}\text{C}$)	
	Lowest	Highest
K	10	25
L	20	43
M	18	39

A farmer wanted to grow a crop in an environment where the temperature varies between 21°C and 40°C . Which seed(s) have the best chance of surviving this environment?

- (1) K only
 (2) L only
 (3) K and M only
 (4) L and M only

- 19 Jamal carried out an experiment using four similar pots of small plants. Different amounts of water were poured into each pot as shown below.

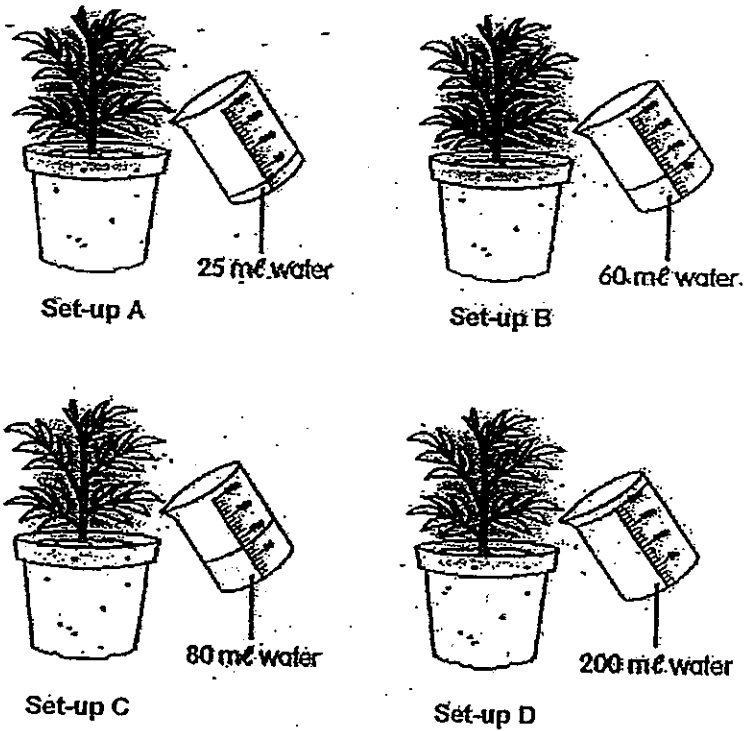

Jamal measured the heights of the plants every day for ten days. His results are recorded in the table below.

Day	Height of plants (cm)			
	Set-up A	Set-up B	Set-up C	Set-up D
3	4	5	6	6
5	5	7	8	7
7	6	10	10	7
10	8	12	12	7

What is the least amount of water needed for the plant to grow to its maximum height?

- (1) 20 ml
- (2) 60 ml
- (3) 80 ml
- (4) 200 ml

- 20 A magnet was hung from point A and it attracted a number of staples on the table.

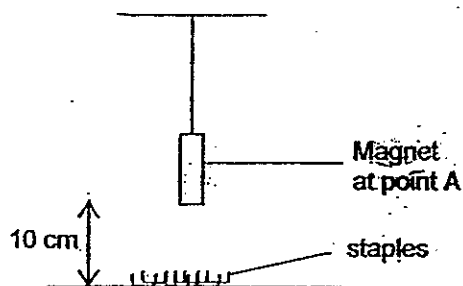

The experiment was repeated by placing the same magnet at points B, C and D and the distances involved are shown in the table below.

Point	Distance of magnet from the staples (cm)
A	10
B	20
C	16
D	12

Based on the table above, which one of the graphs below is most likely correct?

(1)

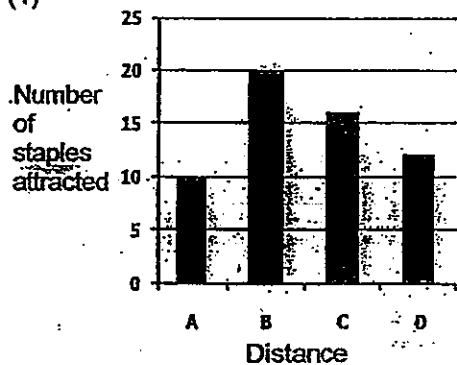

(2)

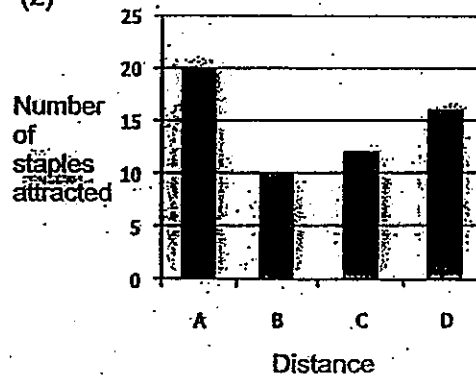

(3)

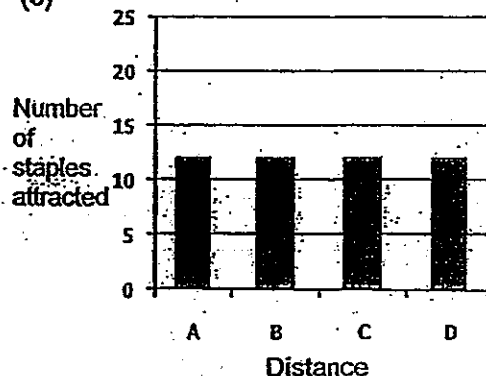

(4)

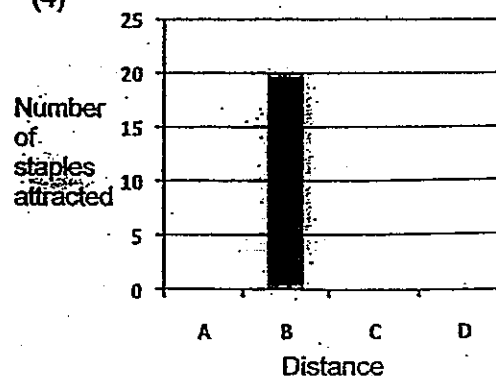

- 21 The graph below shows how the volume of air in a syringe changes as the plunger is pushed.

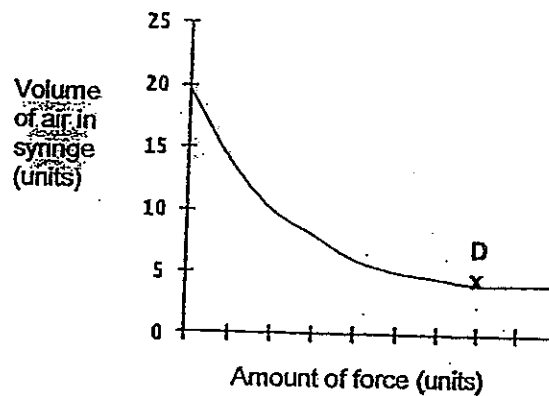
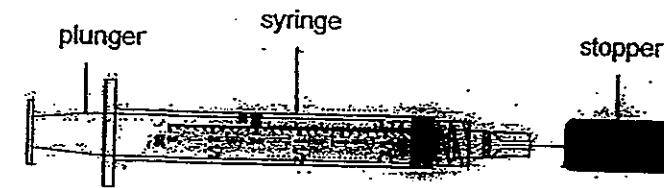

Which one of the following information can be obtained from the graph?

- (1) Air has no definite shape.
 - (2) There is no more air from point D onwards.
 - (3) Force causes the volume of air to decrease.
 - (4) Both the volume of air in the syringe and force increase.
- 22 100 ml of water dripped slowly from container A onto a glass slope as shown below.

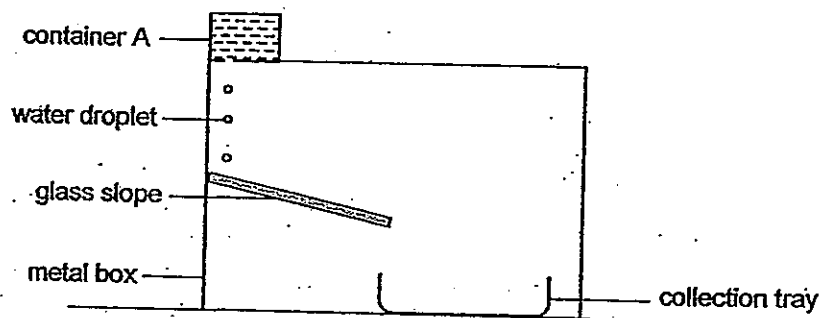

Which one of the following can quickly increase the amount of water vapour in the box?

- (1) Make the glass slope horizontal.
- (2) Lay some cotton on the glass slope.
- (3) Put some ice-cubes on top of the metal box.
- (4) Wrap a warm towel around the collection tray.

- 23 The diagram below shows the lifecycle of the mealworm beetle.

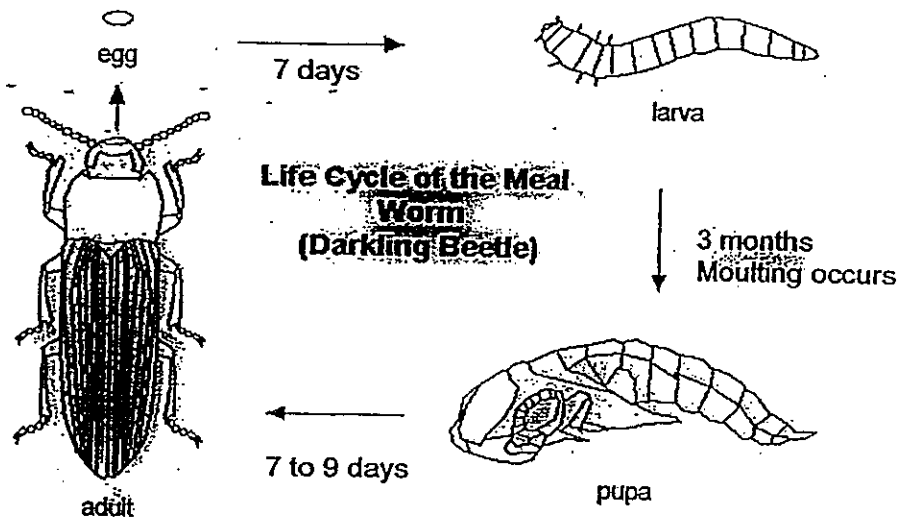

Based on the diagram above, which one of the statements below is false of the mealworm beetle?

- (1) It has four stages in its life cycle.
 - (2) It moults during the larva and pupa stage.
 - (3) It develops into an adult beetle after the pupa stage.
 - (4) It takes between 7 to 9 days for the pupa to change into an adult.
- 24 Look at the diagram below carefully.

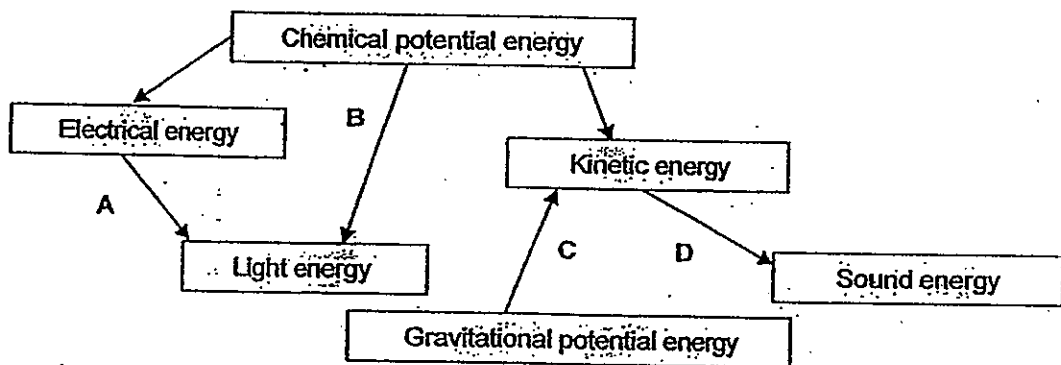

What activities do the letters A, B, C and D represent?

	A	B	C	D
(1)	Turning on a light bulb	Burning of wood	Apple falling from a tree	Clapping hands
(2)	Burning wood	Playing computer games	Throwing a Frisbee	Jogging
(3)	Burning papers	Lighting a candle	Bird flying	Singing
(4)	Striking a match	Fireworks display	Clapping hands	Telephone ringing

- 25 The graph below shows how the length of two springs M and N are affected by the weight hung on the springs. The distance between line M and line N is constant throughout.

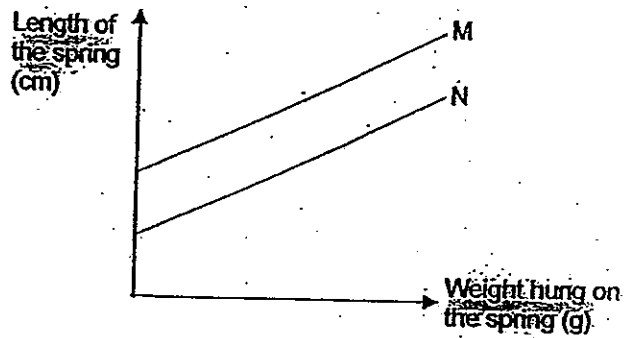

Which of the statements are true?

- A Both springs are of the same original length.
 B The extension of both springs is the same for the same weight hung.
 C The original length of spring M is greater than the original length of spring N.
 D The elastic spring force on Spring M is greater than that on spring N when the same weight is hung.
- (1) A and B only
 (2) B and C only
 (3) B and D only
 (4) C and D only

- 26 The diagram below shows the cross section of a pond.

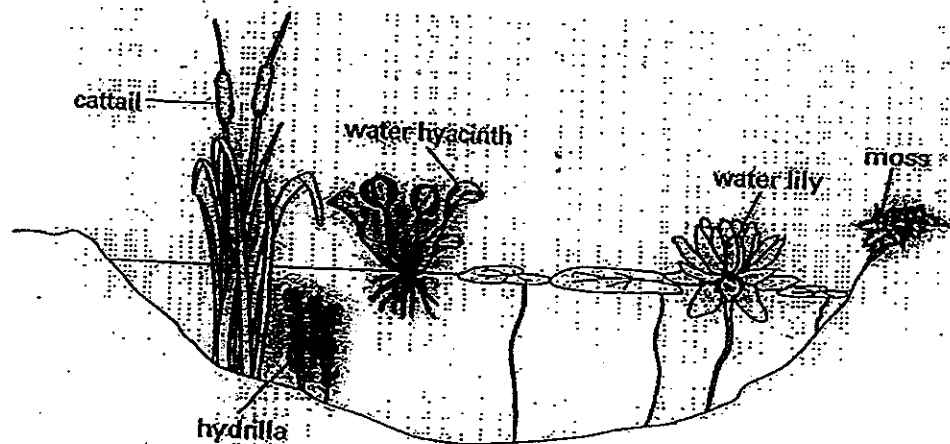

The population size of hydrilla decreases due to the increase in population size of one of the other water plants. Which one of the other water plants below would not cause a decrease in the population size of the hydrilla?

- (1) moss
 (2) cattail
 (3) water lily
 (4) water hyacinth

- 27 The picture below shows a forest being cleared.



What are the likely consequences of clearing large areas of forests?

- A An important source of food is lost.
- B Air quality improves due to lesser trees.
- C Soil becomes easily eroded by wind and rain.
- D Animals are affected as their homes are destroyed.

- (1) A, B and C only
- (2) A, B and D only
- (3) A, C and D only
- (4) B, C and D only

- 28 Joshua bought three different kinds of fish, P, Q and R and put them into two different tanks, X and Y. He put an equal number of fish P and Q into tank X, and equal number of fish P and R into tank Y. He also put in the same number of identical water plants into each of the two tanks. He recorded the number of fish in each tank daily. The graphs below show the results over a week.

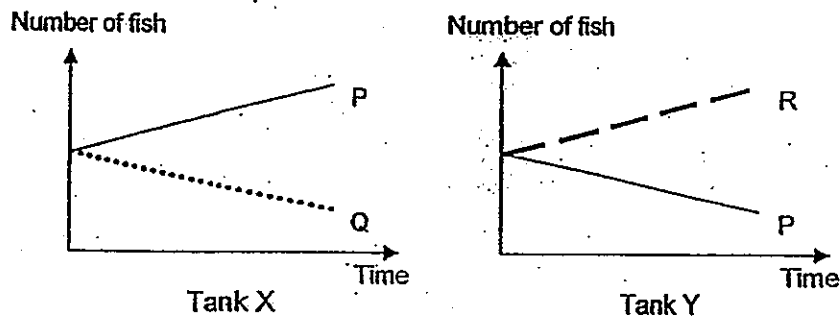

Based on the above graphs, which of the following food chains best shows the relationship between the plant and the three kinds of fish?

- (1) Plant \rightarrow P \rightarrow Q \rightarrow R
- (2) Plant \rightarrow Q \rightarrow P \rightarrow R
- (3) Plant \rightarrow R \rightarrow P \rightarrow Q
- (4) Plant \rightarrow Q \rightarrow R \rightarrow P



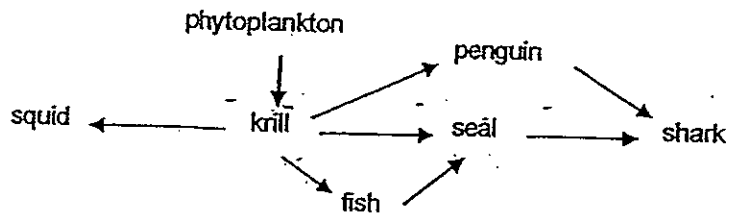

29 The diagram below shows a food web.



Which of the organisms below are preys as well as predators?

- (1) Shark and fish
- (2) Seal and shark
- (3) Fish and penguin
- (4) Phytoplankton and seal

30 Birds have different types of beaks to help them feed in the environment. Study the table below carefully.

Type of beak	Example of bird	Function of beak
A		To feed on fish
B		To crush hard seeds and nuts
C		To tear the meat of its prey
D		To peck the ground for insects

Which beaks have been correctly matched to their functions?

- (1) A and B only
- (2) A and D only
- (3) B and C only
- (4) C and D only



Index No.

--	--	--	--	--	--



Anglo-Chinese School (Junior)
Anglo-Chinese School (Primary)

COMBINED PRELIMINARY EXAMINATION 2012

**SCIENCE
BOOKLET B**

Monday

27th August 2012

1 hour 45 minutes

Name : _____ ()

Class : P6. _____

INSTRUCTIONS TO PUPILS

DO NOT TURN OVER THE PAGES UNTIL YOU ARE TOLD TO DO SO

Follow all instructions carefully.

There are 16 questions in this booklet.

Answer ALL questions.

INFORMATION FOR PUPILS

The number of marks is given in brackets [] at the end of each question or part question.

The total marks for this booklet is 40.

The total time for Booklets A and B is 1 hour 45 minutes.

This question paper consists of 16 printed pages. (Inclusive of cover page)

BOOKLET A	/ 60
BOOKLET B	/ 40
TOTAL	/ 100
Parent's signature/ Date:	

For questions 31 to 44, write your answers in this booklet. The number of marks available is shown in brackets [] at the end of each question or part question. (40 marks)

- 31 Darshan learnt that yeast can reproduce when mixed in sugar solution. As a result, carbon dioxide is also released. He set up the experiment shown below with equal amounts of yeast and equal volumes of sugar solution in five similar test-tubes. The test-tubes were placed in five beakers filled with water of different temperatures (0°C , 25°C , 50°C , 75°C and 100°C).

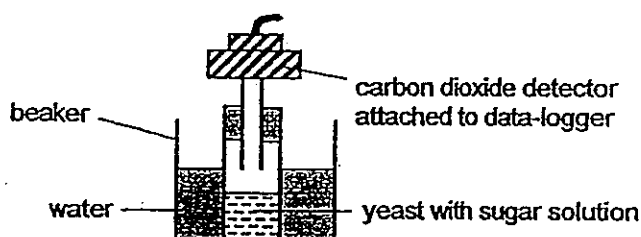

The graph below shows the results obtained at the end of Darshan's experiment.

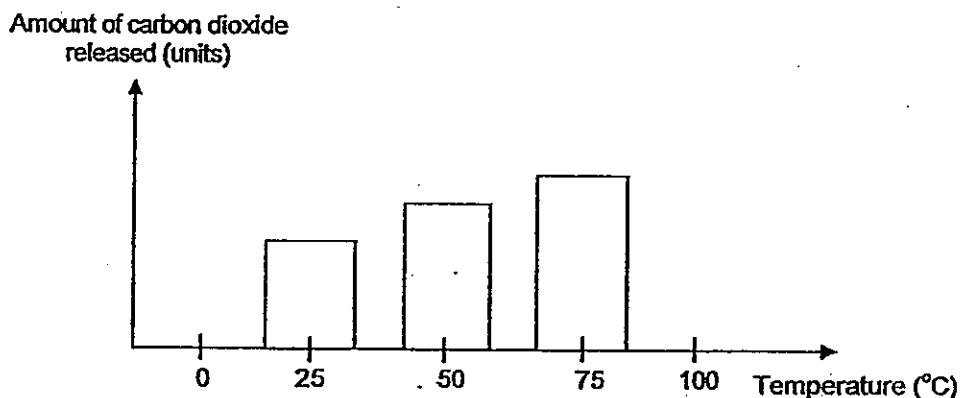

- (a) Based on ~~the~~ Darshan's experiment, what was he trying to find out? [1]
- _____
- _____
- (b) Using Darshan's experimental results, which temperature(s) was/were least suitable for yeast to reproduce? [1]
- _____

(Go on to the next page)

- 32 Oliver set up the experiment as shown below to test the conditions needed for decomposition. Liquid Y was used to test the presence of carbon dioxide. It would turn chalky when it is exposed to carbon dioxide. He kept the set-ups undisturbed for one week in the Science laboratory.

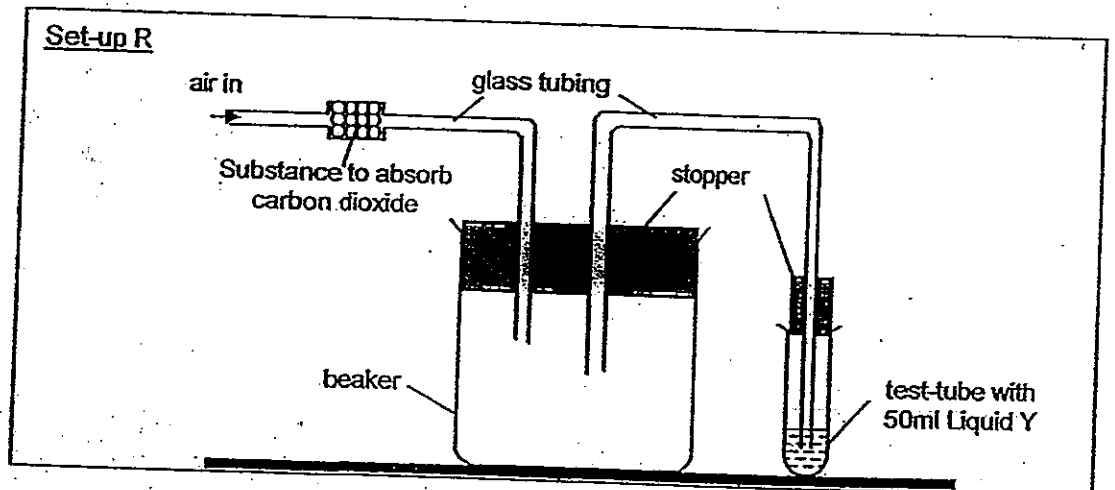
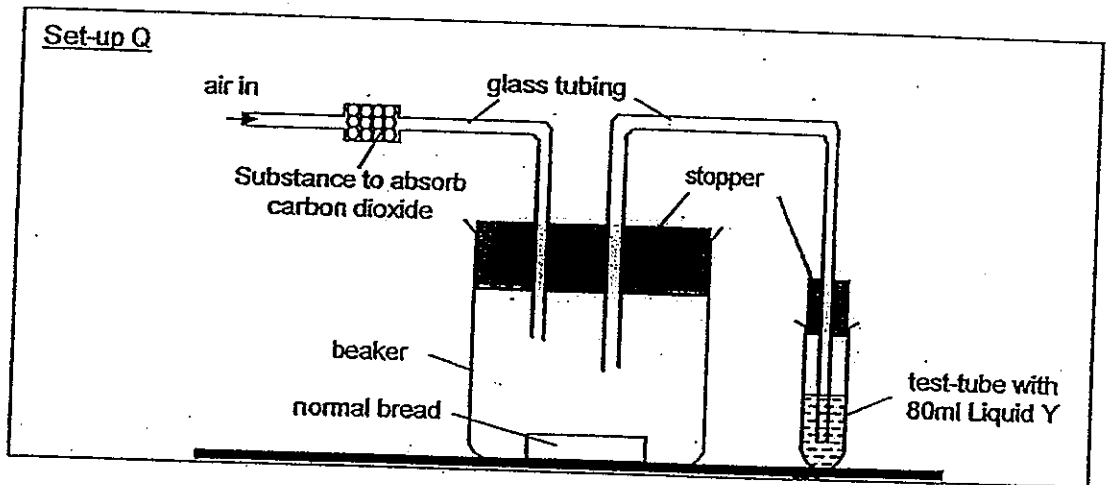
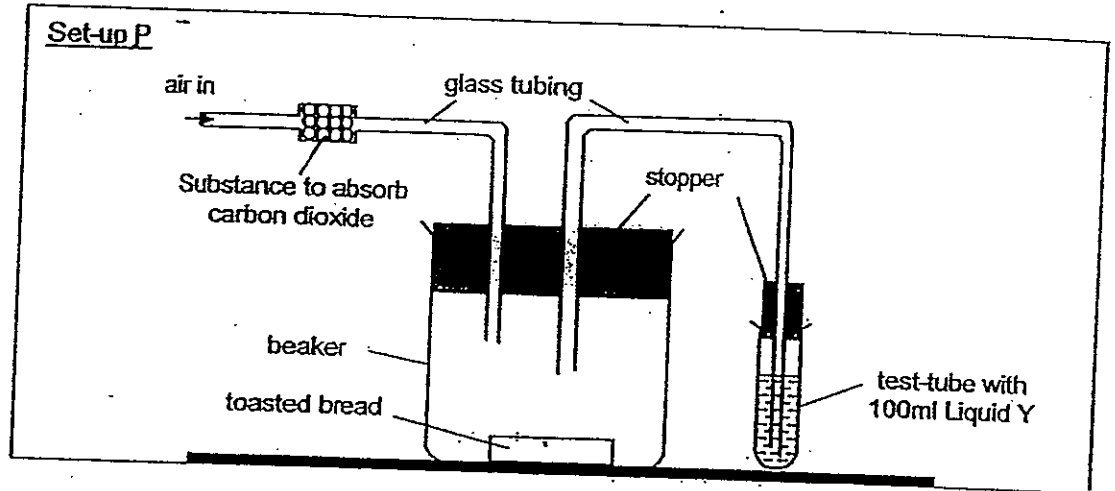

(Go on to the next page)

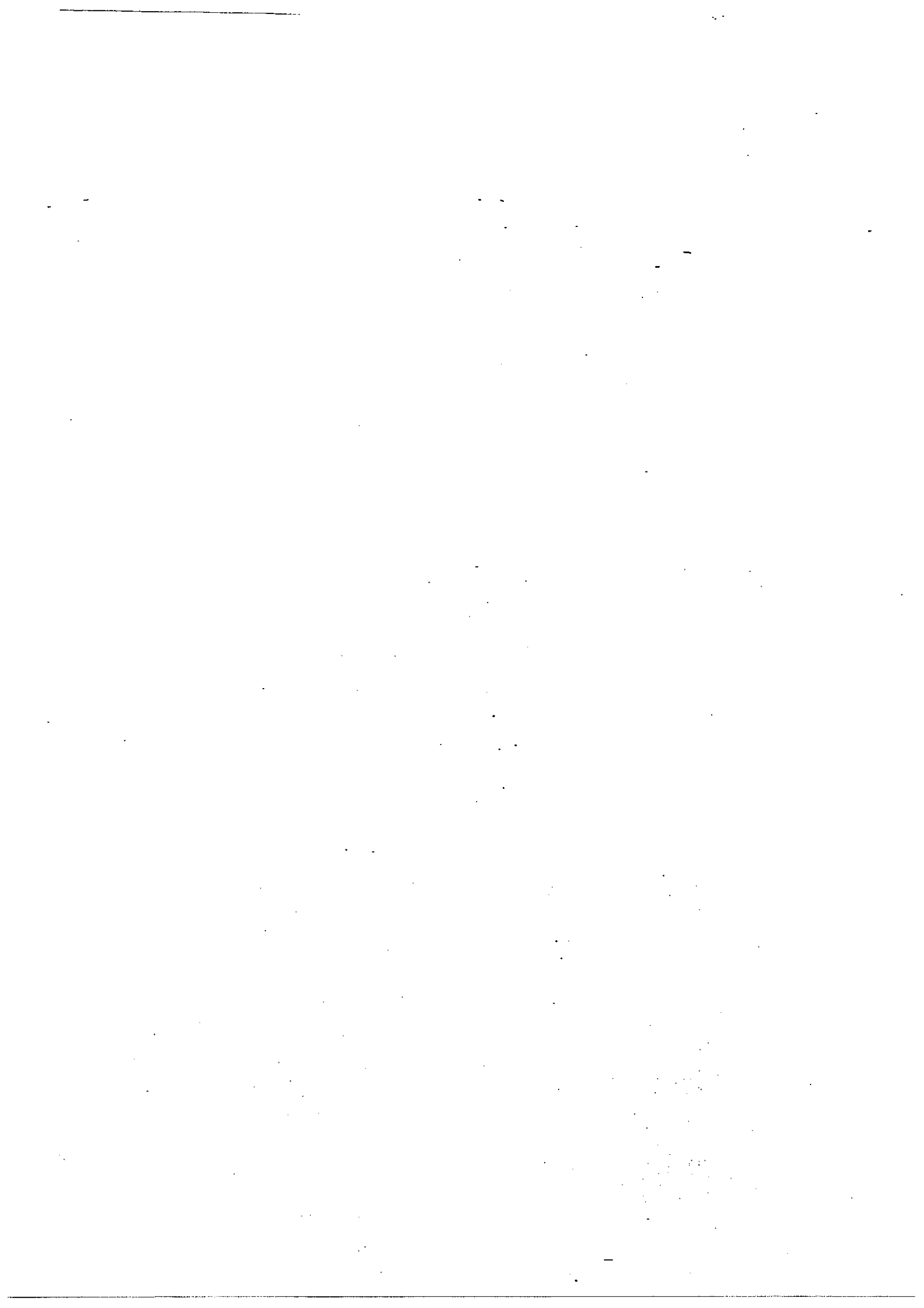

(a) Oliver was told that his experiment was unfair. Suggest what he could do to improve his set-up. [1]

(b) Oliver sprinkled some water onto the bread in Set-up Q. What would he observe in the test tube of Liquid Y after another week? Explain your answer. [1]

(c) How does the presence of the substance that absorbs carbon dioxide make the experiment fair? [1]

(Go on to the next page)

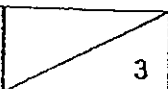
Score	
	3

33 Benjamin kept a pot of healthy Coleus plant in a dark cupboard for twenty-four hours. He then placed it in his garden for another twenty-four hours. He plucked similar-sized leaves from the plant to test for starch at regular intervals throughout the forty-eight hours of the investigation. The results of his observation are shown in the graph below.

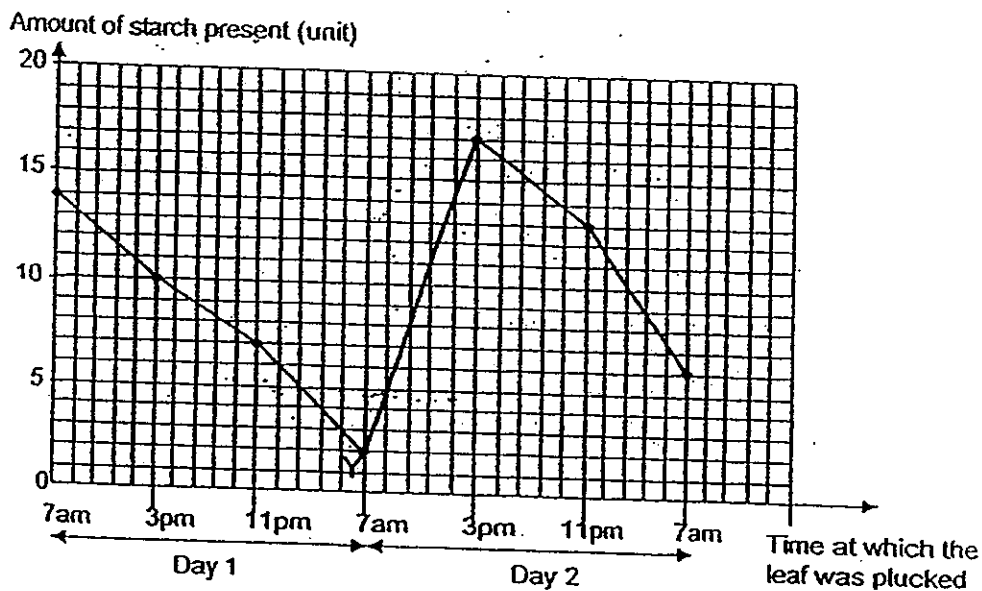

(a) Fill in the blanks in the table below to show the reading for point Y. [1]

Time at which the leaf was plucked	7am	3pm	11pm		3pm	11pm	7am
Amount of starch present (units)	14	10	7		17	13	6

(b) Suggest why the amount of starch in the leaves decreased in the first 24 hours. [1]

(c) The diagram below shows how the Coleus plant looks like.

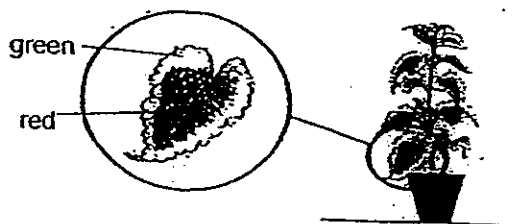

Why could the Coleus plant photosynthesise well although most parts of its leaves are red? [1]

34 Marcus learnt that different body systems work together to enable certain life processes to take place. He drew the diagram below to represent one of the human body systems.

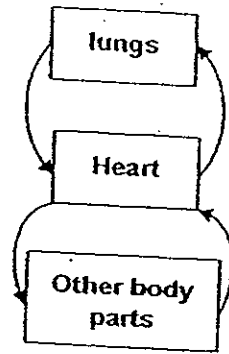

(a) Name two other human body systems which work closely with the above system to enable respiration to take place. [1]

Marcus wanted to find out which of his twin brothers have a greater lung capacity. He prepared two identical set-ups as shown below. He invited Sebastian and Nicholas who were skipping and reading respectively to take part in his experiment. The two brothers stopped whatever they were doing, took a deep breath each and blew into the bent straw as shown below. He observed that as his brothers blew into the straw, bubbles of air pushed the water out of the bottle.

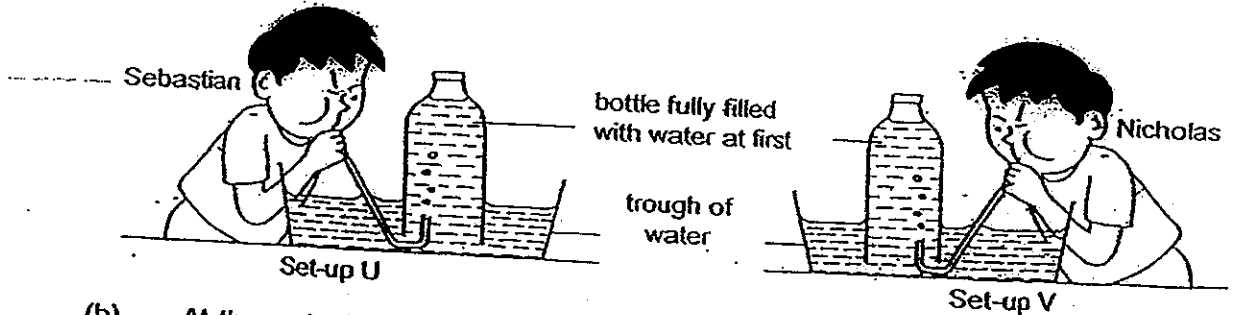

(b) At the end of the experiment, Marcus concluded that Nicholas had a greater lung capacity than Sebastian. What did he measure to enable him to arrive at this conclusion? [1]

(c) Nicholas commented that Marcus did not conduct a fair experiment. As such, the conclusion was inaccurate. Is Nicholas correct? Explain your answer. [1]

Score	3
-------	---

35 The flow chart below shows the characteristics of 5 different animals represented by the letters P, Q, R, S and T. Study it carefully and answer the following questions.

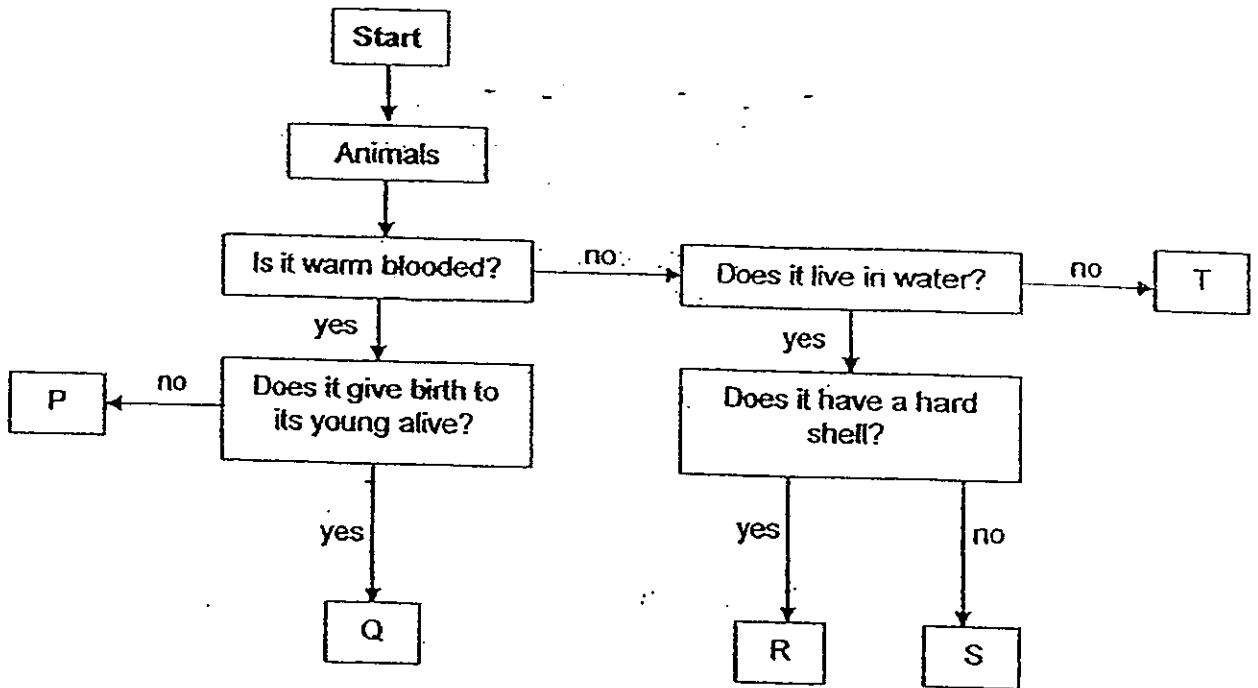

(a) State two common characteristics between animal R and S. [1]

(b) State one difference between animals Q and R. [1]

(c) Which letter would represent the ladybird? [1]

36 Ryan set up an experiment as shown below in the Science Room.

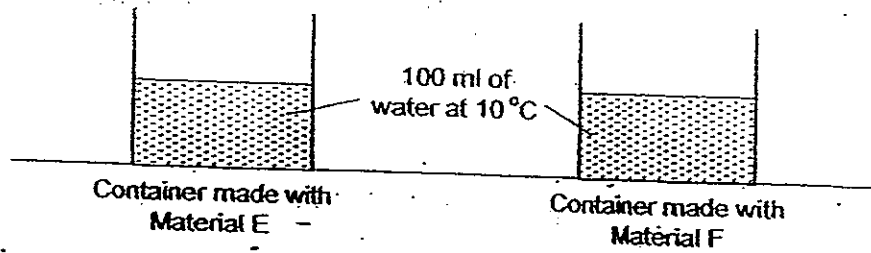

The containers were of the same shape and capacity. They were filled with 100ml of water at 10°C at the same time. The temperature of the water was taken every five minutes and the readings were recorded in the table below.

	Temperature of the water after...			
	5 min	10 min	15 min	20 min
Material E	15°C	21°C	26°C	29°C
Material F	12°C	14°C	17°C	20°C

(a) Which material is more suitable for making a frying pan? Explain your answer. [1]

(b) Another experiment was set up at the same location using the same containers. This time, they were filled with 100 ml of water at 100°C at the same time.

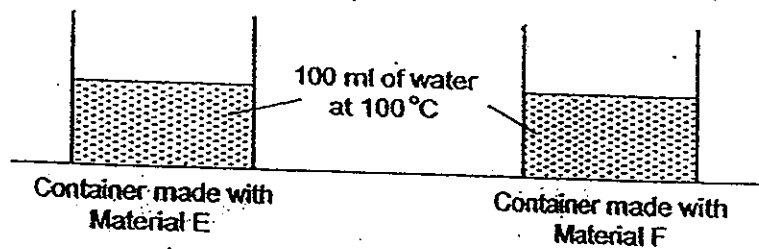

In the space provided below, draw two line graphs to show the changes in temperature for both containers after 20 minutes. Label your graphs and axes. [2]

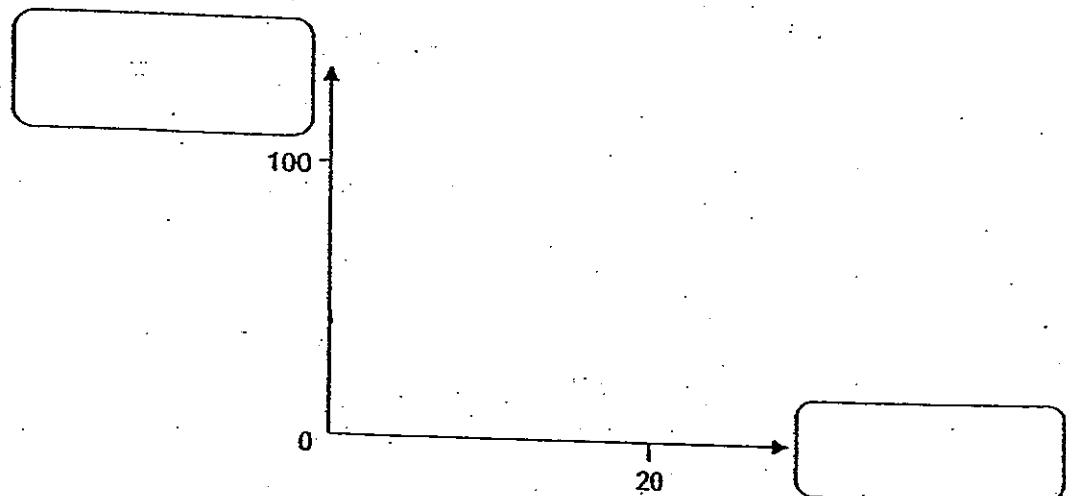

(Go on to the next page)

Score	3
-------	---

37 Dylan made a toy as shown below.

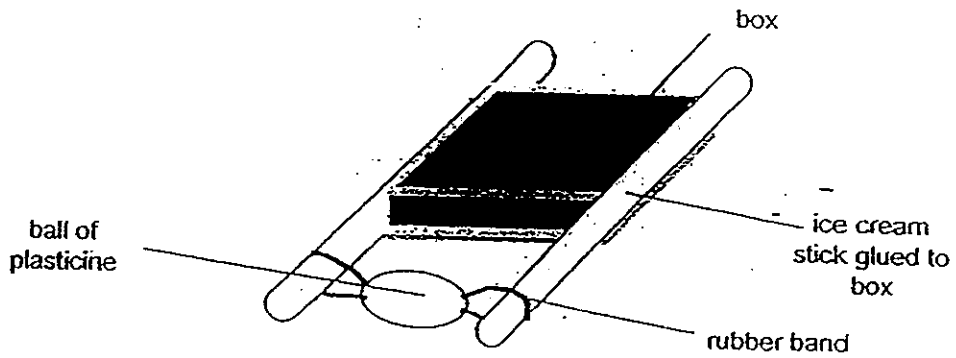

He turned the ball of plasticine 10 times. When he placed the toy on the table, the toy moved forward.

(a) Explain why the toy was able to move on its own when it was placed on the table. [1]

(b) Without changing any part or using additional force, what can Dylan do to make the toy move a further distance? [1]

Dylan made a second toy similar to the first, except that a hole was cut out from the middle of the box.

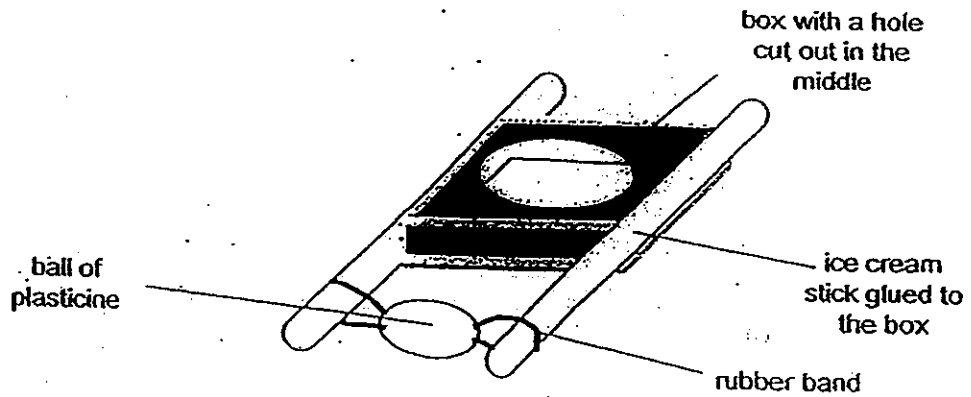

(c) When Dylan turned the ball of plasticine ten times, the toy moved a further distance when it was placed on the table. Explain why the second toy moved a further distance than the first toy. [1]

(Go on to the next page)

Score	3
-------	---

38 The diagrams below show a ball of crushed paper and a flat sheet of paper, both made from paper of the same type, size and weight. Both pieces of paper are released from a height of 5 meters at the same time.

Position at the start



5 metres

Position at the end



ball of crushed paper

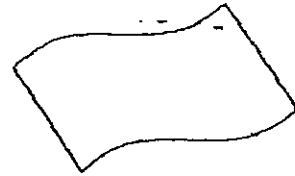

5 metres

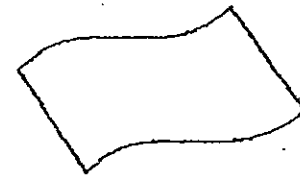

flat sheet of paper

(a) State two types of forces that are acting on the paper when they are falling to the ground. [1]

(b) Which paper will reach the ground first? Explain your answer. [1]

Score	2
-------	---

- 39 A farmer discovered that his fruit trees were infested by aphids. He wanted to find out which other organisms can help to remove the aphids so as not to destroy the trees. However, he was unsure which organism was most effective so he tested four types of organisms, A, B, C and D.

He put 20 organisms and 150 aphids into each similar sized enclosed tank with air holes at the start of the experiment. There was sufficient water and air for the organisms and the aphids and there was enough food for the aphids throughout the experiment. The table below shows the results of the experiment after ten days.

Tank with	Number of organisms at the start of the experiment	Number of organisms after ten days	Number of aphids at the start of the experiment	Number of aphids after ten days
Organism A	20	13	150	98
Organism B	20	24	150	47
Organism C	20	35	150	18
Organism D	20	20	150	82

- (a) Why was it necessary for the farmer to start the experiment with the same number of organisms and aphids in each cage? [1]

- (b) Which organism would be the best to remove the aphids in his fruit plantation? Explain your answer. [1]

(Go on to the next page)

40 Study the food chain shown below.

GRASS → GRASSHOPPER → FROG → SNAKE

A sudden decrease in the population size of one organism in the food chain above will affect the other organisms in the food chain.

(a) Identify two changes that are likely to happen to the organisms in this food chain if most of the frogs in this habitat contracted a disease and died. [1]

Change 1: _____

Change 2: _____

(b) Explain why each change is likely to occur. [1]

Explanation for change 1: _____

Explanation for change 2: _____

(c) Two other food chains exist in the same habitat as shown below. Construct a food web using all three food chains in the box below.

GRASS → GRASSHOPPER → LIZARD → CROW → SNAKE

GRASS → GRASSHOPPER → SPIDER → CROW → SNAKE

(Go on to the next page)

Score	3
-------	---

41 Study the diagrams below which show animal X and a jacket.

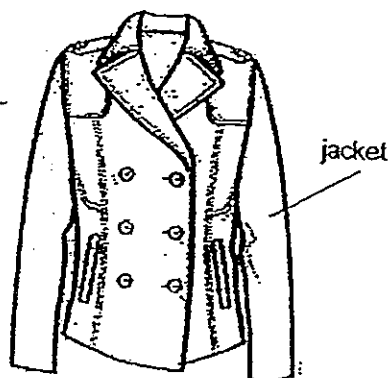
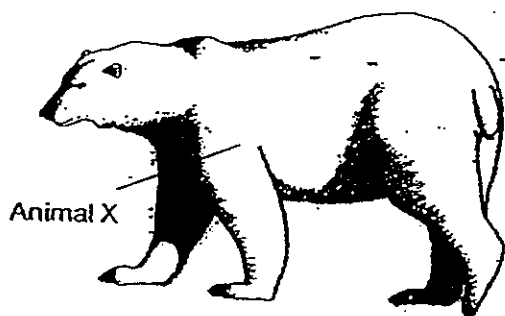

(a) People often wear a jacket when the temperature is low. How do the thick fur of animal X and a jacket that someone wears keep them warm in a cold environment? [1]

(b) Animal X's habitat is cold and icy all-year round. It is also surrounded by snow. List two other structural adaptations of animal X that enable it to survive in its habitat other than its thick fur. Explain how each adaptation helps animal X. [2]

(i) _____

(ii) _____

Score	3
-------	---

- 42 Farmer Ken decides to use pesticide on his vegetable farm, which is surrounded by rivers. The graph below shows the population of earthworms and locusts in his farm over the period of time when the pesticide was used.

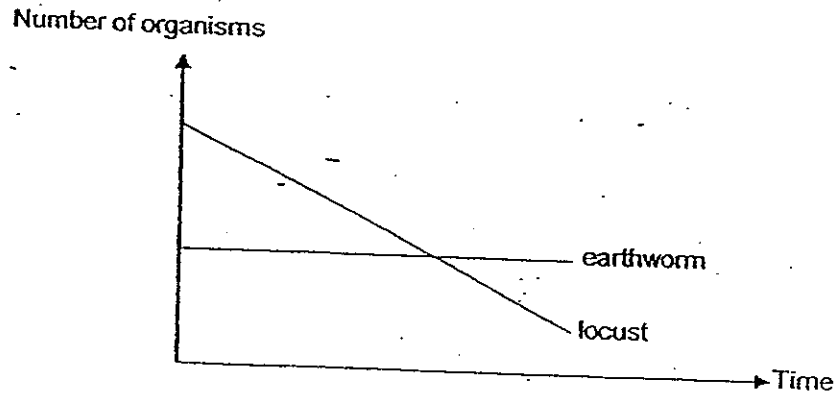

- (a) Using the information from the graph above, what can be concluded about the effect of pesticide on the organisms? [1]

- (b) Explain how the use of pesticide negatively impacts:

(i) the consumers of the vegetables from the farm. [1]

(ii) the rivers. [1]

(Go on to the next page)

Score	3
-------	---

43 The table below shows the characteristics of three different plants A, B and C.

Plant	Does it have flowers?	Can the flower develop into a fruit?	Length of petals (cm)
A	Yes	Yes	8
B	Yes	No	1.5
C	Yes	Yes	6.2

(a) The flower of plant B cannot develop into a fruit. Give a possible reason. [1]

(b) Which plant can best attract pollinators? Explain why. [1]

Study the flowers of plants P and Q as shown in the diagram below.

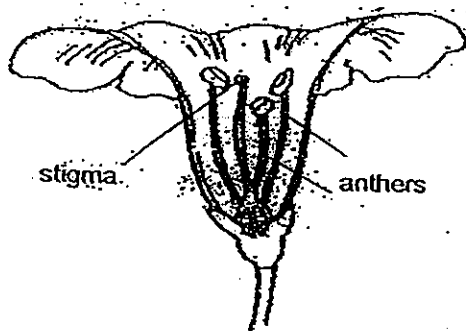

Flower of plant P.

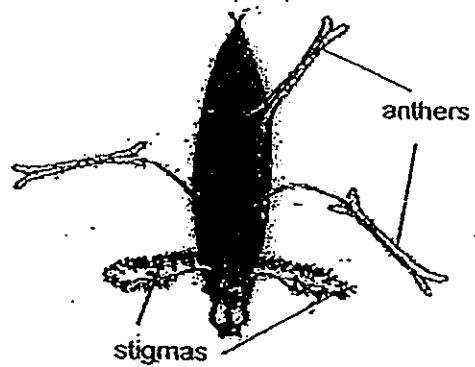

Flower of plant Q.

(c) Based on the diagrams above, give two reasons why Flower Q is more likely to be pollinated by wind. [2]

Reason 1: _____

Reason 2: _____

(Go on to the next page)

Score	4
-------	---

44 Ali wanted to find out which of his two magnets, K or L, is the stronger magnet. He has a smaller round magnet and a measuring tape to help him find out the answer to his question.

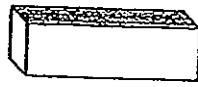

magnet K

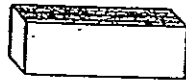

magnet L



round magnet



measuring tape

(a) List the steps that Ali should take to carry out his experiment. [2]

(b) How can Ali conclude which magnet, K or L, is stronger? [1]

Score	3
-------	---

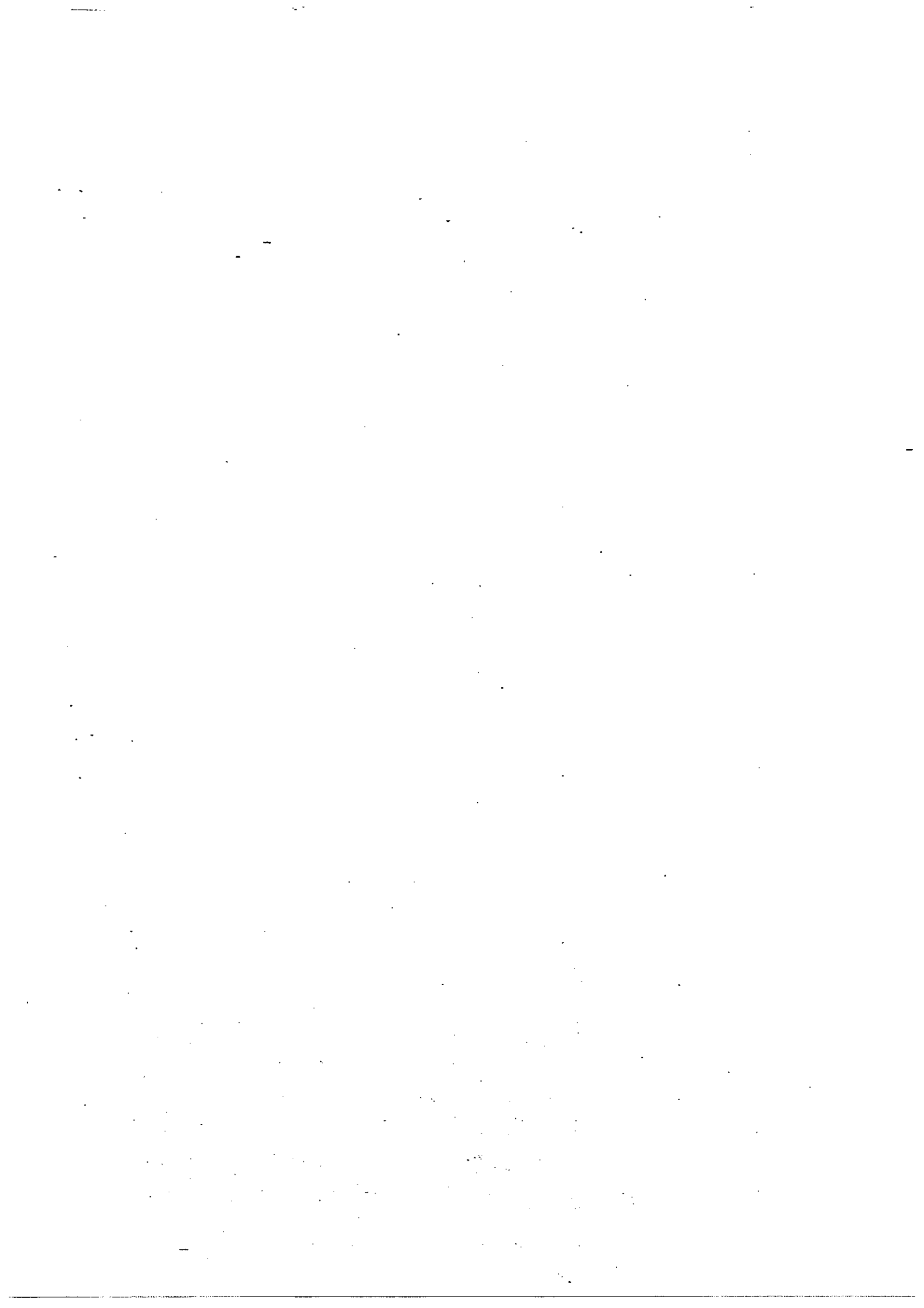

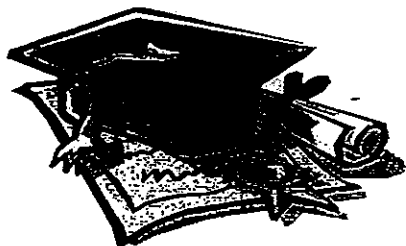

ANSWER SHEET

EXAM PAPER 2012

SCHOOL : ACS
SUBJECT : PRIMARY 6 SCIENCE

TERM : SA2

Q1	Q2	Q3	Q4	Q5	Q6	Q7	Q8	Q9	Q10	Q11	Q12	Q13	Q14	Q15	Q16	Q17
1	4	4	1	3	4	3	1	2	1	4	4	3	3	4	1	2

Q18	Q19	Q20	Q21	Q22	Q23	Q24	Q25	Q26	Q27	Q28	Q29	Q30
2	2	2	3	4	2	1	2	1	3	2	3	3

31)a) To find out if the temperature of water in the beakers affects the amount of carbon dioxide released by the yeast during reproduction.
b) 0°C and 100°C.

32)a) He could make the amount of liquid Y to be the same for all the test-tube.
b) It will turn more chalky. As more carbon dioxide was produced.
c) It ensures the result of the experiment is due to the carbon dioxide released by the organisms (during respiration) in the set-ups and not due to those in the air.

33)a) 7am / 2

b) The plant used the food stored in the leaves/plants.
c) As inside the leaf colored red it has a green pigment called chlorophyll which can help them photosynthesis.

34)a) Respiratory system and digestive system.

b) He measured the amount of water in the bottle left to arrive at his conclusion.

c) Yes. The two brothers were not doing the same activity and thus their lung capacity could not be determined.

- 35) a) It is not a Warm-blooded and it lives in water.
 b) Q is a warm blooded while R is not.
 c) The letter is T.

36) a) Material E. As it can better conductor of heat and loses it slowly.

b)

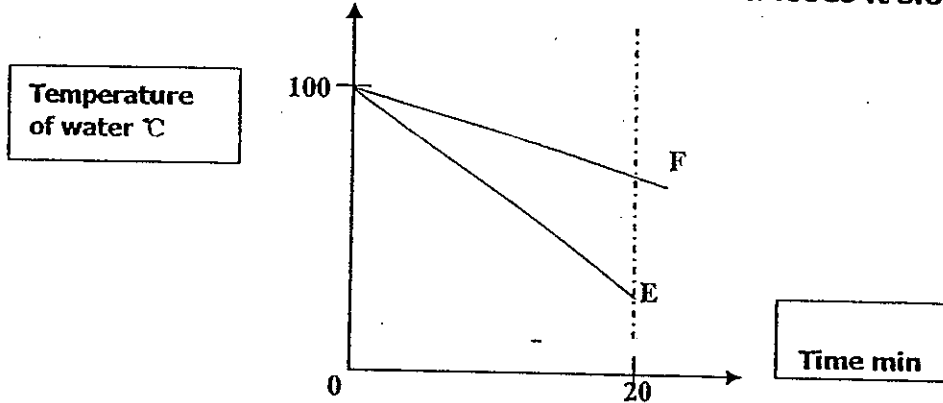

37) a) The twisted rubber band had elastic potential energy which was converted to kinetic energy.

b) Turn the ball of plasticine more time.

c) As the toy is lighter as there is a hole on the box so it will move faster and a further distance.

38) a) Friction and air resistance.

b) The ball of crushed paper has a smaller surface area in contact with the air and thus the upward force friction acting on it is lesser.

39) a) So as to make it a fair test, that any the type of organisms affects the number of aphid left in the tank.

b) Organisms C. The tank has the least number of aphids remaining.

40) a) 1) The population of grasshoppers increase.

2) The snake will decrease.

b) 1) The population of grasshoppers will increase as there is no predators to eat them which is the frogs.

2) The snakes will decrease as they don't have their food which is the frogs.

c)

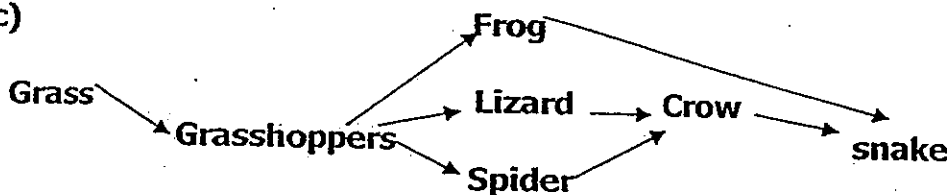

41)a)Both the jacket and thick fur of animal X traps air which is a poor conductor of heat.

- b)i)The white fur helps animal X to camouflage itself from predators.
- ii)It has a layer of fat/blubber to keep itself warm.

42)a)The pesticide made the population of locust decrease while the earthworm remained the same.

- b)i)It will get sick and may die because of the pesticide that is sprayed on the vegetables.
- ii)Will kill aquatic animals and those who drink it.

43)a)It is a make flower .

- b)Plant A. It has the longest petals.
- c)1)Its anther is sticking outside the flower. It enables the slower to disperse its pollen grains by wind more easier.
- 2)Its stigma are large. This helps it to trap pollen grains more easier carried by wind.

44)a)Use magnet K to repel the smaller round magnet measure the distance moved by the smaller round magnet by using the measuring tape. Repeat the whole experiment with magnet L.

- b)The magnet which can attract the smaller round magnet from the further distance is the stronger one.

