



CANDIDATE NAME

CT GROUP

TUTOR NAME

---

**PHYSICS**

**9749/01**

**Paper 1 Multiple Choice**

**20 Sep 2018**

**1 hour**

Additional Materials: Optical Mark Sheet

---

**INSTRUCTIONS TO CANDIDATES**

Write in soft pencil.

Write your name, CT, NRIC or FIN number on the optical mark sheet (OMS). Shade your NRIC or FIN in the spaces provided.

There are **thirty** questions on this paper. Answer **all** questions. For each question, there are four possible answers **A, B, C** and **D**.

Choose the **one** you consider correct and record your choice in **soft pencil** on the OMS.

Each correct answer will score one mark. A mark will **not** be deducted for a wrong answer.

Any rough working should be done in this booklet.

Data	Formulae
speed of light in free space, $c = 3.00 \times 10^8 \text{ m s}^{-1}$	uniformly accelerated motion $s = ut + \frac{1}{2}at^2$ $v^2 = u^2 + 2as$
permeability of free space, $\mu_0 = 4\pi \times 10^{-7} \text{ H m}^{-1}$	work done on / by a gas $W = p \Delta V$
permittivity of free space, $\epsilon_0 = 8.85 \times 10^{-12} \text{ F m}^{-1}$ $\approx (1/(36\pi)) \times 10^{-9} \text{ F m}^{-1}$	hydrostatic pressure $p = \rho gh$
elementary charge, $e = 1.60 \times 10^{-19} \text{ C}$	gravitational potential $\phi = -\frac{Gm}{r}$
the Planck constant, $h = 6.63 \times 10^{-34} \text{ J s}$	temperature $T/K = T/^\circ\text{C} + 273.15$
unified atomic mass constant, $u = 1.66 \times 10^{-27} \text{ kg}$	pressure of an ideal gas $P = \frac{1}{3} \frac{Nm}{V} \langle c^2 \rangle$
rest mass of electron, $m_e = 9.11 \times 10^{-31} \text{ kg}$	mean kinetic energy of a molecule of an ideal gas $E = \frac{3}{2}kT$
rest mass of proton, $m_p = 1.67 \times 10^{-27} \text{ kg}$	displacement of particle in s.h.m. $x = x_0 \sin \omega t$
molar gas constant, $R = 8.31 \text{ J K}^{-1} \text{ mol}^{-1}$	velocity of particle in s.h.m. $v = v_0 \cos \omega t$ $= \pm \omega \sqrt{(x_0^2 - x^2)}$
the Avogadro constant, $N_A = 6.02 \times 10^{23} \text{ mol}^{-1}$	electric current $I = Anvq$
the Boltzmann constant, $k = 1.38 \times 10^{-23} \text{ J K}^{-1}$	resistors in series $R = R_1 + R_2 + \dots$
gravitational constant, $G = 6.67 \times 10^{-11} \text{ N m}^2 \text{ kg}^{-2}$	resistors in parallel $1/R = 1/R_1 + 1/R_2 + \dots$
acceleration of free fall, $g = 9.81 \text{ m s}^{-2}$	electric potential $V = \frac{Q}{4\pi\epsilon_0 r}$
	alternating current / voltage $x = x_0 \sin \omega t$
	magnetic flux density due to a long straight wire $B = \frac{\mu_0 I}{2\pi d}$
	magnetic flux density due to a flat circular coil $B = \frac{\mu_0 NI}{2r}$
	magnetic flux density due to a long solenoid $B = \mu_0 ni$
	radioactive decay $x = x_0 \exp(-\lambda t)$
	decay constant $\lambda = \frac{\ln 2}{t_{\frac{1}{2}}}$

- 1 Which of the following statements is correct?
- A Density is mass per cubic metre.  
 B Potential difference is energy per unit current.  
 C Speed is distance travelled per second.  
 D Pressure is force per unit area.
- 2 An elevator is moving downwards with an acceleration of  $5.8 \text{ m s}^{-2}$ . A ball, held  $2.0 \text{ m}$  above the floor of the elevator and at rest with respect to the elevator, is released. How long does it take for the ball to reach the floor of the elevator?
- A  $0.51 \text{ s}$                       B  $0.64 \text{ s}$                       C  $0.83 \text{ s}$                       D  $1.00 \text{ s}$
- 3 A clay pigeon is launched vertically into the air from the ground.

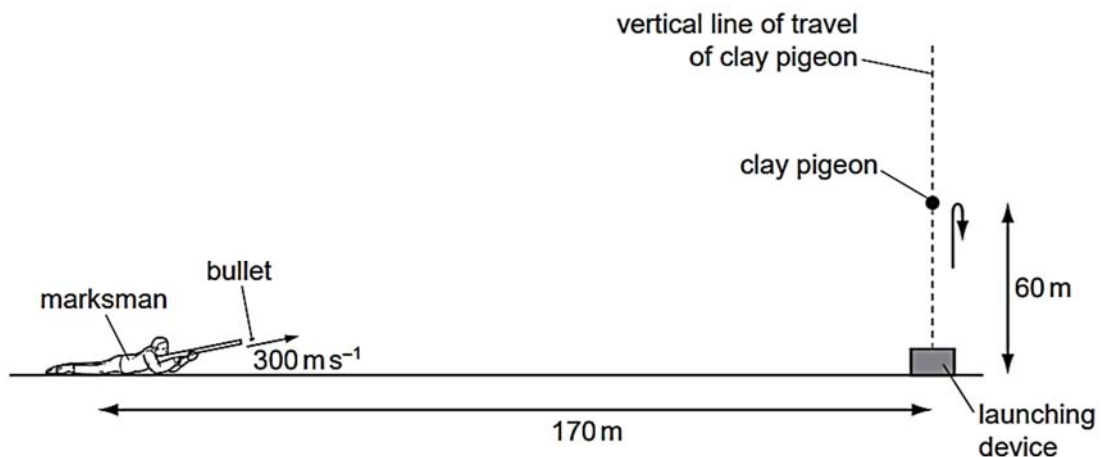

(diagram not to scale)

A marksman lies at a horizontal distance of  $170 \text{ m}$  away from the launching device. When the clay pigeon reaches its maximum height of  $60 \text{ m}$ , the marksman aims his rifle at the clay pigeon and fires a bullet at it. The bullet leaves the rifle with a speed of  $300 \text{ m s}^{-1}$ .

At which time after the bullet is fired, does the bullet hit the clay pigeon? Assume air resistance is negligible.

- A  $0.17 \text{ s}$                       B  $0.57 \text{ s}$                       C  $0.60 \text{ s}$                       D  $1.66 \text{ s}$

- 4 A projectile of mass  $m$  is fired at ground level with velocity  $u$  from a point A, as shown below.



Neglecting air resistance, determine the magnitude of the change in momentum of the mass between leaving point A and arriving back at ground level.

- A zero                      B  $\frac{1}{2} mu$                       C  $mu$                       D  $2mu$
- 5 An empty truck has a mass of 5000 kg. Regardless of the mass of load it has, it experiences a fixed retarding force of 70000 N when it decelerates from a speed of  $50 \text{ m s}^{-1}$  to  $30 \text{ m s}^{-1}$ . The duration for the empty truck to decelerate is  $t_1$ . The duration for it to decelerate when it has a full load of 1300 kg is  $t_2$ .  
What is the difference ( $t_2 - t_1$ )?
- A 0.37 s                      B 0.56 s                      C 0.93 s                      D 1.43 s
- 6 A stationary nucleus of mass number A undergoes a radioactive decay by emitting an alpha particle with velocity  $v$  and a gamma radiation of wavelength  $\lambda$ . The daughter nucleus moves off with velocity  $w$ .

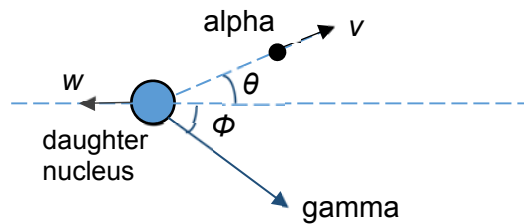

Which of the following equations is correct?

- A  $(A - 4)w = 4v \cos \theta$
- B  $(A - 4)uw = 4uv \cos \theta + \frac{hc}{\lambda} \cos \phi$
- C  $4uv \sin \theta = \frac{hc}{\lambda} \sin \phi$
- D  $4uv \sin \theta = \frac{h}{\lambda} \sin \phi$

- 7 A U-tube has one arm of cross-sectional area  $A$  and the other arm of cross-sectional area  $4A$ . The tube contains water of density  $1000 \text{ kg m}^{-3}$  and oil of density  $850 \text{ kg m}^{-3}$ , as shown.

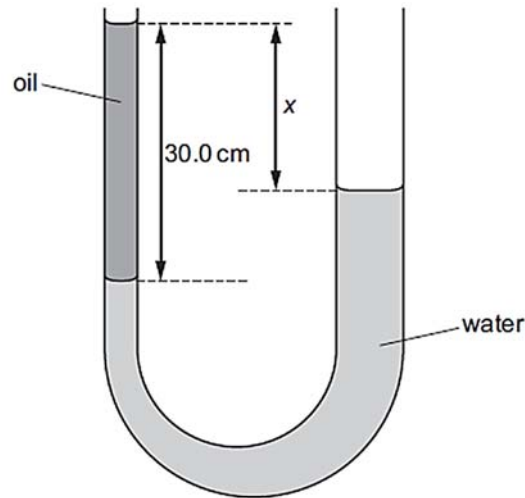

The column of oil on top of the water in the left-hand arm is of length  $30.0 \text{ cm}$ .

What is the difference in height  $x$  between the levels in the two arms of the tube?

- A** 4.5 cm                      **B** 6.2 cm                      **C** 23.8 cm                      **D** 23.5 cm
- 8 When a horizontal force  $F$  is applied to a trolley over a smooth horizontal surface of distance  $x$ , its kinetic energy changes from  $2 \text{ J}$  to  $6 \text{ J}$ .
- If a force  $2F$  is applied to the trolley over a distance of  $2x$ , what will be the final kinetic energy of it? Assume the original kinetic energy of the trolley is  $2 \text{ J}$ .
- A** 12 J                      **B** 16 J                      **C** 18 J                      **D** 24 J

- 9 The figure below shows the variation the force  $F$  applied to an object with the displacement  $s$  of it.

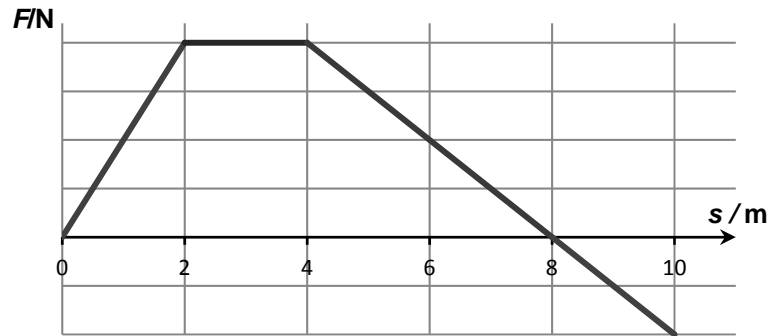

Which of the following graphs correctly shows the variation of the work done by  $F$  on the object with respect to displacement?

(Note the graphs in the following options may not have the same scale for their vertical axes.)

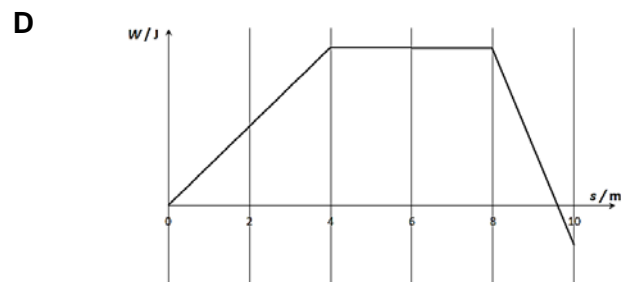
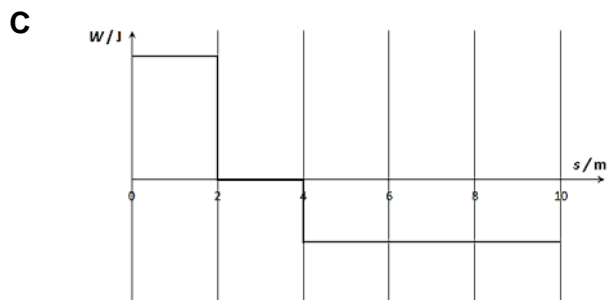
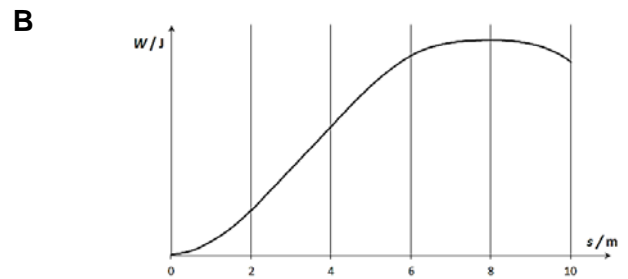
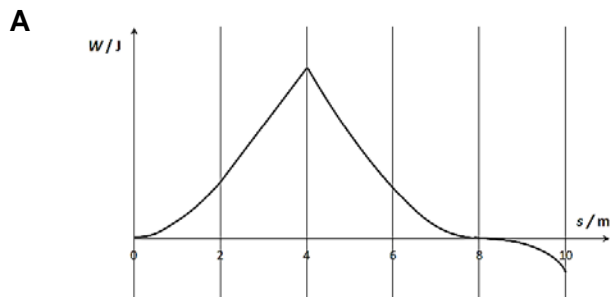

- 10 Two rough discs of mass  $m$  and  $2m$  are placed on a rough, horizontal and level turntable as shown in the diagram. The turntable starts rotating from rest with gradually increasing angular velocity  $\omega$ . Eventually, both discs will slip off the turntable.

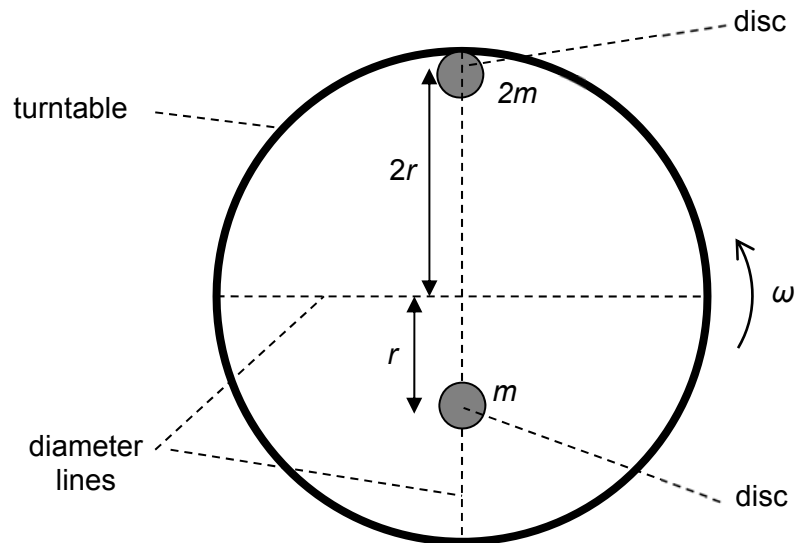

Given that the maximum frictional force acting on mass  $m$  is half of that on mass  $2m$ , which of the following is correct?

- A Disc of mass  $m$  experiences maximum frictional force first.
- B Disc of mass  $2m$  experiences maximum frictional force first.
- C Both discs experience maximum frictional force at the same time.
- D Neither disc will experience maximum frictional force

- 11 A bullet of mass  $m$  and speed  $v$  hits a pendulum bob of mass  $M$  horizontally. Subsequently, it embeds into the bob. The pendulum bob is suspended by a stiff rod of length  $L$  and negligible mass.

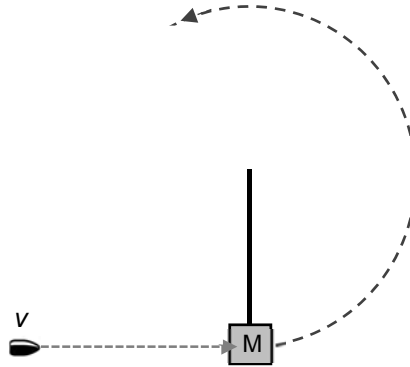

Determine the minimum value of  $v$  such that the pendulum bob will just swing through a complete vertical circle.

- A  $v = \frac{4(m+M)gL}{m}$                       B  $v = \frac{5(m+M)gL}{m}$
- C  $v = \frac{(m+M)\sqrt{4gL}}{m}$                       D  $v = \frac{(m+M)\sqrt{5gL}}{m}$
- 12 A satellite of mass  $m$  is orbiting a planet of mass  $M$  at a radius of  $R$ . How much energy must be provided to bring the satellite to an orbit of radius  $2R$ ?

- A 0    B  $\frac{GMm}{2} \left( \frac{1}{2R} - \frac{1}{R} \right)$
- C  $\frac{GMm}{2} \left( \frac{1}{R} - \frac{1}{2R} \right)$                       D  $GMm \left( \frac{1}{2R} - \frac{1}{R} \right)$



- 13 A system consisting of a large block P with a smaller block Q resting on it, oscillates on a frictionless surface with a frequency of 1.5 Hz. The maximum static friction between the two blocks is 5.0 N.

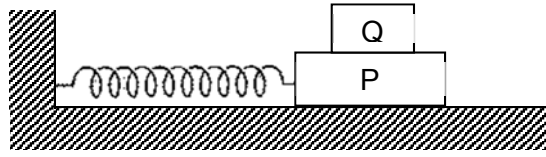

If the mass of P is 2.00 kg and the mass of Q is 0.20 kg, what is the maximum amplitude of oscillation of the system in order that block Q does not slip?

- A 0.28 m                      B 0.056 m                      C 0.028 m                      D 0.026 m
- 14 The diagram shows a setup in which a stationary wave is produced in an air column. A tuning fork, placed above the tube, vibrates and produces a sound wave. The length of the air column can be varied by altering the volume of water in the tube.

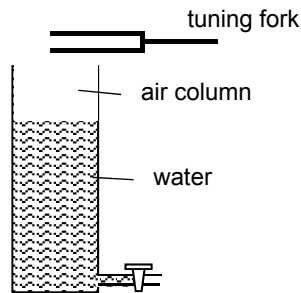

Initially, water is filled to the brim of this tube. The water is allowed to run out of it. Resonance occurs when the air column lengths are 18 cm and 30 cm. Which of the following lengths of air column will **not** result in resonance?

- A 6 cm                      B 24 cm                      C 42 cm                      D 54 cm
- 15 Light of wavelengths 400 nm and 600 nm are incident normally on a diffraction grating. It was observed that the 400 nm light in one order of the spectrum appears at the same angle as the 600 nm light in the adjacent order.
- Given that the angle is  $30^\circ$ , calculate the spacing between the slits in the grating.

- A  $1.2 \mu\text{m}$                       B  $1.8 \mu\text{m}$                       C  $2.4 \mu\text{m}$                       D  $3.6 \mu\text{m}$

- 16 Two vessels X and Y contain ideal gases at the same temperature  $T$ . The pressures of ideal gases in X and Y are  $P$  and  $P/4$  respectively. The volume of X is 1.5 times that of Y. The vessels are connected by a narrow tube with a tap. The tap is initially closed. The temperature of the gas is maintained at the constant temperature  $T$ .

What is the pressure of the gas at equilibrium when the tap is opened?

- A  $0.50 P$                       B  $0.70 P$                       C  $0.75 P$                       D  $1.50 P$

- 17 The graph shows the variation of temperature  $T$  against time  $t$  of a certain substance. Originally, it is in a liquid state at  $t = 0$  s. Heat is removed from it at a constant rate until it becomes a solid.

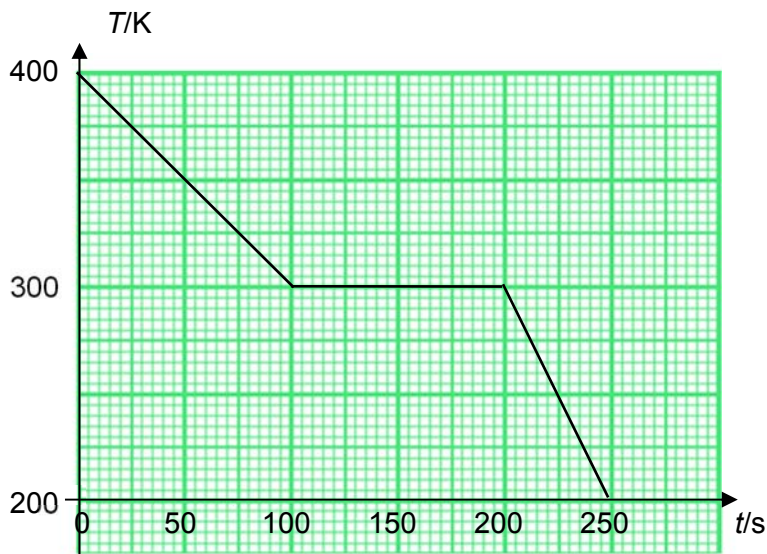

Which of the following could be correct?

	specific heat capacity of liquid / $\text{J kg}^{-1} \text{K}^{-1}$	specific heat capacity of solid / $\text{J kg}^{-1} \text{K}^{-1}$
A	1500	3000
B	1800	900
C	2500	2500
D	4500	3000

- 18 The figure below shows two charged oil drops, X and Y, of masses  $2m$  and  $m$  respectively, which are just prevented from falling under gravity by the application of a voltage between the two parallel metal plates.

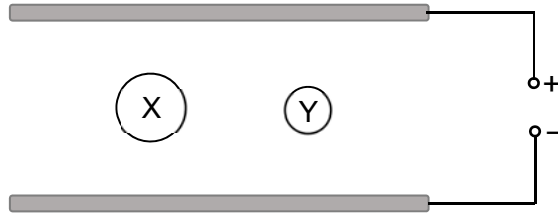

Which of the following correctly describes what will happen if the plates are moved further apart?

- A Both X and Y will move up with the same acceleration.  
 B Both X and Y will move down with the same acceleration.  
 C X will begin to move down with an acceleration greater than that of Y.  
 D X will begin to move down with an acceleration smaller than that of Y.
- 19 The diagram below shows the electric field lines in a region of space.

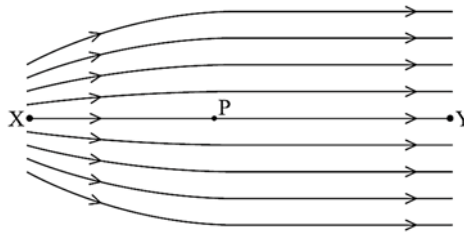

Which of the following diagrams shows the variation with distance  $d$  of the potential  $V$  along the line XY?

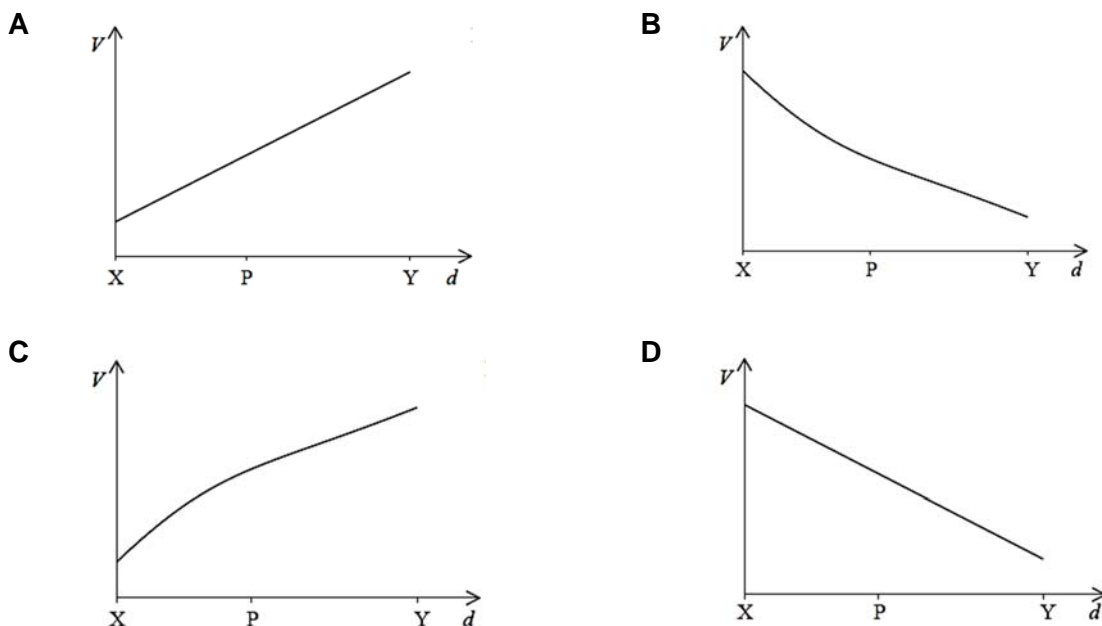

- 20 A network is constructed using eight resistors, each of resistance  $R$ , and three switches  $S_1$ ,  $S_2$  and  $S_3$ .

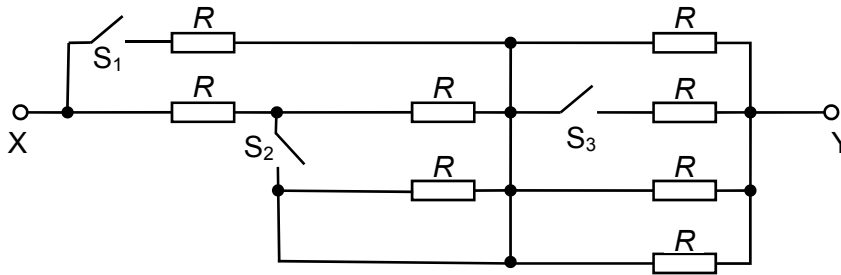

Which of the following combination will give rise to the minimum total resistance between points X and Y?

- |   | $S_1$  | $S_2$  | $S_3$  |
|---|--------|--------|--------|
| A | closed | closed | closed |
| B | closed | open   | closed |
| C | open   | closed | closed |
| D | open   | open   | open   |
- 21 A row of 30 decorative lights, connected in series, is connected to a mains transformer. When the supply is switched on, the lights do not work. The owner uses a voltmeter to test the circuit. When the voltmeter is connected across the fifth bulb in the row, a reading of zero is obtained.
- Which of the following scenarios described is **not** possible?
- A Only the filament of the fifth bulb has broken.
  - B The fuse in the mains transformer has blown.
  - C The filament of at least one of the other bulbs has broken.
  - D There is a break in the wire from the supply to the transformer.

- 22 The diagram below illustrates one of the earliest designs of a galvanometer. A coil of wire is wound around a circular iron core which is placed between two magnets with circular surfaces such that the magnetic field (indicated by the arrows) on the surface of the iron core is directed perpendicularly onto the surface and of the same magnitude across the surface of the iron core as shown in the diagram.

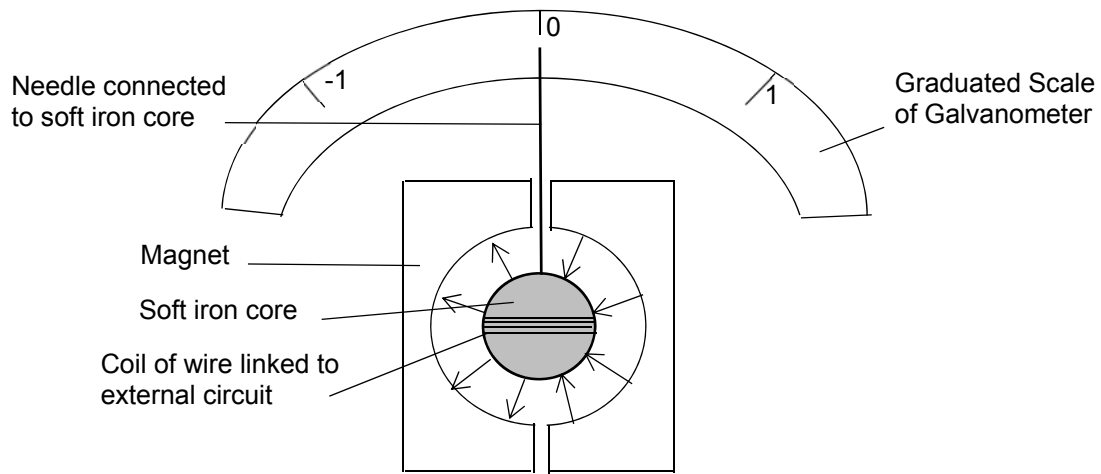

When a constant current flows in the coil, the needle will be deflected to an angle  $\theta_0$  from the vertical direction. Which of the following graphs show the variation of the torque on the soft iron core  $\tau$ , due to magnetic forces acting on the coil, with the angular displacement  $\theta$  of the needle as the needle rotates from 0 to  $\theta_0$ ?

A

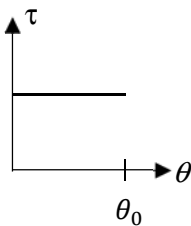

B

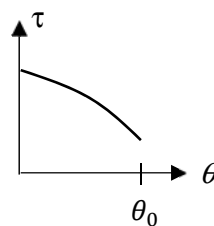

C

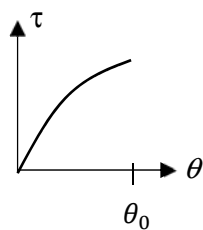

D

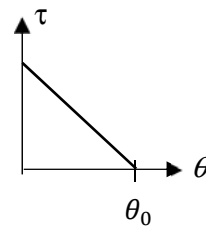

- 23 A coil of wire of 3 turns and cross sectional area of  $0.30 \text{ m}^2$  is placed on the ground. Earth's magnetic field is  $0.045 \text{ T}$  and is directed at an angle of  $60^\circ$  below horizontal.

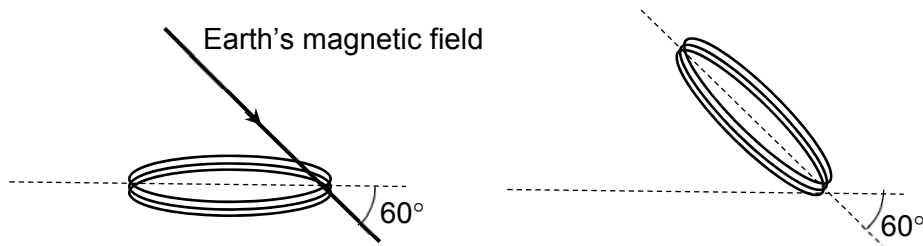

What is the magnitude of the change in magnetic flux linkage of the coil of wire if it is lifted on one side such that it is now parallel to the Earth's magnetic field?

- A 0.020 Wb turns    B 0.035 Wb turns    C 0.040 Wb turns    D 0.070 Wb turns
- 24 A magnet is attached to a motor and rotates below a freely-suspended copper disc as shown below.

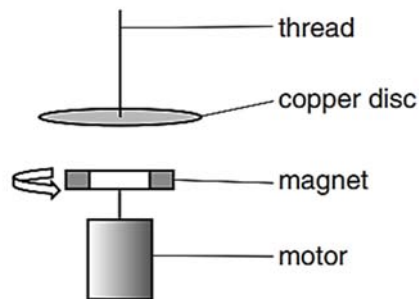

Which of the following statements is correct?

- A The disc remains stationary as copper is not magnetic.  
 B The disc rotates in the same direction as the magnet as copper is magnetic.  
 C The disc rotates in the same direction as the magnet as eddy currents are induced in the disc.  
 D The disc rotates in the opposite direction as the magnet as eddy currents are induced in the disc.
- 25 A non-ideal transformer with an efficiency of 0.75, is connected to a  $120 \text{ V}$  a.c. supply and a  $8.0 \Omega$  resistor. The secondary coil of the transformer has twice as many turns as the primary coil.

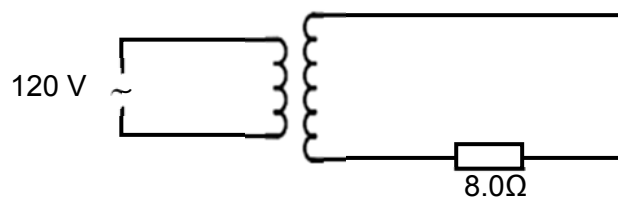

Assuming there is no flux leakage between the primary and secondary coils, what is the current in the primary coil?

- A 15 A    B 30 A    C 60 A    D 80 A

- 26 It is written on a label attached to a kettle that the power consumption of the kettle is 2.0 kW for 240 V r.m.s. alternating supply. The kettle is connected to an alternating mains supply of 120 V r.m.s.. How much energy is consumed if the kettle is used for 1.5 hours?

A 0.50 kWh      B 0.75 kWh      C 1.5 kWh      D 3.0 kWh

- 27 The diagram shows a circuit used for the investigation of photoelectric emission. The two electrodes E and F are made of different metals. The work function of electrode E is higher than that of electrode F.

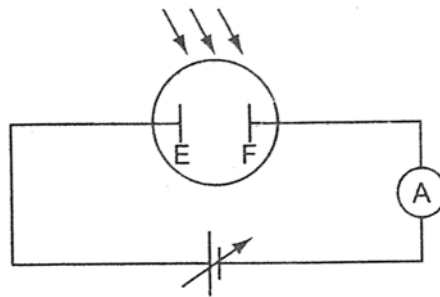

Which of the following graphs show the variation the current (flows from E to F) versus voltage (of E with respect to F) when the two electrodes are illuminated with a uniform monochromatic light? Assume the magnitude of the saturation current for either electrode is same during this experiment.

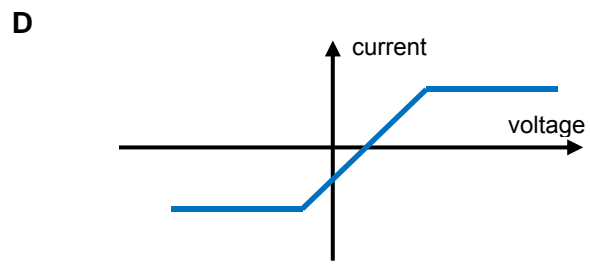
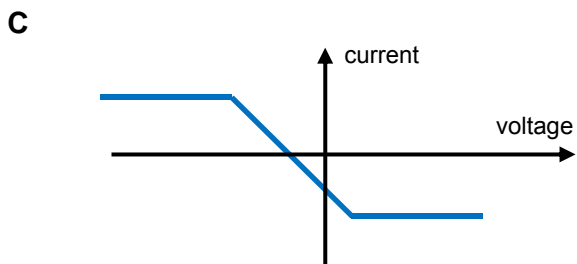
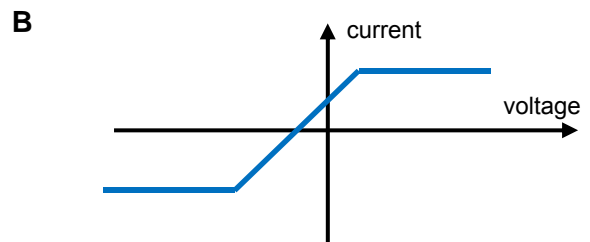
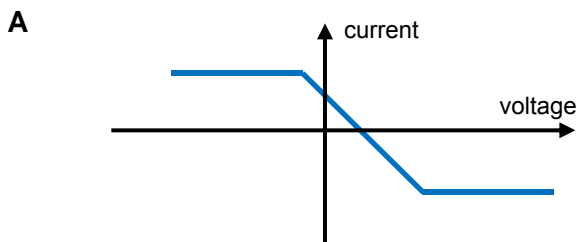

- 28 The X-ray spectrum obtained by bombarding a molybdenum target with electrons is shown in the figure.

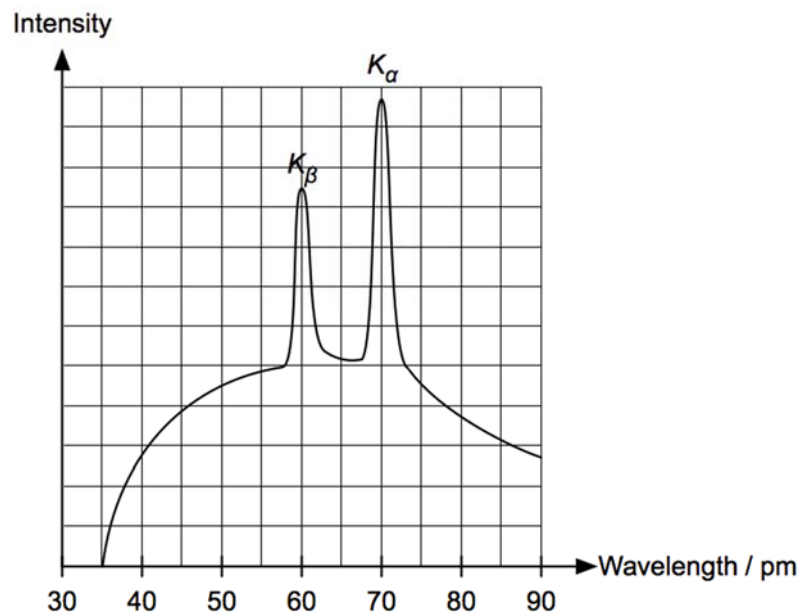

The two peaks  $K_\alpha$  and  $K_\beta$  are produced when the electrons in the lowest energy level of the molybdenum atoms are knocked out by the incident electrons and electrons in the next two higher energy levels of the atom made the transition to the lowest energy level.

What is the energy difference of the two higher energy levels?

- A 21 keV                      B 18 keV                      C 13 keV                      D 3 keV
- 29 Which of the following combinations of radioactive decay results in the formation of an isotope of the original nucleus?
- A one  $\alpha$  and four  $\beta$  decays  
 B one  $\alpha$  and two  $\beta$  decays  
 C two  $\alpha$  and two  $\beta$  decays  
 D four  $\alpha$  and one  $\beta$  decays
- 30 A radioactive source consists of a mixture of two isotopes P and Q. P has a half-life of 60 minutes and Q has a half-life of 30 minutes. The initial activity recorded by a suitable counter is  $800 \text{ min}^{-1}$ . After 120 minutes, the counter registers an activity of  $80 \text{ min}^{-1}$ . What is the initial contribution of P to the count rate?
- A  $160 \text{ min}^{-1}$                       B  $240 \text{ min}^{-1}$                       C  $270 \text{ min}^{-1}$                       D  $480 \text{ min}^{-1}$

**END OF PAPER**



Qn	Ans	Explanation
1	D	A quantity is defined with quantities and not units.
2	D	<p>Distance travelled by ball <math>s_b = 0 + \frac{1}{2}(9.8)t^2</math>,</p> <p>Distance travelled by elevator <math>s_e = 0 + \frac{1}{2}(5.8)t^2</math>,</p> $2.0 = \frac{1}{2}(9.8)t^2 - \frac{1}{2}(5.8)t^2 \Rightarrow t = 1.00 \text{ s}$
3	C	$\theta = \tan^{-1} \frac{60}{170}$ <p>Consider horizontal motion:</p> $t = \frac{s_x}{u_x} = \frac{170}{300 \cos \theta} = 0.60 \text{ s}$
4	C	<p>Change in momentum = mass x change in velocity.                      Change in velocity = final velocity – initial velocity.                      However, velocity is a vector and vectors cannot be “simply” subtracted.                      Thus, the subtraction has to be changed into an addition: <math>\Delta v = v_f - v_i = v_f + (-v_i)</math>.                      From the vector addition diagram, since <math> v_f  =  v_i  =  u </math></p> $\Delta v = 2u \sin 30^\circ = u$ $\Delta p = m \Delta u = mu$
5	A	<p>When the truck is <b>empty</b>, by Newton’s second law,</p> $F_{\text{net}} = m a$ $(-70\,000) = (5\,000) a$ $a = (-70\,000) / (5\,000) = -14.0 \text{ m s}^{-2}$ $t_1 = (v - u) / a = (30 - 50) / (-14.0) = 1.43 \text{ s.}$ <p>When the truck is <b>full</b>, by Newton’s second law,</p> $F_{\text{net}} = m a$ $(-70\,000) = (5\,000 + 1\,300) a$ $a = (-70\,000) / (6\,300) = 11.1 \text{ m s}^{-2}$ $t_2 = (v - u) / a = (30 - 50) / (11.1) = 1.80 \text{ s.}$ <p>The difference <math>(t_2 - t_1) = 1.80 - 1.43 = 0.37 \text{ s.}</math></p>

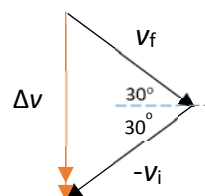

6	D	The equation is for the conservation of linear momentum in the vertical direction.
7	A	Pressure at the boundary between the oil and water in the left arm is the same as the pressure at the same height due to water on the right arm. $30.0\rho_{oil}g = (30.0 - x)\rho_{water}g \Rightarrow x = 4.5 \text{ cm}$
8	C	By conservation of energy, work done by the force $W =$ gain in kinetic energy $\Delta K$ $\frac{\Delta K'}{W} = \frac{W'}{W} = \frac{(2F)(2x)}{Fx} = 4 \Rightarrow \Delta K' = (4)(6\text{J}-2\text{J})=16 \text{ J}$ New kinetic energy $K' = 16 + 2 = 18 \text{ J}$
9	B	Area under the $F - x$ graph = work done by force. The work done keeps increasing until the force becomes negative.
10	B	When maximum friction force is experienced for each of the discs: <u>For m:</u> <i>friction, <math>f = mr\omega_1^2</math></i> , where $\omega_1$ is the angular velocity just as disc slips off $\omega_1^2 = \frac{f}{mr}$ <u>For 2m:</u> <i>friction, <math>(2f) = (2m)(2r)\omega_2^2</math></i> , where $\omega_2$ is the angular velocity just as disc slips off $\omega_2^2 = \frac{f}{2mr}$ As the angular velocity is gradually increased, it will reach $\omega_2$ before $\omega_1$ . Hence the 2m disc will experience maximum friction
11	C	Applying conservation of linear momentum to the collision: $mv = (m + M)v_1$ To complete the vertical circle, the speed at the top can just be zero, unlike the case for string. Applying conservation of energy to the top and bottom of the circle: $(m + M)g(2L) = \frac{1}{2}(m + M)v_1^2$ $v_1 = \sqrt{4gL}$ Therefore $v = \frac{(m + M)\sqrt{4gL}}{m}$
12	C	For a satellite that is in orbit, the gravitational force provides for the centripetal force, $G\frac{Mm}{r^2} = m\frac{v^2}{r}$ $mv^2 = G\frac{Mm}{r}$ The initial energy is the total energy of the satellite in orbit at radius $R$ $TE_{\text{initial}} = KE + GPE = \frac{1}{2}mv^2 - \frac{GMm}{R} = \frac{GMm}{2R} - \frac{GMm}{R} = -\frac{1}{2}\frac{GMm}{R}$ The final energy is the total energy of the satellite at radius $2R$ is

		$TE_{\text{final}} = -\frac{1}{2} \frac{GMm}{2R}$ <p>Energy needed = final energy – initial energy</p> $= -\frac{1}{2} \frac{GMm}{2R} - \left( -\frac{1}{2} \frac{GMm}{R} \right) = \frac{GMm}{2} \left( \frac{1}{R} - \frac{1}{2R} \right)$
13	A	<p>The frictional force is the restoring force.</p> $\sum F = ma = m\omega^2 x$ $5.0 = 0.20 \times (2\pi \times 1.5)^2 x_0$ $x_0 = 0.28 \text{ m}$
14	B	<p>For a closed pipe, the resonant lengths are odd multiples of the shortest length.</p> <p>Taking the ratio of the 2 given lengths 30/18 gives 5/3. Hence 30 is the 5<sup>th</sup> resonance length while 18 is the third resonance length, and the shortest length is 6 cm. All odd multiples of 6 cm produces resonance.</p>
15	C	<p>Since the orders overlap at the same angle:</p> $n_1 \lambda_1 = n_2 \lambda_2$ $\frac{n_1}{n_2} = \frac{\lambda_2}{\lambda_1} = \frac{400}{600} = \frac{2}{3}$ <p>Therefore the second order 600 nm is overlapping with the third order 400 nm.</p> <p>Using <math>d = \frac{n\lambda}{\sin \theta} = \frac{2(600 \times 10^{-9})}{\sin 30^\circ} = 2.4 \times 10^{-6} \text{ m}</math></p>
16	B	<p>Initial state,</p> <p>X: <math>P \times 1.5 \text{ V} = n_1 RT</math> ----- (1)</p> <p>Y: <math>\frac{P}{4} \times V = n_2 RT</math> ----- (2)</p> <p>Final state, conserving the mass (number of moles):</p> $P' (2.5V) = 1.5PV + \frac{PV}{4}$ $P' = 0.7 P$
17	B	<p>Heat was removed from it at a constant rate.</p> $m(\text{specific heat capacity of liquid})(400 - 300)/(100)$ $= m(\text{specific heat capacity of solid})(300 - 200)/(50)$ <p>(specific heat capacity of liquid) = 2 X (specific heat capacity of solid)</p>
18	B	<p>Since both X and Y are stationary and the mass of X is twice of Y, we can conclude that the charge on X is twice of Y.</p> <p>When the plates are moved further apart, the electric field strength decreases, hence there is a net force acting downwards on both X and Y.</p> <p>Applying Newton's second law:</p> <p>X: <math>2mg - 2qE = 2ma</math></p> <p>Y: <math>mg - qE = ma</math></p>

19	B	$E = -\frac{dV}{dr}$ <p>As indicated from the slope of the V-d graph, <math>E_X &gt; E_P = E_Y</math></p>
20	A	The more the number of parallel connections for the resistors, the lower is the resistance. Short-circuiting any resistance will also reduce the net resistance.
21	A	If only the filament of the fifth bulb has broken, the voltmeter will register a non-zero voltage across the transformer.
22	A	Since the force on the coil is given by $F = B_{\perp}IL$ , the force is constant even as the coil rotates hence the torque is also a constant.
23	B	Magnetic flux linkage is given by $\Phi = NBA\sin 60^{\circ}$
24	C	From the perspective of the copper disc, the magnet seems to rotating so by Lenz's law, in order to 'oppose' the change (which in this case is the rotation of the magnet), the disc will tend to rotate in the same direction as the magnet (so that the magnet will appear 'stationary' from the disc's perspective)
25	D	<p>Since transformer has turn ratio of 2, secondary voltage is 240V.</p> <p>Hence power consumed is <math>P = \frac{(240)^2}{8} = 7200W</math></p> <p>Since transformer has efficiency of 0.75, power drawn from a.c. supply is <math>P_{ac} = \frac{7200}{0.75} = 9600W</math></p> <p>Hence current in primary coil is given by <math>I = \frac{P_{ac}}{V} = \frac{9600}{120} = 80A</math></p>
26	B	Since $P \sim V^2$ , if kettle is connected to mains voltage that is half the recommended value, its power consumption will be only a quarter, ie 0.5kW. Hence energy consumed in 1.5h is 0.75 kWh.
27	B	<p>When p.d. across E and F are zero, the electrode with a lower work function will emit more electrons upon illumination – electrode F. When there is a net electron flowing from F to E, a current flows from E to F will be positive in graph.</p> <p>To have a zero current, the voltage of electrode F with lower work function should be made more positive with respect to electrode E; i.e. voltage of E with respect to F is negative when current is zero.</p>
28	D	$\Delta E = [hc/(60 \times 10^{-12}) - hc/(70 \times 10^{-12})] / (1.6 \times 10^{-19}) = 3 \text{ keV}$
29	B	Isotopes have the same number of protons but different number of neutrons. By emitting one $\alpha$ and two $\beta$ particles, the number of protons of the element will be conserved (while the number of neutrons changes).
30	A	<p>Initially: <math>P + Q = 800</math></p> <p>After 120 min, <math>\frac{1}{4}P + \frac{1}{16}Q = 80</math></p> <p>Therefore <math>P = 160</math></p>



**HWA CHONG INSTITUTION**  
**JC2 Preliminary Examination**  
**Higher 2**

**CANDIDATE NAME**

**CT GROUP**

**CENTRE NUMBER**

**INDEX NUMBER**

**PHYSICS**

**9749/02**

**Paper 2 Structured Questions**

**14 September 2018**

**2 hours**

Candidates answer on the Question Paper.

No Additional Materials are required.

**INSTRUCTIONS TO CANDIDATES**

Write your **Centre number**, **index number**, **name** and **CT class** clearly on all work you hand in.

Write in dark blue or black pen on both sides of the paper.

You may use an HB pencil for any diagrams or graphs.

Do not use staples, paperclips, highlighters, glue or correction fluid.

Answer **all** questions.

The number of marks is given in brackets [ ] at the end of each question or part question.

You are reminded of the need for good English and clear presentation in your answers.

<b>For Examiner's Use</b>		
<b>1</b>		<b>10</b>
<b>2</b>		<b>9</b>
<b>3</b>		<b>11</b>
<b>4</b>		<b>11</b>
<b>5</b>		<b>11</b>
<b>6</b>		<b>7</b>
<b>7</b>		<b>21</b>
<b>Deductions</b>		
<b>Total</b>		<b>80</b>

Data	Formulae
speed of light in free space, $c = 3.00 \times 10^8 \text{ m s}^{-1}$	uniformly accelerated motion $s = ut + \frac{1}{2} at^2$ $v^2 = u^2 + 2as$
permeability of free space, $\mu_0 = 4\pi \times 10^{-7} \text{ H m}^{-1}$	work done on / by a gas $W = p \Delta V$
permittivity of free space, $\epsilon_0 = 8.85 \times 10^{-12} \text{ F m}^{-1}$ $\approx (1/(36\pi)) \times 10^{-9} \text{ F m}^{-1}$	hydrostatic pressure $p = \rho gh$
elementary charge, $e = 1.60 \times 10^{-19} \text{ C}$	gravitational potential $\phi = -\frac{Gm}{r}$
the Planck constant, $h = 6.63 \times 10^{-34} \text{ J s}$	temperature $T/\text{K} = T/^\circ\text{C} + 273.15$
unified atomic mass constant, $u = 1.66 \times 10^{-27} \text{ kg}$	pressure of an ideal gas $P = \frac{1}{3} \frac{Nm}{V} \langle c^2 \rangle$
rest mass of electron, $m_e = 9.11 \times 10^{-31} \text{ kg}$	mean kinetic energy of a molecule of an ideal gas $E = \frac{3}{2} kT$
rest mass of proton, $m_p = 1.67 \times 10^{-27} \text{ kg}$	displacement of particle in s.h.m. $x = x_0 \sin \omega t$
molar gas constant, $R = 8.31 \text{ J K}^{-1} \text{ mol}^{-1}$	velocity of particle in s.h.m. $v = v_0 \cos \omega t$ $= \pm \omega \sqrt{(x_0^2 - x^2)}$
the Avogadro constant, $N_A = 6.02 \times 10^{23} \text{ mol}^{-1}$	electric current $I = Anvq$
the Boltzmann constant, $k = 1.38 \times 10^{-23} \text{ J K}^{-1}$	resistors in series $R = R_1 + R_2 + \dots$
gravitational constant, $G = 6.67 \times 10^{-11} \text{ N m}^2 \text{ kg}^{-2}$	resistors in parallel $1/R = 1/R_1 + 1/R_2 + \dots$
acceleration of free fall, $g = 9.81 \text{ m s}^{-2}$	electric potential $V = \frac{Q}{4\pi\epsilon_0 r}$
	alternating current / voltage $x = x_0 \sin \omega t$
	magnetic flux density due to a long straight wire $B = \frac{\mu_0 I}{2\pi d}$
	magnetic flux density due to a flat circular coil $B = \frac{\mu_0 NI}{2r}$
	magnetic flux density due to a long solenoid $B = \mu_0 nI$
	radioactive decay $x = x_0 \exp(-\lambda t)$
	decay constant $\lambda = \frac{\ln 2}{t_{\frac{1}{2}}}$

**[BLANK PAGE]**

Answer **all** questions in the spaces provided.

- 1 (a) A spring, which has an unstretched length of 0.650 m, is attached to a fixed point. A mass of 0.400 kg is attached to the spring and gently lowered until equilibrium is reached. The spring has then stretched elastically by a distance of 0.200 m.

Calculate, for the stretching of the spring,

- (i) the loss in gravitational potential energy of the mass,

loss = ..... J [1]

- (ii) the elastic potential energy gained by the spring.

gain = ..... J [2]

- (b) Explain why the two answers to (a) are different.

.....

.....

..... [2]



- (c) The mass on the spring is now set into simple harmonic motion by pulling it downwards by an additional 0.100 m and released from rest.

The angular frequency  $\omega$  of a spring-mass system is given by  $\omega = \sqrt{\frac{k}{m}}$ , where  $k$  is the force constant and  $m$  is the mass of the load.

- (i) Calculate the maximum speed of the mass,

maximum speed = ..... m s<sup>-1</sup> [2]

- (ii) The velocity-displacement graph of the mass is shown in Fig. 1.1. Label on the graph the point **P** when the mass is first released and point **Q** when it first returns to its equilibrium position. Include numerical values on the axes. Take upwards to be positive. [1]

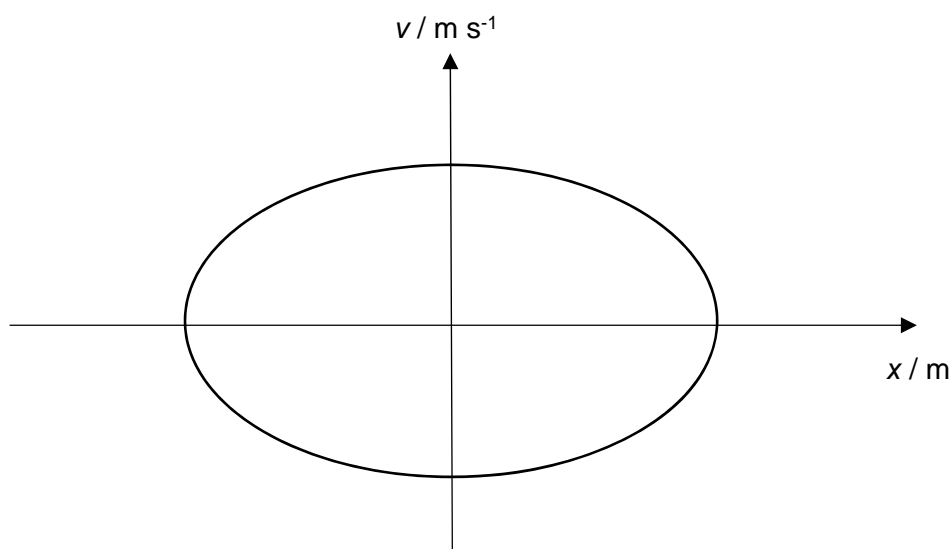

Fig. 1.1

- (iii) The mass is now lowered into a container of water until it is completely submerged. The mass is again displaced downwards from its equilibrium position by 0.100 m and released from rest. Throughout the oscillations, the mass remains under water.

Sketch on Fig. 1.1 the variation of velocity with respect to displacement for one complete oscillation of the mass. [2]

- 2 (a) State the principle of conservation of linear momentum.

.....  
 .....

[1]

- (b) A light and long string (string 1), runs over two smooth and light pulleys (pulleys A and B). One end of the string is fixed to the ceiling and the other end is attached to mass  $M_1$ . Pulley A is fixed to the ceiling while pulley B is movable and is attached to mass  $M_2$  via another light string (string 2).

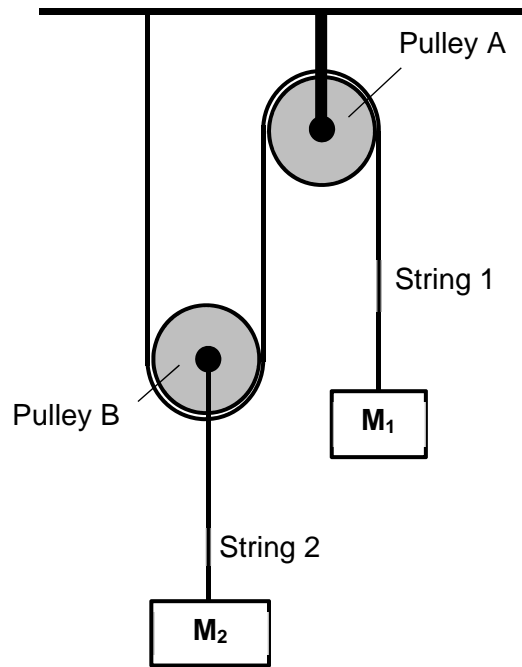

Fig. 2.1

- (i) Given that  $M_1 = 4.0$  kg and  $M_2 = 8.0$  kg and they are both at rest, determine the tension in string 1 and string 2.

tension in string 1 = ..... N

tension in string 2 = ..... N [2]

- (ii) A little disturbance is made to the system and  $M_1$  starts to move upward with speed  $v_1$  while  $M_2$  starts to move downwards with  $v_2$ . By considering linear momentum, express  $v_2$  in terms of  $v_1$ .

$$v_2 = \dots\dots\dots [2]$$

- (iii) Hence, determine the energy introduced to the system due to the disturbance in terms of  $v_1$ .

$$\text{energy} = \dots\dots\dots [2]$$

- (iv) After some time, the masses move with constant speed. Show that total energy of the system is conserved. Explain your working clearly. [2]

3 (a) A commonly used quantity in astronomy is *luminosity*. The luminosity of a star is the total energy radiated by the star per second.

(i) The luminosity of our sun is  $3.826 \times 10^{26} \text{ J s}^{-1}$ . The mean distance of the Earth from the sun is  $1.496 \times 10^8 \text{ km}$ . Determine the intensity of light reaching the Earth.

intensity = .....  $\text{W m}^{-2}$  [2]

(ii) A student, using a photometer that measures the intensity of visible light, measures the intensity of sunlight at noon to be less than the value calculated in (a)(i). Suggest a reason for this observation.

.....  
 .....  
 ..... [1]

(iii) A photometer of area  $4.00 \times 10^2 \text{ cm}^2$  is aimed directly at the sun at the top of a building. Determine the maximum power incident on the photometer.

maximum power = .....  $\text{W}$  [2]

- (b) Fig. 3.1 shows the displacement  $y$  of a particle in a sinusoidal wave as a function of time  $t$ .

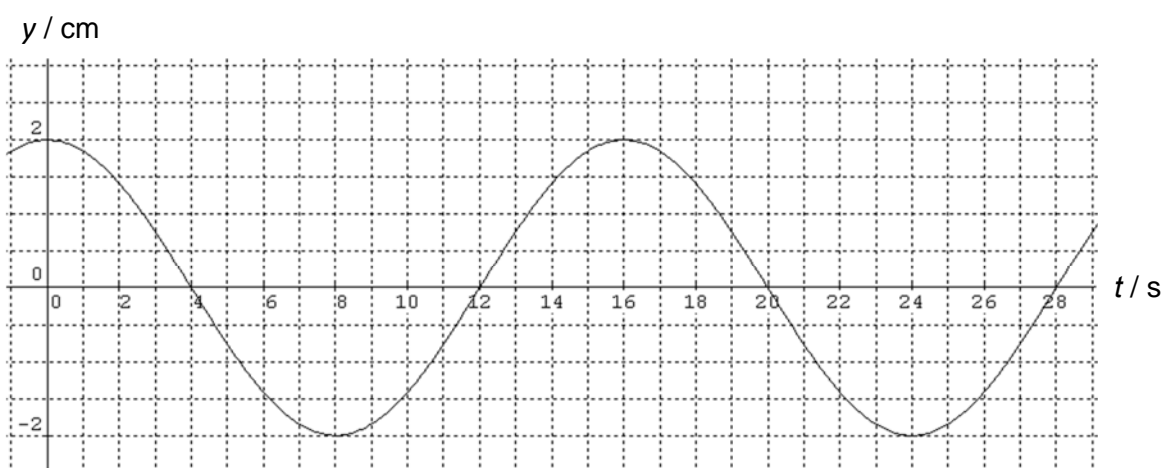

**Fig 3.1**

- (i) Using Fig. 3.1, write an equation that represents the displacement  $y$  of the particle in terms of  $t$ .

$$y = \dots\dots\dots [2]$$

- (ii) A second particle is situated nearer to the source of the wave, at a distance  $\frac{\lambda}{4}$  from the first. Determine the phase difference between the vibrations of the two particles.

$$\text{phase difference} = \dots\dots\dots [2]$$

- (iii) Sketch in Fig. 3.1 to illustrate the variation with time of the displacement of the second particle. [2]

4 (a) State what is meant by an electric field.

.....  
 .....

[1]

(b) Fig. 4.1 below shows a set of equipotential lines of a region of an electric field.

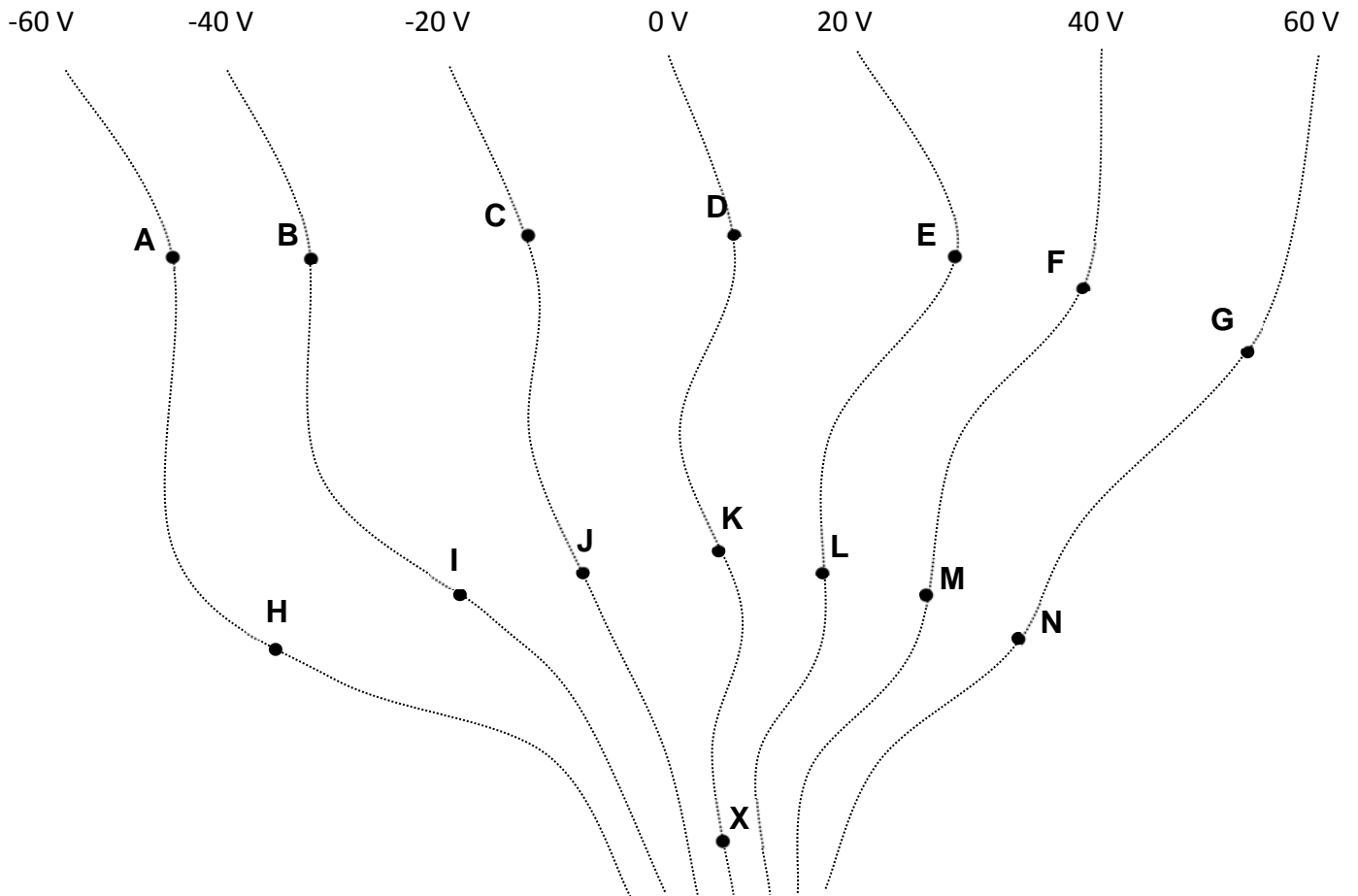

Fig. 4.1 (drawn to scale)

(i) Given that the same field line passes through the points **A,B,C,D,E,F** and **G**, draw in Fig. 4.1, this field line, clearly indicating the direction of the field. [2]

(ii) Explain whether the field is stronger at **D** or at **X**.

.....  
 .....

[1]

- (iii) A charge  $Q_1$  of  $-5.0 \mu\text{C}$  is placed at the point **L**. Calculate the electric potential energy of the charge  $Q_1$  at point **L**.

electric potential energy = ..... J [2]

- (iv) Charge  $Q_1$  is now released from rest. Given that work done on it *by the electric field* is  $1.0 \times 10^{-4}$  J, identify the point(s) that can represent the final location of  $Q_1$ .

Point(s): ..... [2]

- (v) Charge  $Q_1$  is now removed, and  $Q_2$  of  $-15.0 \mu\text{C}$  is now placed at the point **X**. By making *direct measurements* from the Fig 4.1, determine the electric force experienced by the charge.

Indicate on Fig. 4.1 the direction of the force experienced by  $Q_2$  at **X**.

electric force = ..... N [3]

- 5 (a) The variation with temperature of the resistance  $R_T$  of a thermistor is shown in Fig. 5.1.

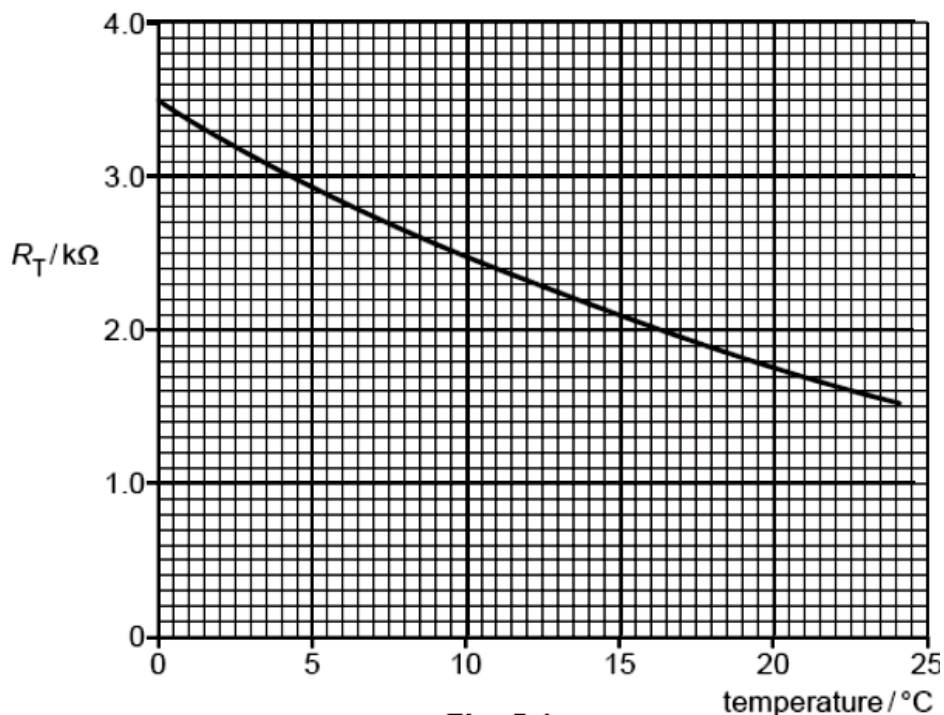

Fig. 5.1

The thermistor is connected in series with a resistor  $R$  as shown in the circuit in Fig. 5.2.

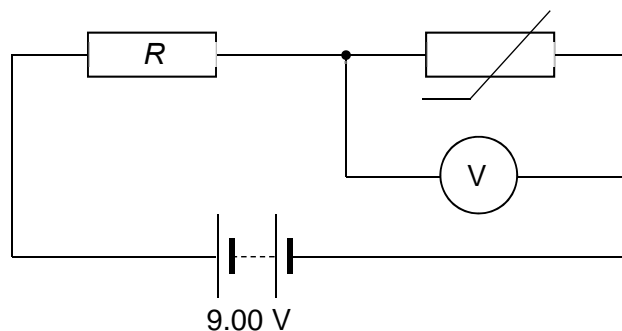

Fig. 5.2

The battery has e.m.f. 9.00 V and negligible internal resistance. The voltmeter has infinite resistance.

- (i) For the thermistor at 22.5 °C, determine the resistance of the thermistor.

$$R_T = \dots\dots\dots \Omega \quad [1]$$

- (ii) Given that the voltmeter reading is 2.70 V, determine the resistance of resistor  $R$ .

$$\text{resistance of } R = \dots\dots\dots \Omega \quad [2]$$



- (b) The voltmeter is now removed from the original circuit and the rest of the circuit is connected to a potentiometer as shown in Fig. 5.3.

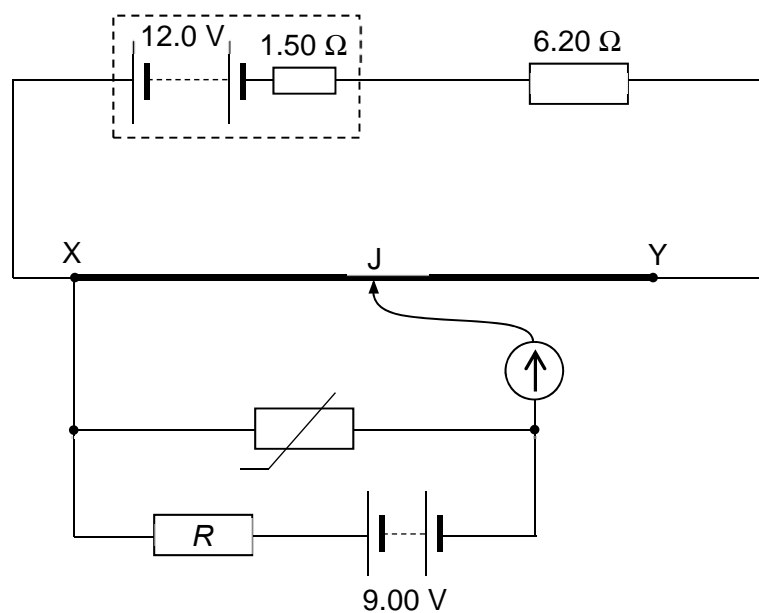

**Fig. 5.3**

The potentiometer has a driver cell of e.m.f. 12.0 V with internal resistance of 1.50  $\Omega$ . It is connected in series with a resistor of resistance 6.20  $\Omega$  and a uniform resistance wire XY, of length 120 cm and radius 0.250 mm. The resistivity of the wire is  $1.10 \times 10^{-6} \Omega \text{ m}$ .

- (i) Determine the resistance of the wire XY.

resistance of wire XY = .....  $\Omega$  [2]

- (ii) For the thermistor at 22.5  $^{\circ}\text{C}$ , determine the balance length XJ where there is no deflection in the galvanometer.

XJ = ..... m [2]

(iii) Explain what will happen to the position of the balance point J if the thermistor is at a temperature of 0 °C.

.....  
.....  
.....

[2]

(iv) Supposed the 6.20  $\Omega$  resistor is replaced by a resistor of smaller resistance, explain what will happen to the position of the balance point J.

.....  
.....  
.....

[2]

- 6 (a) Fig. 6.1 shows the variation of binding energy per nucleon with the number of nucleons in nucleus.

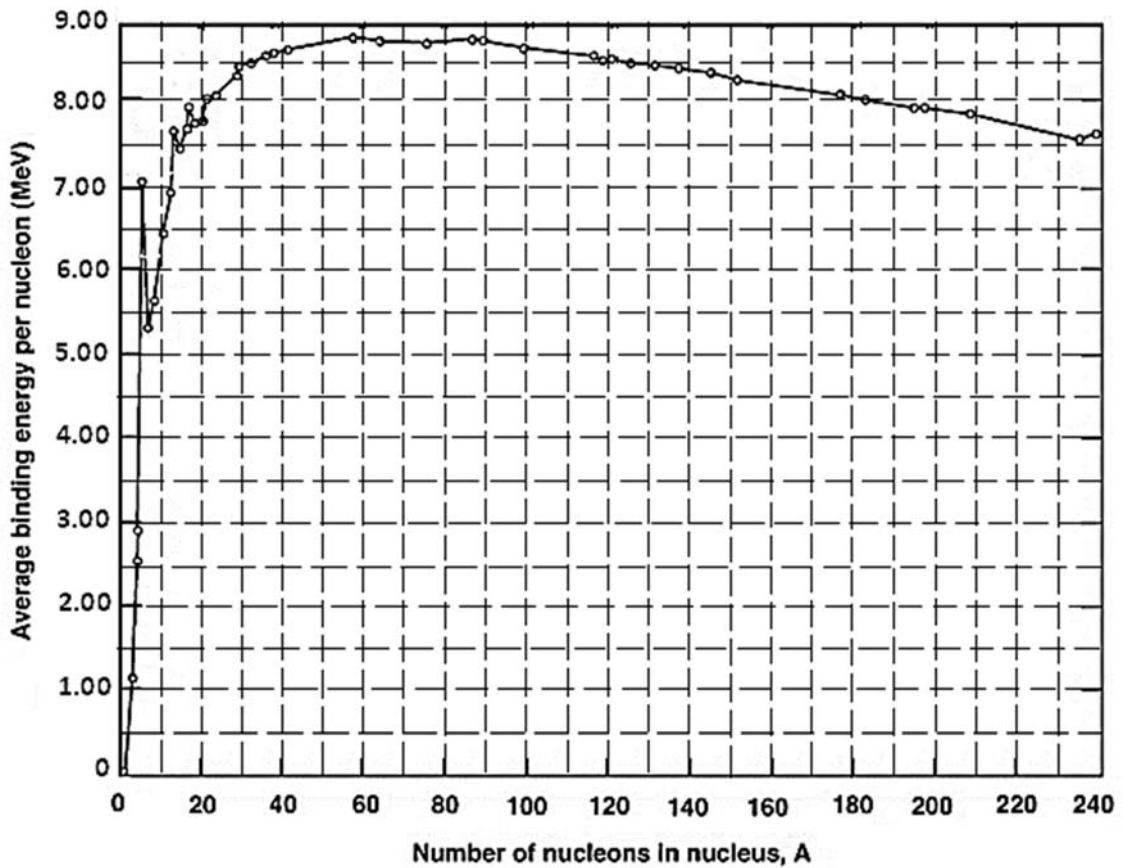

Fig. 6.1

- (i) Define binding energy of a nucleus.

.....  
 .....  
 .....

[1]

- (ii) Using Fig. 6.1, estimate the binding energy of the nucleus Iridium-170,  ${}_{77}^{170}\text{Ir}$ .

binding energy of  ${}_{77}^{170}\text{Ir}$  = ..... MeV [1]

- (iii) Hence calculate the mass defect of  ${}_{77}^{170}\text{Ir}$ .

mass defect of  ${}_{77}^{170}\text{Ir}$  = ..... u [2]

- (b) Stellar nucleosynthesis is a collective term for nuclear reactions taking place in stars. These reactions create nuclei of elements heavier than hydrogen.

The “triple” alpha process is a nuclear fusion reaction that occurs in stars where three alpha particles combine to form carbon-12,  ${}^{12}_6\text{C}$ .

- (i) Determine the energy released in this reaction.

Given:

mass of alpha particle = 4.002603 u

mass of  ${}^{12}_6\text{C}$  = 12.000000 u

energy released = ..... J [2]

- (ii) “Silicon” burning is the final stage of fusion in massive stars. This process involves silicon-28,  ${}^{28}_{14}\text{Si}$  capturing multiple alpha particles, until the sequence terminates at  ${}^{56}_{28}\text{Ni}$ . At this point the star can no longer release energy via nuclear fusion. This eventually results in a catastrophic collapse of the star.

Suggest a reason why the star can no longer release energy via nuclear fusion.

.....

.....

..... [1]

- 7 Read the following article and then answer the questions that follow.

### Physics of Microwave Oven

Microwaves are electromagnetic (e.m.) waves that have frequencies ranging from 300 MHz up to 300 GHz. Following international conventions, microwave ovens operate at frequencies at around 2.45 GHz.

Fig. 7.1. depicts a typical microwave oven. Microwaves are generated in magnetron which feeds via a waveguide into the cooking chamber. The cooking chamber has metallic walls which are able to perfectly reflect the microwaves fed into the cooking chamber, whilst the front door of the microwave is made of glass and is covered by metal grids. The holes in the metal grids are usually 100 times smaller than the wavelength of the microwaves, hence the walls and the grids act like a Faraday's cage.

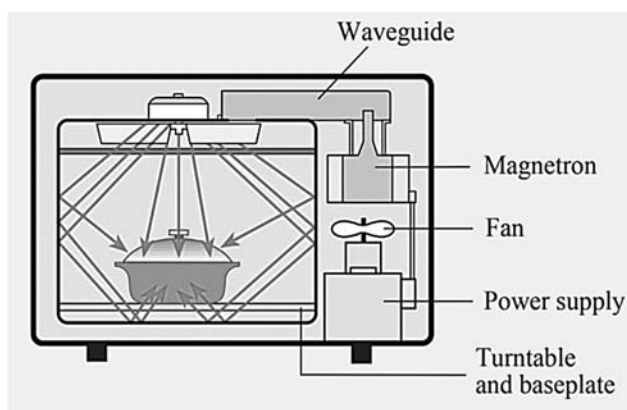

**Fig.7.1.** Schematic diagram of a typical microwave.

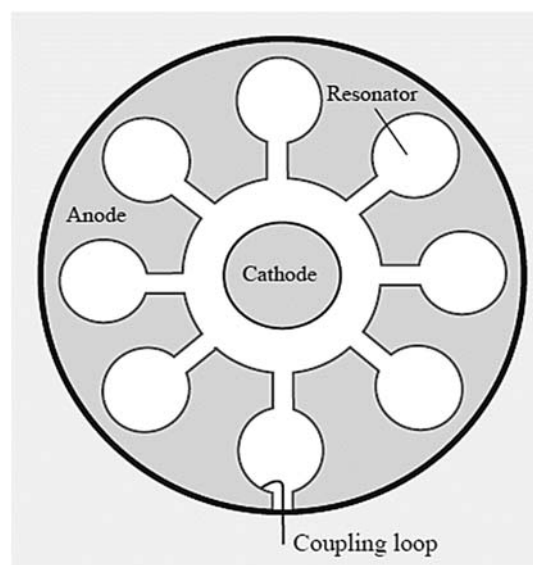

**Fig.7.2.** Schematic diagram of a magnetron

Fig. 7.2 shows the schematic diagram of a magnetron. A cylindrical cathode is at the central axis, several millimetres from a hollow circular anode. Inside the anode there are a number of cavities known as resonators which allows for resonance at 2.45 GHz. A voltage of 5.00 kV is applied between the electrodes and a magnetic field is applied parallel to the axis such that the electric and magnetic fields are perpendicular to each other. In the magnetron, the combined effect of electric and magnetic fields causes the electrons emitted from the hot cathode to travel in curved paths.

So how does the interaction of the molecules in food with the microwaves produce a heating effect to cook food? The water molecules in food oscillate in the alternating electric field of the microwaves. As the individual molecules oscillate, the work done against the forces between neighbour molecules increases their kinetic energy in a random manner, raising the temperature of the food. Fat, sugar and salt in food are able to heat up through a similar mechanism though they often play a smaller role as they are less abundant than water.

The absorption of microwaves by water molecules in the food, is often described as resonance, but this is not true: free water molecules resonate at 22 GHz and 183 GHz. Microwaves with a frequency of 22 GHz would be totally absorbed in the surface of the food without penetrating. If waves with a frequency as low as 100 MHz were used, they would pass straight through the food, and it would not heat up. The choice of 2.45 GHz is a compromise.

Upon entering foods, the intensity of microwaves is gradually reduced along its path according to the relationship:

$$I = I_0 e^{-\mu z}$$

where  $I_0$  is the intensity of the microwave incident on the surface of the food,  $I$  is the microwave intensity in the food at a distance  $z$  below the surface and  $\mu$  is a constant known as the attenuation coefficient.

Another method to characterise the penetration of microwaves in food is using a quantity known as *penetration depth*  $\delta_p$ . It is a quantity that is dependent on the frequency of microwaves incident on the food and is defined as the distance at which the microwave intensity is reduced to  $1/e$  ( $e = 2.718$ ) from the intensity at the point of entry.

*Passage extracted and adapted from "Physics of Microwave Oven" by Michael Volmer and OCR Jan 2004 Paper 2865.*

**(a) (i)** Suggest what is the function of a 'Faraday's cage'.

.....

..... [1]

**(ii)** Estimate a suitable spacing for the holes in the metal grids used in the front door of a microwave oven.

spacing = ..... m [2]

- (b) Fig. 7.3 shows a simplified model of part of the magnetron. The electric field between the cathode and anode is illustrated.

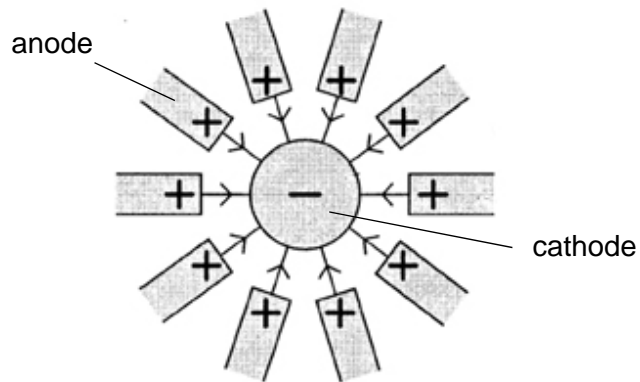

Fig. 7.3

- (i) Show that the maximum kinetic energy that an electron can gain when moving to the anode is  $8.0 \times 10^{-16} \text{ J}$ . [1]

- (ii) Hence, if the microwave power output of the magnetron is about 1 000 W, determine the least number of electrons that must be emitted by the cathode each second.

least number of electrons per second = ..... [1]

- (iii) Suggest one reason why the actual number of electrons emitted is likely to be larger than your answer to (b)(ii).

.....  
 ..... [1]

- (iv) Fig. 7.4 shows the trajectory of an electron of mass  $m$  and charge  $q$  moving at a speed  $v$  in the magnetic field of flux density  $B$  inside a magnetron.

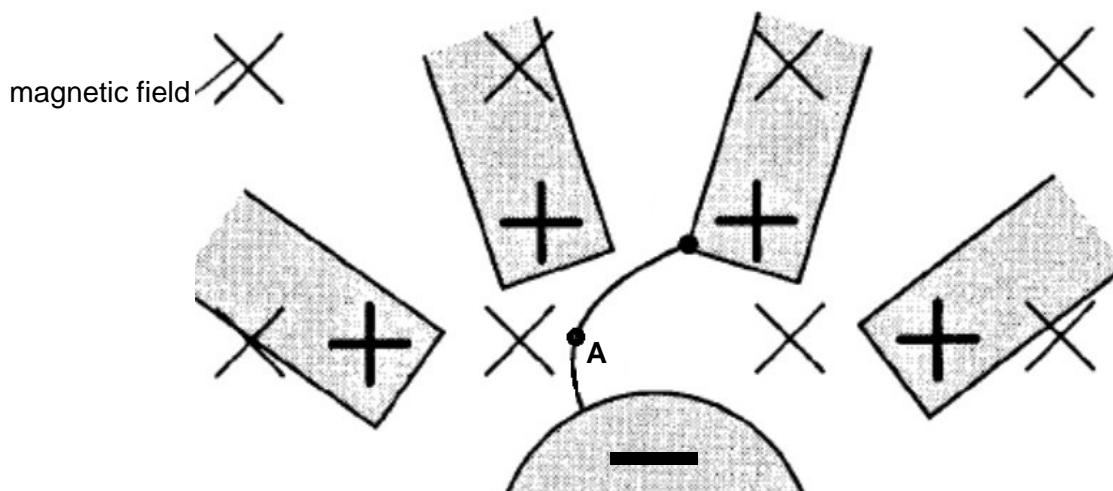

Fig. 7.4

1. On Fig. 7.4, draw and label the forces acting on the electron at A. [2]
2. State and explain how the introduction of the magnetic field will affect the maximum kinetic energy gained by an electron when moving to the anode calculated in (b)(i). [2]

.....

.....

.....



- (c) An experiment is conducted to investigate penetration of microwaves of frequency 2.45 GHz for a sample of potato mash.

Fig. 7.5 shows the readings obtained for the experiment.

depth into food $z / \text{mm}$	intensity of microwaves at depth $z$ $I / \text{A.U.}$	$\ln(I / \text{A.U.})$
0	24	3.18
4	19	2.94
8	15	
12		2.49
16	10	2.30

Note that intensity  $I$  is measured in arbitrary units (A.U.)

**Fig. 7.5**

- (i) Complete Fig. 7.5 for  $z = 8 \text{ mm}$  and  $z = 12 \text{ mm}$ . [1]
- (ii) A graph of  $\ln(I / \text{A.U.})$  with  $(z / \text{mm})$  is shown in Fig. 7.6.

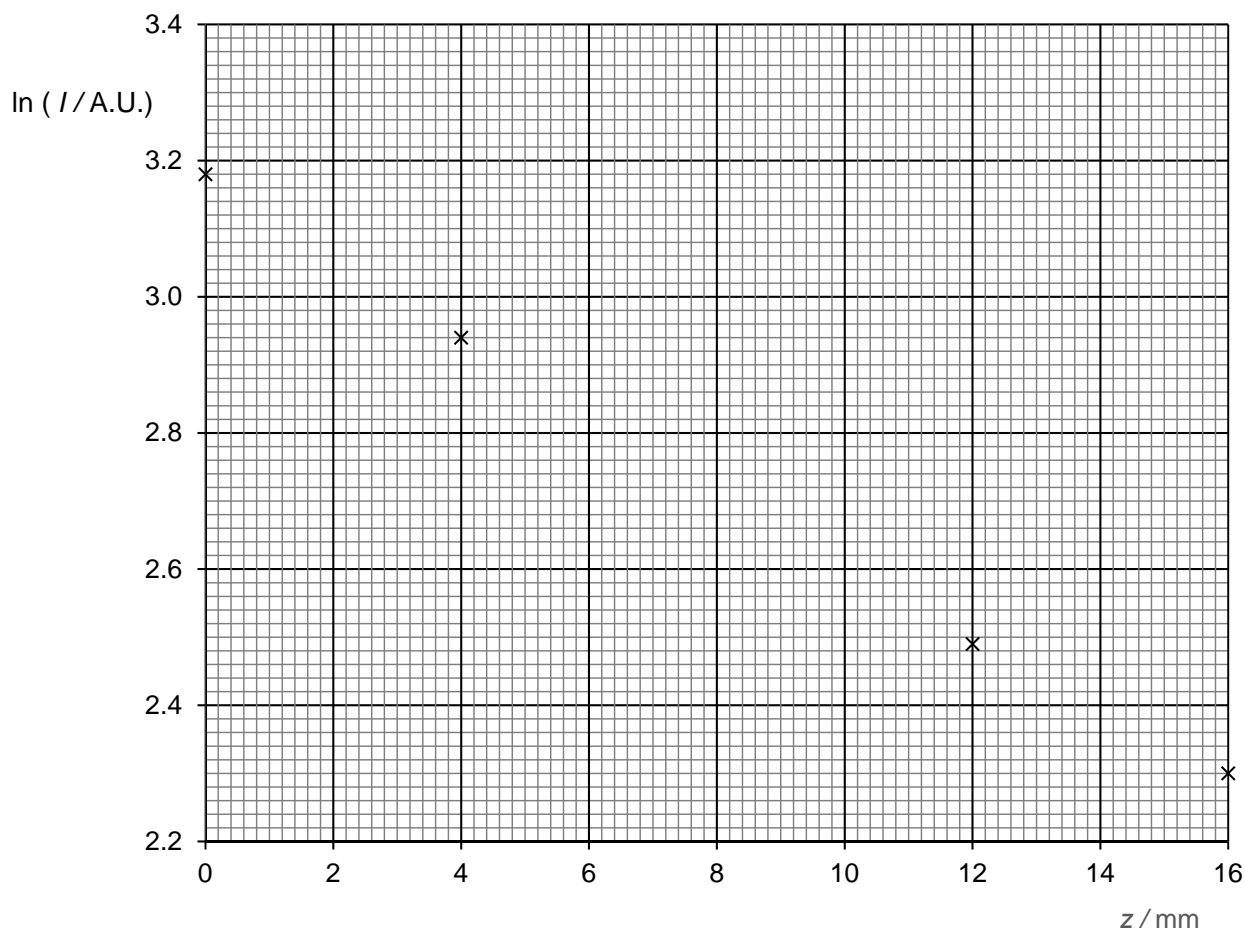

**Fig. 7.6**

- On Fig. 7.6, plot the point corresponding to  $z = 8 \text{ mm}$ .
- Draw the best fit line for all the points. [2]

(iii) Determine the gradient of the line you have drawn.

gradient = ..... [2]

(iv) Hence, determine the penetration depth  $\delta_p$  for the potato mash.

$\delta_p = \dots\dots\dots$ mm [3]

(v) The experiment is then repeated with a potato mash of higher water content.

1. Suggest and explain how the penetration depth will differ from that found in (c)(iv).

.....  
 .....  
 .....

[2]

2. Sketch on Fig. 7.6, the new graph of  $\ln(I/A.U.)$  with  $(z/mm)$  for this experiment. Label this graph **N**.

[1]

**END OF PAPER**

Question	Answer	Marks
1(a)(i)	Loss in gravitational potential energy $\Delta GPE = mg\Delta h = (0.400)(9.81)(0.200) = \mathbf{0.785 \text{ J}}$	1
(a)(ii)	<p><u>Method 1:</u></p> <p>By Newton's second law, taking upwards as positive,</p> $F_{\text{net}} = m a$ $F_{\text{spring}} - W = 0$ $k x = m g$ $k = m g / (0.400 \times 9.81) / (0.200) = \mathbf{19.62 \text{ N m}^{-1}}$ <p>The elastic potential energy stored</p> $\Delta EPE = \frac{1}{2} k x^2 = \frac{1}{2} (19.62) (0.200)^2 = \mathbf{0.392 \text{ J}}$ <p><u>Method 2:</u></p> <p>In equilibrium, the spring force is equal to the weight of the object,</p> $F_{\text{spring}} = W$ $k x = m g$ $k = m g / (0.400 \times 9.81) / (0.200) = \mathbf{19.62 \text{ N m}^{-1}}$ <p>The elastic potential energy stored</p> $\Delta EPE = \frac{1}{2} k x^2 = \frac{1}{2} (19.62) (0.200)^2 = \mathbf{0.392 \text{ J}}$	1    1    1
(b)	<p>The difference is <b>work done against the external force</b> needed to support the mass while lowering it gently. This force is the <b>difference between the mass's weight and the tension in the spring</b>.</p> <p>OR</p> <p>A <b>variable external upward force is required</b> when the spring mass is stretched gently downwards towards its equilibrium point. Thus <b>some gravitational potential energy is lost due to the negative work done by the external force</b>, while the remainder is converted to elastic potential energy.</p>	1 1
(c)(i)	<p>Angular frequency of mass-spring system</p> $\omega = \sqrt{k/m} = \sqrt{\mathbf{19.62/0.400}} = \mathbf{7.00 \text{ rad s}^{-1}}$ <p>Maximum speed <math>v_0 = \omega x_0 = 7.00 \times 0.100 = \mathbf{0.700 \text{ m s}^{-1}}</math></p>	1  1
(c)(ii) & (iii)	<p>Both P and Q are labelled correctly (indicated with a dot or a cross)</p> <p>Correct axes labels of <math>v_{\text{max}}</math> and amplitude.</p> <p>A curve starting at a displacement of -0.100 m and spiralling with smaller <math>v</math> and <math>x</math> in clockwise direction.</p>	1  1 1

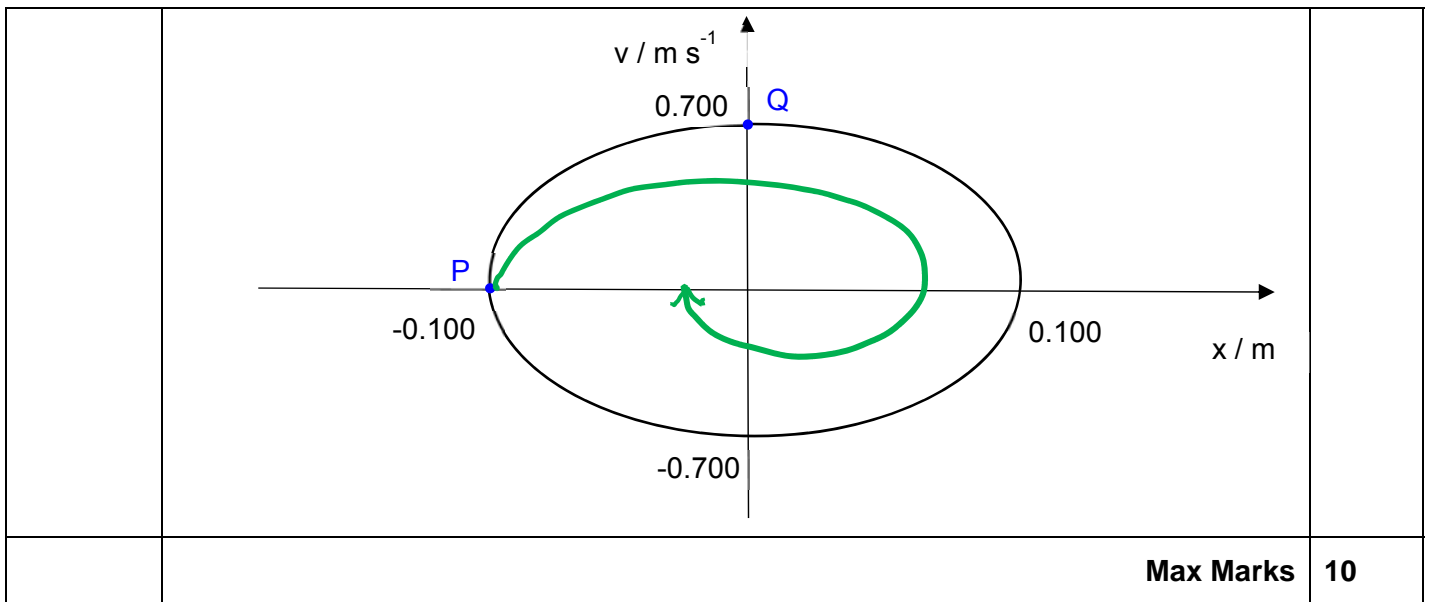

Question	Answer	Marks
2(a)	The <b>total</b> linear momentum of a system is conserved if <b>no net external force</b> acts on the system.	1
2(b)(i)	<div style="text-align: center;"> </div> $T_1 = M_1g = (4.0)(9.81) = 39.2 \text{ N}$ $T_2 = M_2g = (8.0)(9.81) = 78.5 \text{ N}$	1 1
(b)(ii)	<p>Since the disturbance is small and the net force on the system can be taken to be zero, hence total momentum remains at zero throughout.</p> $M_1v_1 + M_2(-v_2) = 0$ $v_2 = \frac{1}{2} v_1$ <p><i>Note that v is defined as speed in this question (i.e. no negative values for v)</i></p>	1 1
(b)(iii)	<p>The disturbance results in the increase of total kinetic energy of the system.</p> $\text{Energy introduced} = \frac{1}{2}(4)(v_1^2) + \frac{1}{2}(8)(v_2^2) = 3v_1^2$	1 1
(b)(iv)	There is no change in kinetic energy when the masses were moving at constant speed.	1

	Lost in GPE per unit time of $M_1 = 4gv_1$ Gain in GPE per unit time of $M_2 = 8gv_2 = 4gv_1$ Hence the total energy remains the same.	1
	<b>Max Marks</b>	<b>9</b>

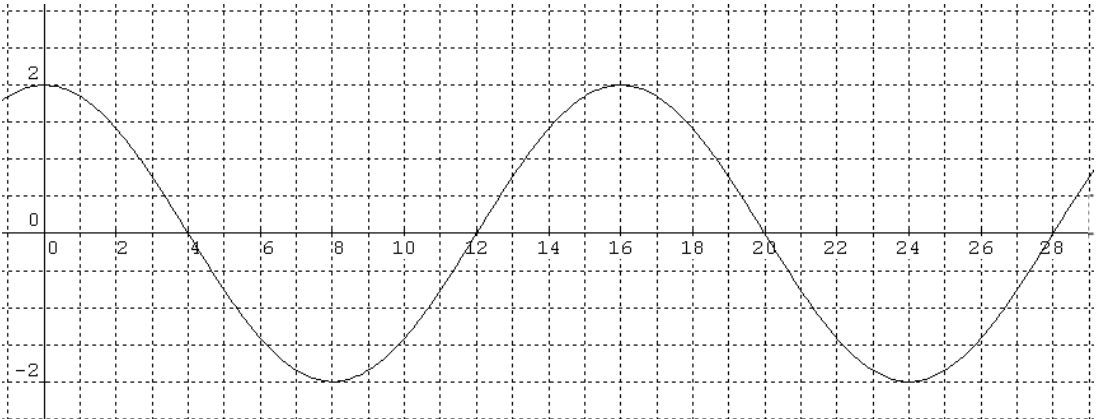
Question	Answer	Marks
3(a)(i)	Using $I = \frac{P}{4\pi r^2}$ $I = \frac{3.826 \times 10^{26}}{4\pi(149.6 \times 10^6 \times 10^3)^2} = 1360.4 \text{ W m}^{-2}$ (at least 4 s.f)	1  1
(a)(ii)	<ul style="list-style-type: none"> <li>• Sun emits light across entire EM spectrum, but the photometer in question detects only visible region</li> <li>• Atmosphere absorbs or reflects some of EM radiation.</li> <li>• Presence of clouds block some of the sunlight.</li> <li>• Angle at which sun's rays strike earth's surface not right angles.</li> </ul>	1
(a)(iii)	$I = \frac{P}{A}$ $P_{max} = I_{max} \cdot A = 1360.4(0.0400) = 54.42 \text{ W}$ (3 s.f)	1  1
(b)(i)	$y = y_o \cos \omega t$ $y = 0.020 \cos\left(\frac{2\pi}{16}\right)t = 0.020 \cos 0.125\pi t = 0.020 \cos 0.393t$  1 mark for correct $\omega$	1  1
(b)(ii)	$\Delta\phi = \frac{x}{\lambda} \times 2\pi = \frac{\lambda/4}{\lambda} \times 2\pi$ $= 0.50 \pi \text{ rad} = 1.57 \text{ rad}$ (no units deduct one mark)	1  1
(b)(iii)	$y / \text{cm}$ 	t / s

	- negative sine graph (correct shape) - with same period of 16 s - smooth and sinusoidal curve (2 marks) Mark by deduction	
	<b>Max mark</b>	<b>11</b>

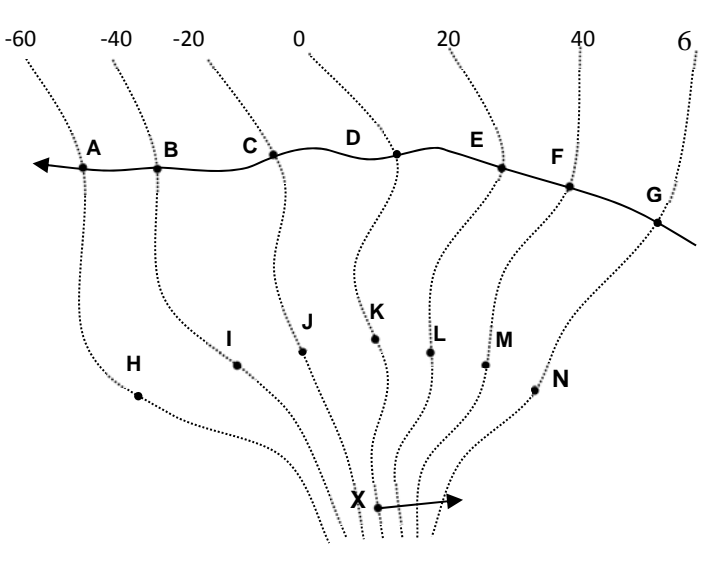
Question	Answer	Marks
4(a)	A region of space where a charged particle will experience an electric force.	1
(b)(i)	<p>Look out for <u>both</u></p> <ol style="list-style-type: none"> <li>field line approximately perpendicular to equipotential lines at the points A, B, C, D, E, F, G.</li> <li>direction of field line. From right to left (higher to lower potential)</li> </ol> 	<p>1</p> <p>1</p>
(b)(ii)	<p>Relative field strength (within the same diagram) is represented by the density of equipotential lines. More/closely spaced equipotential lines represent a stronger field as compared to regions where the equipotential lines are more sparse.</p> <p>Hence the electric field is stronger at X.</p>	1
(b)(iii)	<p>Electric potential energy of <math>-5.0\mu\text{C}</math> at L,</p> $U = Vq = (20)(-5.0 \times 10^{-6}) = -1.0 \times 10^{-4} \text{ J}$	<p>1</p> <p>1</p>
(b)(iv)	<p><b>work required by external force (= - work done by the field) = <math>(V_f - V_i)q</math></b></p> $\Rightarrow -1.0 \times 10^{-4} = (V_f - 20)(-5.0 \times 10^{-6})$ $\Rightarrow V_f = 40 \text{ V}$ <p>Thus, possible points are <b>F &amp; M</b>.</p>	<p>1</p> <p>1</p>
(b)(v)	$F = qE = q \frac{\Delta V}{\Delta x} = (-15.0 \times 10^{-6}) \left( \frac{20 - (-20)}{0.01} \right) = -0.60 \text{ N (1s.f)}$	<p>1</p> <p>1</p>

	(-ve sign indicates $F$ opposite direction to $E$ , which was from right to left. Thus general direction of $F$ towards the right, drawn perpendicular to potential line)	1
	<b>Max marks :</b>	<b>11</b>

Question	Answer	Marks
5(a)(i)	Reading off graph, at 22.5 °C, $R_T = 1600 \Omega$	1
(a)(ii)	Since p.d. across thermistor, $V_{\text{thermistor}} = 2.70 \text{ V} \rightarrow R_T / (R_T + R) \times 9 = 2.70$ $R = 3730 \Omega$	1 1
(b)(i)	Resistance of wire = $\rho L / A = 1.10 \times 10^{-6} \times 1.20 / [\pi \times (0.250 \times 10^{-3})^2]$ $= 6.7227 = 6.72 \Omega$	1 1
(c)(ii)	p.d. across XY, $V_{XY} = [6.7227 / (6.7227 + 1.50 + 6.20)] \times 12.0 = 5.5934 \text{ V}$  At balance point, p.d. across thermistor = p.d. across XJ = 2.70 V Therefore, $XJ = 2.70 / 5.5934 \times 1.2$ $\rightarrow XJ = 0.579 \text{ m}$	1   1
(c)(iii)	When the thermistor is placed at a temperature of 0 °C, the resistance of thermistor increases and hence the <u>potential difference across thermistor will increase</u> . As such, <u>the balance point J will be closer to Y</u> .	1 1
(c)(iv)	When the external resistor becomes smaller in value, by potential divider principle, the <u>potential difference across XY becomes larger</u> . As such, the <u>balance point J will be closer to X</u> .	1 1
	<b>Max Marks</b>	<b>11</b>

Question	Answer	Marks
6(a)(i)	Binding energy is defined as the amount of energy required to separate a nucleus into its individual protons and neutrons or nucleons.	1
6(a)(ii)	At $A=170$ , $BE/A \sim 8.10 \text{ MeV}$ (between 8.10 to 8.30 MeV) BE of ${}^{170}_{77}\text{Ir} = (8.10 \text{ to } 8.30) \times 170 = 1377 \text{ MeV to } 1411 \text{ MeV}$	1
6(a)(iii)	$B.E = \Delta mc^2$ $\Delta m = \frac{BE}{c^2} = \frac{1377 \times 10^6 \times 1.6 \times 10^{-19}}{(1.66 \times 10^{-27})(3 \times 10^8)^2} = 1.475 \text{ u}$ 1377 MeV to 1411 MeV $\rightarrow 1.475 \text{ u to } 1.515 \text{ u}$	1 1

<b>6(b)(i)</b>	<p>Mass Defect = <math>(3 \times 4.002603 - 12.000000) \text{ u}</math></p> <p>Energy released</p> $E = \Delta mc^2$ $= 0.007809 \times 1.66 \times 10^{-27} \times (3.00 \times 10^8)^2$ $= 1.17 \times 10^{-12} \text{ J}$	<p>1</p> <p>1</p>
<b>6(b)(ii)</b>	<p>After this point, after nickel, the <u>total binding energy of the reactants exceeds that of the products</u>, so no net energy would be released after the reaction.</p>	<p>1</p>
<b>Max Marks</b>		<b>7</b>

Question	Answer	Marks
<b>7(a)(i)</b>	<p>To <u>prevent microwaves/(em) radiation</u> from <u>leaking/escaping out/exiting</u> of the cage/microwave oven.</p>	<p>1</p>
<b>(a)(ii)</b>	<p>From the passage, by international convention, wavelength of microwave oven used is given by 2.45 GHz.</p> <p>Wavelength of the microwave = <math>\underline{3.00 \times 10^8 / 2.45 \times 10^9 \text{ Hz} = 0.122 \text{ m}}</math></p> <p>100 times smaller than 0.122 m or 12.2 cm = <math>\underline{1.22 \times 10^{-3} \text{ m}}</math> or 0.0012 m.</p> <p>Value should be less than 0.00122 m but large enough so that food to be cooked can be viewed through the metal grids e.g. 0.001 m.</p> <p>[M1] mark is awarded for using the information of 2.45 GHz for microwave oven.</p> <p>[A1] spacing &lt; 1/100 of the wavelength of the microwave.</p> <p>First M1 mark must be correct before second mark is given.</p> <p>[-1] Powers of Ten error for conversion of GHz</p>	<p>M1</p> <p>A1</p>
<b>(b)(i)</b>	<p>Potential difference across the electrodes = 5000 V</p> <p>By conservation of energy,</p> <p><u>Kinetic energy gained = electrical potential energy loss</u> = <math>(5000)(1.6 \times 10^{-19}) = 8.0 \times 10^{-16} \text{ J}</math></p>	<p>1</p>
<b>(b)(ii)</b>	<p><math>P = (\text{Energy of the electron}) \times (n / t)</math></p> <p>Each electron has available max. <math>8.0 \times 10^{-16} \text{ J}</math> energy (assuming that the electrons start off from cathode with negligible kinetic energy) to be converted to microwave.</p> <p>Least number of electrons per second</p> $= \frac{1000 \text{ W}}{8.0 \times 10^{-16}} = 1.25 \times 10^{18}$ <p>(Allow value calculated from (b)(i))</p> <p><b>Alternative method:</b></p> <p><math>P = IV \Rightarrow I = 1000 / (5.00 \times 10^3) = 0.200 \text{ A}</math></p> <p><math>I = Q/t = (n/t) (1.60 \times 10^{-19}) = 0.200 \text{ A}</math></p>	<p>1</p>

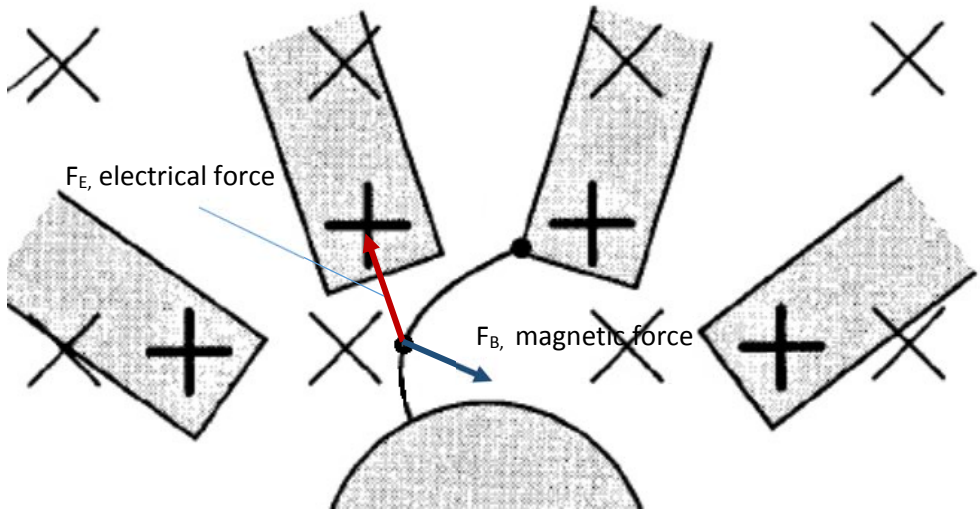

	$n/t = 0.200 / (1.60 \times 10^{-19}) = 1.25 \times 10^{18}$	
<b>b(iii)</b>	<p><u>Not all the (kinetic) energy of the electrons is converted into the <b>energy of the microwaves</b> as :</u></p> <ul style="list-style-type: none"> <li>• Electrons gives off e.m. radiation of varying wavelengths as it accelerates towards the anode and hence actual energy possessed by electrons are lower when reaching the anode.</li> <li>• some electrons hit the anode, some of its kinetic energy is also converted to heat energy / passed to the molecules (or atoms) in the anode causing thermal agitation/ converted to so less energy is available for conversion to microwave energy</li> </ul> <p>Not all the microwaves generated from the energy is fed into the cavity resulting in energy losses due to :</p> <ul style="list-style-type: none"> <li>• the walls in the cavity of the food chamber may absorb some of the microwave,</li> <li>• microwaves may be fed back / coupled back to the magnetron</li> </ul> <p>(resulting in actual useful power of microwave less than the actual energy that can be supplied by the electrons).</p> <p>Answer related must be relate back to the efficiency of <u><b>conversion of energy of the electrons to the power output of the microwave; or lost in microwave produced fed into cavity</b></u></p>	1
<b>(b)(iv)1.</b>	 <p>Correct direction of <math>F_E</math> drawn and labelled. (// to electric field line towards anode, see Fig. 7.3 for the electric field between the anode and cathode.)</p> <p>Correct direction of <math>F_B</math> drawn and labelled. (The velocity of the electron should be tangent to trajectory. Apply Fleming's left hand rule to get direction, towards centre of "circular motion" and perpendicular to trajectory)</p> <p>[-1] if <math>F_E</math> and <math>F_B</math> is not defined.</p> <p>Ignore weight if labelled. (Weight is insignificant to the electrical and magnetic forces)</p>	1 1
<b>(b)(iv)2.</b>	<p>As the <u>magnetic force on the electron is acting perpendicular to its motion</u>, (no work is done by the magnetic force on the electron), hence it does not affect the speed of motion as it moves towards the anode.</p> <p>Hence the <u>maximum kinetic <b>gained</b> remains unchanged.</u></p>	1 1

(c)(i)

depth into food z / mm	intensity of microwaves at depth z I / A.U.	ln (I / A.U.)
0	24	3.18
4	19	2.94
8	15	2.71
12	12	2.49
16	10	2.30

Values computed correctly and should follow the same d.p and s.f. of the relevant column

1

(c)(ii)

- 1.
- 2.

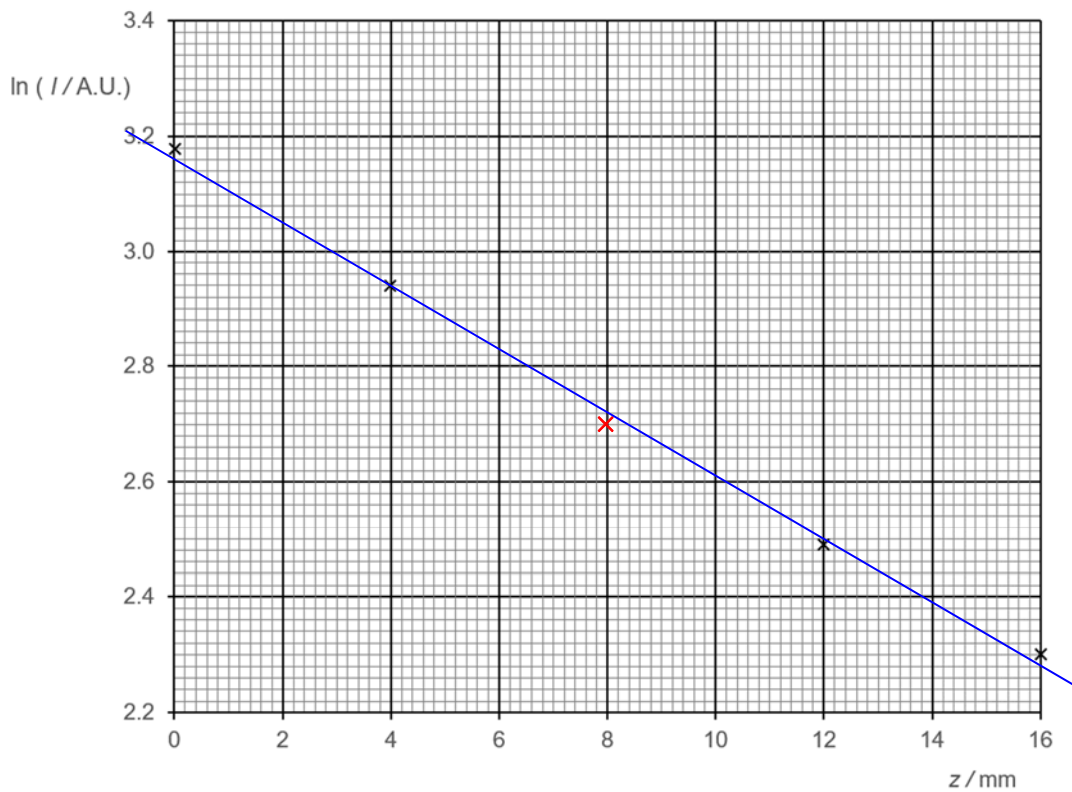

1. Plot the point accurately to the nearest ½ smallest square.
2. Appropriate best fit line drawn.

1

1

(c)(iii)

Correct computation of the gradient with two points on the best fit line.

[-1] if the points are not read to ½ square precision, ½ square off . If more than one square off [0] for whole part.

[-1] if the two points chosen are  $\Delta z \leq 8$  mm ( 4 large squares)

No units are required. However if units are incorrect [-1]

E.g. Using (0, 3.16) and (16, 2.28),

$$\text{Gradient} = \frac{3.16 - 2.28}{0 - 16} = -0.055$$

1

1

(c)(iv)

$I = I_0 e^{-\mu z} \Rightarrow \ln I = \ln I_0 - \mu z$  Hence, gradient of the graph =  $-\mu$

When  $z = \delta_p$ ,  $I = I_0/e$  or  $\ln(I/I_0) = 1/e$  or  $I = 24/e$

1

1

	$\Rightarrow \frac{I_0}{e} = I_0 e^{-\mu \delta_p} \Rightarrow \delta_p = 1/\mu = 1/0.055 = 18.1 \text{ mm}$	1
<b>(c)(v)1.</b>	The potato mash with a higher water content would have <u>more of the microwave (energy) absorbed at the surface/ more microwave absorbed per unit length/per unit volume by the water molecules</u> the microwave moves through the food, (the intensity of the microwaves will then fall to 1/e of its intensity at the surface in a shorter depth). causing the penetration depth to be <u>smaller</u> .	1 1
<b>(c)(v)2.</b>	N – straight line graph with y-intercept unchanged, gradient is steeper. graph must be coherent with conclusion of penetration depth obtained earlier. [This mark is allocated on the page of the graph grids]	1
	<b>Max mark</b>	<b>21</b>



CANDIDATE NAME

CT GROUP

CENTRE NUMBER

INDEX NUMBER

**PHYSICS**

**9749/03**

**Paper 3 Longer Structured Questions**

**19 September 2018**

**2 hours**

Candidates answer on the Question Paper.

No Additional Materials are required.

**INSTRUCTIONS TO CANDIDATES**

Write your **Centre number, index number, name** and **CT class** clearly on all work you hand in.

Write in dark blue or black pen on both sides of the paper.

You may use an HB pencil for any diagrams or graphs.

Do not use staples, paperclips, highlighters, glue or correction fluid.

**Section A**

Answer **all** questions.

**Section B**

Answer **one** question only. **Circle** the question number of the cover page.

You are advised to spend one and a half hours on Section A and half an hour on Section B.

The number of marks is given in brackets [ ] at the end of each question or part question.

You are reminded of the need for good English and clear presentation in your answers.

For Examiner's Use		
SECTION A		
1		10
2		9
3		11
4		11
5		8
6		11
SECTION B		
7		20
8		20
Deductions		
Total		80

Data	Formulae
speed of light in free space, $c = 3.00 \times 10^8 \text{ m s}^{-1}$	uniformly accelerated motion $s = ut + \frac{1}{2} at^2$ $v^2 = u^2 + 2as$
permeability of free space, $\mu_0 = 4\pi \times 10^{-7} \text{ H m}^{-1}$	work done on / by a gas $W = p \Delta V$
permittivity of free space, $\epsilon_0 = 8.85 \times 10^{-12} \text{ F m}^{-1}$ $\approx (1/(36\pi)) \times 10^{-9} \text{ F m}^{-1}$	hydrostatic pressure $p = \rho gh$
elementary charge, $e = 1.60 \times 10^{-19} \text{ C}$	gravitational potential $\phi = -\frac{Gm}{r}$
the Planck constant, $h = 6.63 \times 10^{-34} \text{ J s}$	temperature $T/\text{K} = T/^\circ\text{C} + 273.15$
unified atomic mass constant, $u = 1.66 \times 10^{-27} \text{ kg}$	pressure of an ideal gas $P = \frac{1}{3} \frac{Nm}{V} \langle c^2 \rangle$
rest mass of electron, $m_e = 9.11 \times 10^{-31} \text{ kg}$	mean kinetic energy of a molecule of an ideal gas $E = \frac{3}{2} kT$
rest mass of proton, $m_p = 1.67 \times 10^{-27} \text{ kg}$	displacement of particle in s.h.m. $x = x_0 \sin \omega t$
molar gas constant, $R = 8.31 \text{ J K}^{-1} \text{ mol}^{-1}$	velocity of particle in s.h.m. $v = v_0 \cos \omega t$ $= \pm \omega \sqrt{(x_0^2 - x^2)}$
the Avogadro constant, $N_A = 6.02 \times 10^{23} \text{ mol}^{-1}$	electric current $I = Anvq$
the Boltzmann constant, $k = 1.38 \times 10^{-23} \text{ J K}^{-1}$	resistors in series $R = R_1 + R_2 + \dots$
gravitational constant, $G = 6.67 \times 10^{-11} \text{ N m}^2 \text{ kg}^{-2}$	resistors in parallel $1/R = 1/R_1 + 1/R_2 + \dots$
acceleration of free fall, $g = 9.81 \text{ m s}^{-2}$	electric potential $V = \frac{Q}{4\pi\epsilon_0 r}$
	alternating current / voltage $x = x_0 \sin \omega t$
	magnetic flux density due to a long straight wire $B = \frac{\mu_0 I}{2\pi d}$
	magnetic flux density due to a flat circular coil $B = \frac{\mu_0 NI}{2r}$
	magnetic flux density due to a long solenoid $B = \mu_0 nI$
	radioactive decay $x = x_0 \exp(-\lambda t)$
	decay constant $\lambda = \frac{\ln 2}{t_{\frac{1}{2}}}$

[BLANK PAGE]

## Section A

Answer **all** questions in the spaces provided.

- 1 Fig. 1.1 is a diagram of a human arm lifting an object.

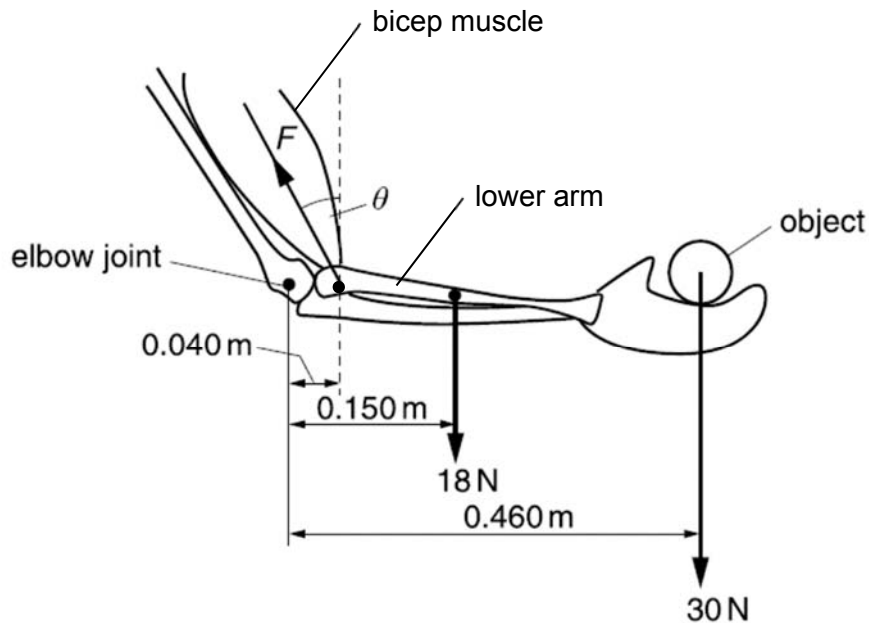

**Fig. 1.1**

The lower arm is horizontal and its centre of gravity is 0.150 m from the elbow joint. The weight of the lower arm is 18 N. The bicep muscle exerts a force  $F$  at an angle of  $\theta$  to the vertical.

The horizontal distance between the elbow joint and the point of attachment of the muscle to the lower arm bone is 0.040 m. The weight of the object held in the hand is 30 N and its centre of gravity is 0.460 m from the elbow joint. The arm is in equilibrium.

- (a) Define *centre of gravity*.

.....  
 .....

[1]

- (b) Determine the value of  $F$  when  $\theta = 15^\circ$ .

$F = \dots\dots\dots$  N [2]

(c) For the lower arm to be in equilibrium, the elbow joint also needs to exert a force  $R$  on the lower arm bone.

(i) Draw a labelled arrow on Fig. 1.1 to represent the force  $R$  that the elbow exerts on the lower arm. [1]

(ii) Explain the direction of this force  $R$ .

.....  
.....  
.....  
.....  
.....  
..... [2]

(d) As the lower arm is slowly moved away from the body in the horizontal direction, the angle  $\theta$  increases.

(i) Sketch in Fig. 1.2 the graph of how  $F$  varies with  $\theta$ . (You may assume that the lower arm remains horizontal and is in equilibrium at all times.)

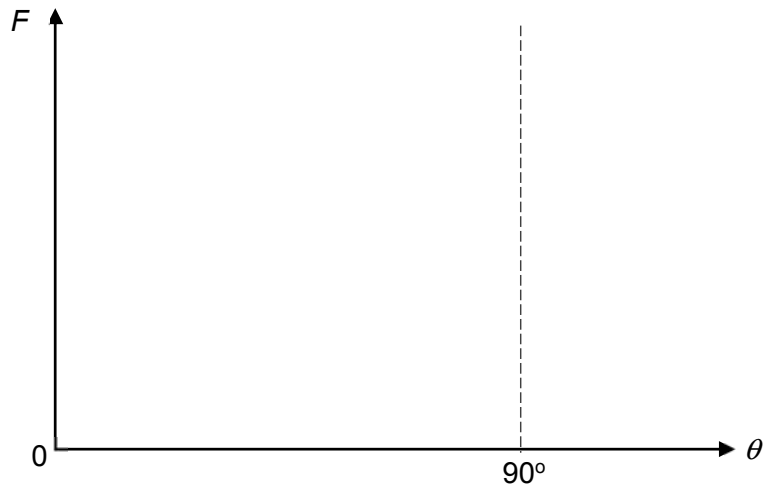

Fig. 1.2 [2]

(ii) Explain the shape of your graph in Fig. 1.2.

.....  
.....  
..... [2]



- 2 (a) Explain what is meant by the internal energy of a system.

.....

.....

..... [2]

- (b) Dry air is enclosed in an air-tight cylinder fitted with a piston, as shown in Fig. 2.1.

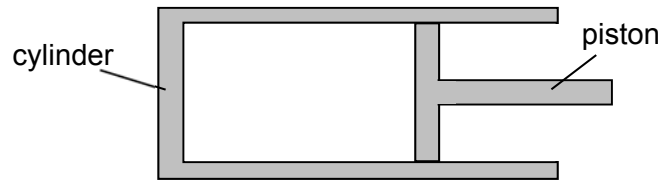

Fig. 2.1

The piston moves to compress the air and the variation with volume  $V$  of the pressure  $p$  of the air during the process from A to B is shown in Fig. 2.2.

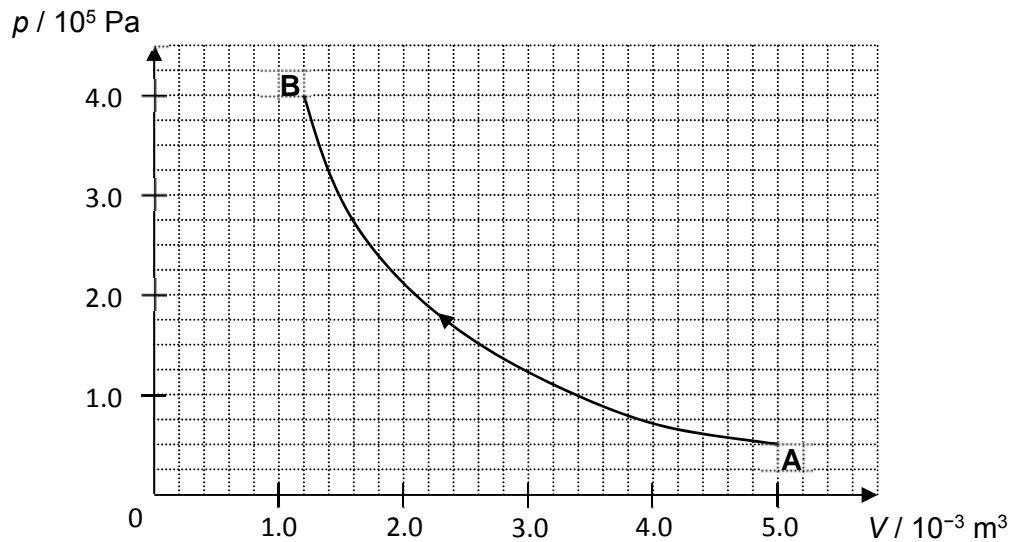

Fig. 2.2

It may be assumed that the dry air behaves as an ideal gas.

- (i) Assume the dry air is a monoatomic gas. Calculate the internal energy of the dry air just before the start of process from A to B.

internal energy = ..... J [2]

(ii) The dry air then goes through two more processes.

Process 2: The air is cooled while keeping the piston at the same position.

Process 3: The air then expands, while kept at constant temperature, to return to its original state.

1. Calculate the pressure of the air at the end of the process 2.

pressure = ..... Pa [2]

2. On Fig. 2.2, draw accurately and label on the  $p$ - $V$  graph of the two processes 2 and 3. [3]

- 3 (a) State the principle of superposition.

.....

.....

.....

.....

[2]

- (b) A source of microwaves is placed on a table at a fixed distance from a detector. A vertical reflecting plate is placed a distance  $y$  from the source and the detector. Reflection at the reflector causes a phase change of  $\pi$  rad to the microwave.

Fig 3.1 shows the **view from above**.

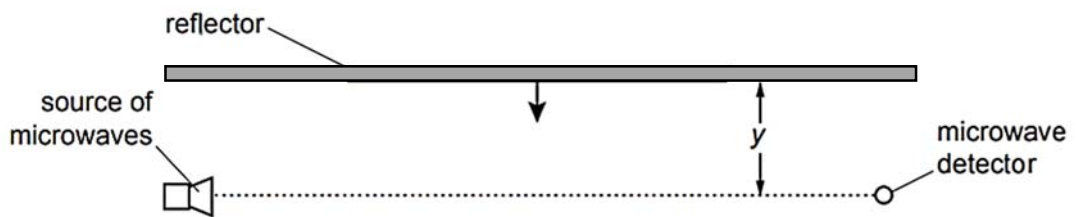

Fig 3.1 (top view)

The reflector is moved gradually towards the source and the detector, in the direction indicated by the arrow on the reflector in Fig 3.1. The intensity measured by the detector alternates between high and low.

Explain these observations.

.....

.....

.....

.....

.....

[3]

- (c) The reflector is fixed at a position  $y = 2.5$  m and the detector is at a distance 5.0 m away. The wavelength of the microwave is 0.59 m.

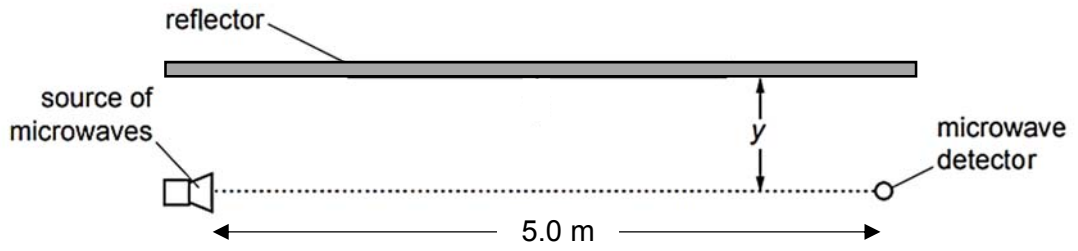

Fig. 3.2

- (i) Explain whether the intensity at the detector is a maximum or a minimum.

.....  
 .....  
 .....  
 .....

[3]

- (ii) Describe how the intensity of reception varies as the detector is moved towards the source along the dotted line until it reaches the source.

.....  
 .....  
 .....  
 .....  
 .....  
 .....

[3]

- 4 This question is about an experiment to estimate the resolution of the human eye.

Two vertical parallel lines are drawn on a piece of card. The separation between the lines  $y$  is  $2.0 \pm 0.5$  mm. The card is fixed to a wall at head level.

A group of students look at the card whilst each covering one eye. They walk back from the card until they can no longer separate the two lines. The distance  $L$  between the eye and the card is measured.

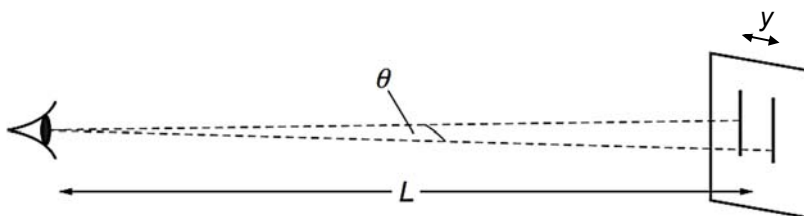

Fig 4.1

Here are the results from the five students:

student	A	B	C	D	E
maximum distance $L$ / m	6.2	5.8	6.1	5.9	6.1

- (a) (i) State the uncertainty of the distance  $L$  based on students' results.

uncertainty = ..... m [1]

- (ii) A student suggests that the uncertainty in the distance  $L$  can be ignored when calculating the minimum angle  $\theta$  that can be resolved because of the uncertainty in the separation of the lines  $y$  on the card.

Comment on this suggestion, explaining whether or not you agree.

.....

.....

.....

.....

.....

.....

.....

[3]

- (iii) Calculate a value for the minimum angle (with its corresponding uncertainty) that can be resolved.

minimum angle that can be resolved = .....  $\pm$  ..... rad [3]

- (b) The diameter of the pupil of the eye is estimated to be 3 mm. The two lines are marked using red ink.

- (i) Explain what is meant by the Rayleigh criterion for the resolution of two patterns.

.....  
 .....  
 .....

[2]

- (ii) Estimate the minimum angle using the Rayleigh criterion.

minimum angle = ..... rad [2]

- 5 (a) Ernest Rutherford proposed a planetary model for the hydrogen atom. In the model, a single electron is treated as a point-like charged particle, moving in circular motion around a stationary proton (the nucleus) as shown in Fig. 5.1.

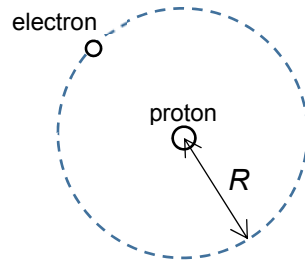

**Fig. 5.1 (not to scale)**

- (i) State two forms of energy that the system possesses and state whether each form is by convention, positive or negative.

..... [2]

.....

- (ii) Explain why the total energy of the system is conventionally taken to be negative when the electron is orbiting the nucleus.

..... [2]

.....

.....

.....

- (b) In quantum mechanics, it is not possible to model the path of the electron in the hydrogen atom to be a well-defined circle around the proton.
- (i) Using Heisenberg uncertainty principle for position and momentum, explain why the path of the electron inside the atom is not well-defined.

.....

.....

.....

..... [2]

- (ii) Despite not knowing the path of the electron, we are certain that the electron remains bound to the nucleus. By considering your answer to (a), show that the maximum kinetic energy of the bound electron is given by  $E_k = \frac{e^2}{4\pi\epsilon_0 R}$ . Explain your working clearly. [2]



- 6 (a) A student writes three incorrect statements as shown in the table below. Each statement has an error either in the unit or number. **Circle** the error in the statement and write the correct answer.

Incorrect statement	Correct number or unit
The weight of a person is about 700 kg.	
The atmospheric pressure at sea level is about $1.0 \times 10^5 \text{ N m}^2$ .	
1 GW is 10 times bigger than 1 MW.	

[3]

- (b) For over a century, the standard kilogram has been defined by a small platinum-iridium cylinder housed at the International Bureau of Weights and Measures in France. This is the last remaining human-made material object on which a measurement standard is based. Suggest why the use of a physical sample as the standard became inadequate with the advancement in Science.

.....

.....

.....

[1]

- (c) It was proposed at the turn of this century that mass be defined in terms of the Planck constant  $h$  rather than in terms of a physical standard mass. This can be done using a watt balance, an electromechanical mass measuring instrument that measures the mass of a test object very precisely by the strength of an electric current and a voltage.

Fig 6.1 shows a simplified version of the watt balance.

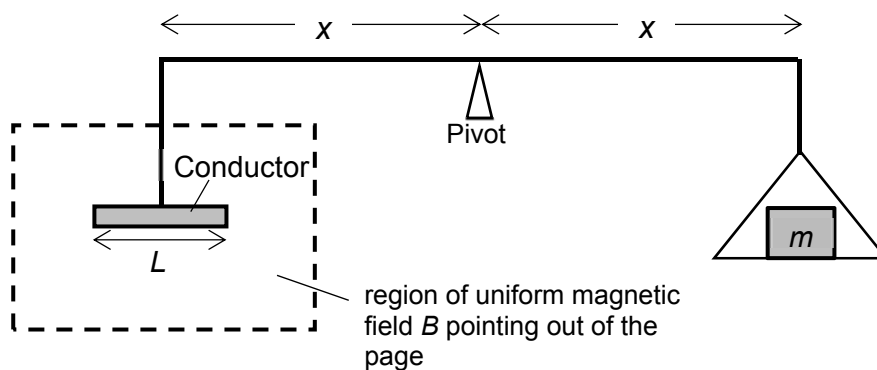

**Fig 6.1**

The mass  $m$  on the right arm of the balance is the mass to be measured. On the left arm, a conductor of length  $L$  is placed in a uniform magnetic field with flux density  $B$  pointing out of the page.

The process of finding  $m$  involves two stages.

- (i) Stage 1: To balance the mass, a constant current  $I$  is passed through the conductor such that a magnetic force is exerted on the conductor. Using the principle of moments, the balancing condition is

$$mgx = BILx$$

where  $g$  is the gravitational field strength and can be treated as a constant.

Indicate the direction of the conventional current through the conductor by drawing an arrow on it in Fig. 6.1. [1]

- (ii) Stage 2: The mass  $m$  is removed from the balance and the conductor is made to travel at a constant speed  $u$  through the same magnetic field as shown in Fig. 6.2.

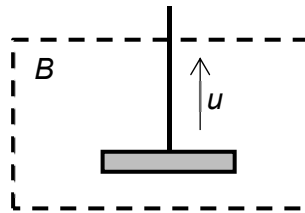

Fig. 6.2

1. Explain how a potential difference is set up across the ends of the conductor.

.....

.....

.....

.....

.....

[2]

2. Hence, show that the potential difference  $V$  set up is given by  $BLu$ .

[2]

- (iii) Very precise and accurate values of  $V$  and  $I$  can be determined using  $V = \frac{hC}{2e}$  and  $I = \frac{kne}{2}$ , where  $e$  is the elementary charge,  $n$  is an integer and  $C$  and  $k$  are known constants.

Using (c)(i) and (ii), show how the mass  $m$  can be defined in terms of the Planck constant  $h$ .

[2]

**Section B**

Answer **one** question from this Section in the space provided.

- 7 (a) State and define the unit for magnetic flux.

.....  
 .....  
 .....

[2]

- (b) The plan view (from top down) of a train braking system is illustrated in Fig 7.1. The train carriage of mass  $m$  is mounted on a rectangular metal frame ABCD of length  $L$  and width  $w$ , the effective resistance of the frame is  $R$ . The train carriage is initially moving at a constant speed along the rails.

A uniform magnetic field  $B$  is directed perpendicularly into the ground over a rectangular region of length  $L$ . Line P denotes the start of this region while line Q denotes the end of the region. After passing through the magnetic field, the train speed is expected to be reduced to a very low speed after which brakes can be applied to stop it completely. You may assume that friction is negligible.

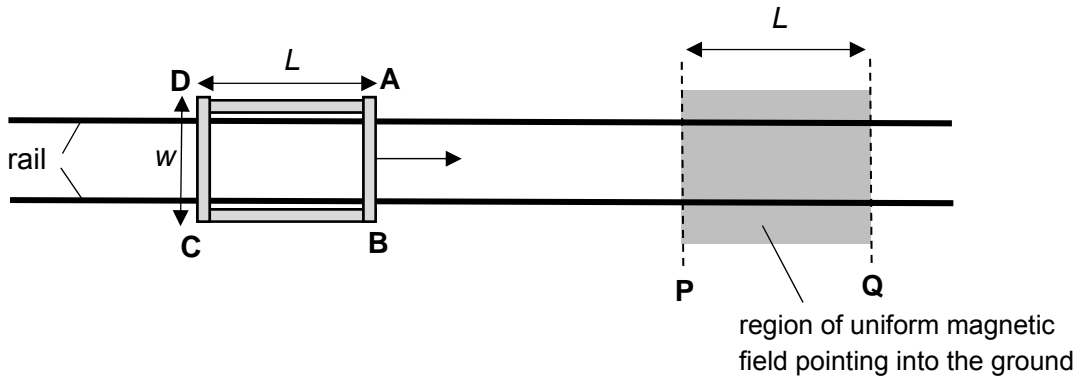

**Fig 7.1 (top view)**

- (i) Explain how the train carriage is slowed as AB moves through the magnetic field from P to Q.

.....  
 .....  
 .....  
 .....  
 .....

[3]

- (ii) Show that the emf induced in the frame  $E$  is given by  $Bwv$  where  $v$  is the speed of the train carriage. Explain your working clearly. [2]

- (iii) Hence, deduce an expression for the magnitude of the acceleration of the train carriage as it moves through the magnetic field in terms of  $B$ ,  $w$ ,  $v$ ,  $m$  and  $R$ .

acceleration = ..... [3]

- (c) The graph in Fig 7.2 shows the velocity of the train carriage as it moves through the magnetic field, from the instant AB crosses line P to the instant CD crosses line Q.

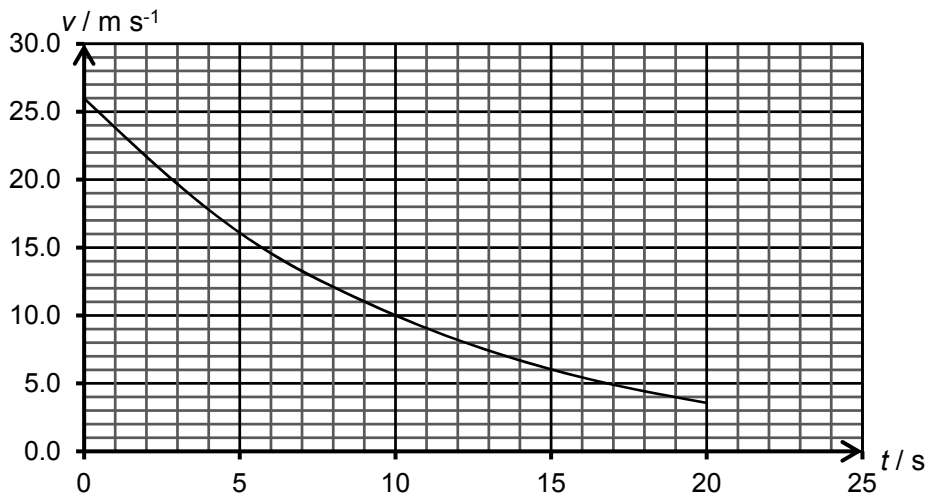

Fig 7.2

(i) Use Fig 7.2 to estimate the distance PQ.

PQ = ..... m [3]

(ii) Comment on how increasing the region of magnetic field (distance between P and Q) would affect the exit speed of the train after passing through it.

.....  
 .....  
 ..... [2]

(iii) Sketch on Fig 7.3 the variation of the velocity of the train carriage as it passes through the magnetic field if distance PQ is now reduced.

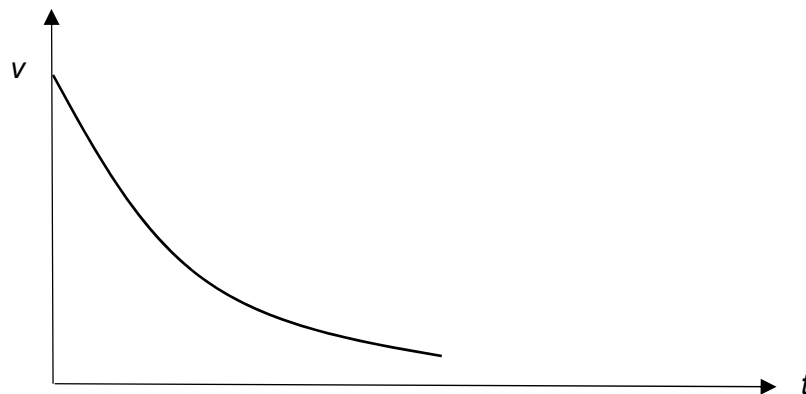

[3]

Fig 7.3

(iv) Suggest and explain one modification that can be incorporated into the train braking system so that in the event of a train malfunction which causes the train to be moving at a speed that is much higher than expected, the system can still slow the train down to an acceptable speed.

.....  
 .....  
 .....  
 ..... [2]

8 (a) State Newton's law of gravitation.

.....  
 .....  
 .....  
 .....

[2]

(b) Earth rotates about its axis with a period of 24 hours. Assume Earth has a uniform density.

Radius of Earth =  $6.37 \times 10^6$  m

Mass of Earth =  $5.97 \times 10^{24}$  kg

(i) Calculate the centripetal acceleration of a man standing at Earth's equator.

centripetal acceleration = ..... m s<sup>-2</sup> [2]

(ii) Hence, calculate the acceleration of free fall at the equator of Earth, and explain why this value may be different from that at the poles.

.....  
 .....  
 .....

[4]

- (c) The International Space Station (ISS) revolves the Earth in a circular orbit at a height of just 408 km above Earth's surface.
- (i) Show that the period of the ISS is 1.5 hours.

[2]

- (ii) For a circular orbit, the radius,  $r$ , and period,  $T$ , are related by the relationship

$$T^2 \propto r^3$$

This result is also known as Kepler's Third Law.

A student noted that a point on Earth's equator rotates with a period of 24 hours but the ISS in (c)(i) orbits with a period of just 1.5 hour.

Comment the apparent discrepancy between the student's observation and Kepler's Third Law.

.....

.....

.....

.....

.....

[2]

- (iii) An astronaut on the ISS deduced that he must be weightless since he was floating. Comment on his deduction.

.....

.....

.....

.....

[2]



- (d) The table shows data relating the Moon orbiting the Earth and an electron orbiting the nucleus of a hydrogen atom.

	Moon orbiting Earth	electron orbiting nucleus
mass / kg	$7 \times 10^{22}$	$9 \times 10^{-31}$
speed / $\text{m s}^{-1}$	$1 \times 10^3$	$2 \times 10^7$
orbital radius / m	$4 \times 10^8$	$5 \times 10^{-11}$

**Fig. 8.1**

- (i) Using the data from Fig 8.1, determine

1. the de Broglie wavelength of the Moon orbiting the Earth,

wavelength = ..... m

2. the de Broglie wavelength of the electron orbiting the nucleus.

wavelength = ..... m [3]

- (ii) Hence, explain why it is reasonable to treat the Moon in orbit around the Earth as a “particle” but it is not reasonable to treat the electron in orbit around the nucleus as a “particle”.

.....

.....

.....

.....

.....

.....

.....

.....

.....

.....

[3]

**END OF PAPER**

Hwa Chong Institution  
2018 C2 Prelim H2 Physics Paper 3 Suggested Solution

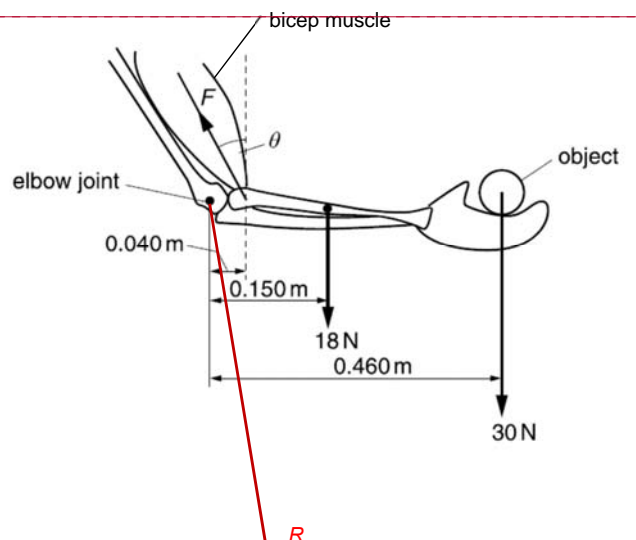
Qn 1	Answer	Marks
(a)	It is the point where the weight appears to act.  Do not accept: "The point where gravity acts" or "point where mass acts/is concentrated"	B1
(b)	Taking moments about the elbow joint, $(F \cos 15.0^\circ)(0.040) = (18)(0.150) + (30)(0.460)$ $(F \cos 15.0^\circ)(0.040) = (18)(0.150) + (30)(0.460)$ $\Rightarrow F = 427 \text{ N}$	M1 A1
(c)(i)		A1
(c)(ii)	'The rightward horizontal component of R is to balance the leftward horizontal component of F.' Taking moments about the point the muscle is attached to the bone, the vertical component of R needs to act downwards to provide an anticlockwise moment to counter the clockwise moment provided by the 18 N and 30 N forces.' OR 'The rightward horizontal component of R is to balance the leftward horizontal component of F.' 'The net vertical force due to the weights and tension is upwards, hence the vertical component of R must act downwards so that there is no net vertical force.' OR 'A vector diagram is drawn in scale.' Using drawn vector diagram in scale, we can deduce the direction of the force R should point rightward/leftward and downward.' OR 'The forces of 18 N/18 N and 30 N/30 N can be combined to form one downwards force which should be drawn between the two mentioned forces.' Since the forces of R, F and combined force due to 18 N/18 N and 30 N/30 N should intersect at a point, we can deduce the direction of the force R should point leftward and downward.'	B1 B1 B1 B1 B1 B1 B1 B1

- Formatted: Complex Script Font: +Body CS (Latha), 11 pt, English (Singapore)
- Formatted ... [1]
- Formatted ... [2]
- Formatted ... [3]
- Formatted ... [4]
- Formatted ... [7]
- Formatted ... [5]
- Formatted ... [6]
- Formatted ... [8]
- Formatted: Complex Script Font: +Body CS (Latha), 11 pt, English (Singapore)
- Formatted ... [9]
- Formatted ... [10]
- Field Code Changed
- Formatted ... [11]
- Formatted: Complex Script Font: +Body CS (Latha), 11 pt, English (Singapore)
- Formatted ... [13]
- Formatted ... [12]
- Formatted ... [14]
- Formatted ... [15]
- Formatted ... [26]
- Formatted ... [16]
- Formatted ... [27]
- Formatted ... [17]
- Formatted ... [28]
- Formatted ... [18]
- Formatted ... [29]
- Formatted ... [19]
- Formatted ... [20]
- Formatted ... [30]
- Formatted ... [21]
- Formatted ... [31]
- Formatted ... [22]
- Formatted ... [23]
- Formatted ... [32]
- Formatted ... [24]
- Formatted ... [33]
- Formatted ... [25]

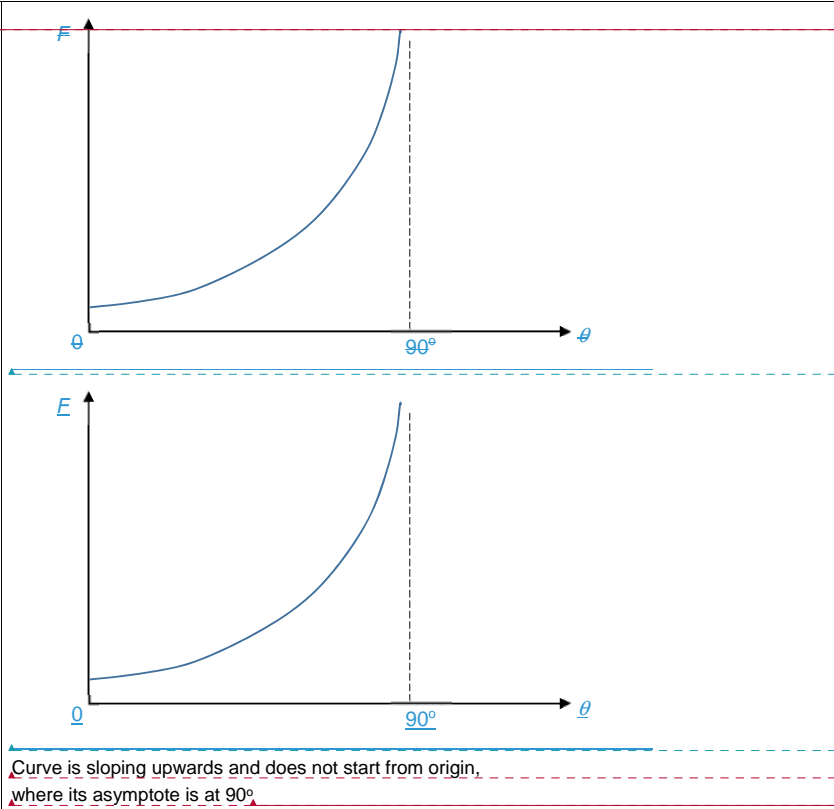
(d)(i)	 <p>Curve is sloping upwards and does not start from origin, where its asymptote is at 90°</p>	
(d)(ii)	<p>Consider moments about the elbow joint.</p> <p>The perpendicular distance between the elbow and the line of action of <math>F</math> decreases or the clockwise moment due to the 18 N and 30 N forces remain the same and <math>F \cos \theta</math> (or vertical component of <math>F</math>) hence remains the constant.</p> <p>Hence, as <math>\theta</math> increase, (<math>\cos \theta</math> reduces), <math>F</math> increases.</p> <p>OR <math>F</math> is inversely proportional to <math>\cos \theta</math>.</p> <p>When <math>\theta</math> approaches 90°, <math>F</math> is infinitely large.</p>	<p>B1</p> <p>B1</p> <p>A1</p> <p>A1</p> <p>Max Marks 10</p>

Question	Answer	Marks
2(a)	<p>The internal energy is the summation of microscopic kinetic energy due to random motion of the molecules and the microscopic potential energy due to intermolecular forces.</p> <p>One mark will be deducted if any one of the four underlined part is missing.</p>	A2
2(b)(i)	$U = \frac{3}{2} nRT$ $U = \frac{3}{2} (PV)$ $U = \frac{3}{2} (0.5 \times 10^5)(5.0 \times 10^{-3})$ $U = 375 \text{ J}$	<p>C1</p> <p>A1</p>

- Formatted [34]
- Formatted: Font: (Default) Arial, 10 pt, Complex Script Font: Arial, 10 pt
- Formatted: Complex Script Font: +Body CS (Latha), 11 pt
- Formatted: Font: (Default) Arial, 10 pt, Complex Script Font: Arial, 10 pt
- Formatted: Complex Script Font: +Body CS (Latha), 11 pt, English (Singapore)
- Formatted: Complex Script Font: +Body CS (Latha), 11 pt
- Formatted [35]
- Formatted [36]
- Formatted [37]
- Formatted [38]
- Formatted [39]
- Formatted [42]
- Formatted [40]
- Formatted: Complex Script Font: +Body CS (Latha), 11 pt
- Formatted: Complex Script Font: +Body CS (Latha), 11 pt, English (Singapore)
- Formatted [41]
- Formatted [43]
- Formatted: Complex Script Font: +Body CS (Latha), 11 pt, English (Singapore)
- Formatted [44]
- Formatted: Complex Script Font: +Body CS (Latha), 11 pt, English (Singapore)
- Formatted [45]
- Formatted [46]
- Formatted [47]
- Formatted [48]
- Formatted [49]
- Formatted [50]
- Formatted [51]
- Formatted: Complex Script Font: +Body CS (Latha), 11 pt
- Formatted [52]
- Formatted [58]
- Formatted: Complex Script Font: +Body CS (Latha), 11 pt
- Formatted [53]
- Formatted [59]
- Formatted [54]
- Formatted [55]
- Formatted [56]
- Formatted [57]

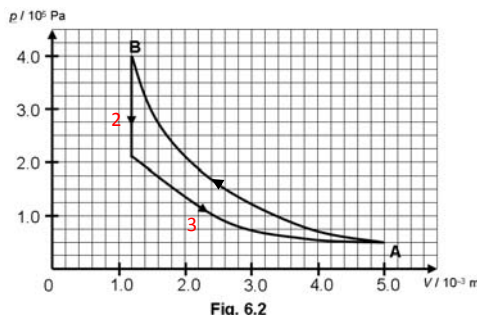
2(b)(ii)	<p>1. Consider process 3          By <math>PV = \text{constant}</math>  <math>(0.5 \times 10^5)(5.0 \times 10^{-3}) = P(1.2 \times 10^{-3})</math>  <math>P = 2.1 \times 10^5 \text{ Pa}</math></p> <p>2.</p>  <p style="text-align: center;">Fig. 6.2</p> <p>Vertical line for process 2          curve for process 3          point of intersection of processes 2 and 3 is at <math>p = 2.1 \times 10^5 \text{ Pa}</math>          processes labelled and arrows included          [mark by deduction]</p>	<p>M1          A1          A3</p> <p style="text-align: right;"><b>Max Marks 9</b></p>
----------	--	--

Question	Answer	Marks
3(a)	When two or more waves of the same kind overlap, the resultant displacement at any point at any instant is given by the vector sum of the individual displacements that each individual wave would cause at that point at that instant.	B2
3(b)	<p>As the reflector moves, the path difference between the direct wave from the source and reflected wave to the detector varies.</p> <p>When the 2 waves meet in antiphase and interfere destructively, the detected intensity is low.</p> <p>When the two waves meet in phase and interfere constructively, the detected intensity is high.</p> <p>Accept for analysis using path difference together with phase change at reflection.</p>	<p>B1          B1          B1</p>
3(c)(i)	<p>path difference = <math>\sqrt{2}(5) - 5 = n(0.59) \Rightarrow n = 3.5</math></p> <p>Since the path difference is odd multiple of half a wavelength and including the phase change due to the reflection,</p> <p>the waves meet in phase/interfere constructively and the detected intensity is a maximum/high.</p>	<p>B1          B1          B1</p>
3(c)(ii)	<p>To determine maximum order: maximum path difference = <math>5 = n(0.59) \Rightarrow n = 8.5</math></p> <p><math>5 = n(0.59) \Rightarrow n = 8.5</math></p> <p>The intensity alternates from maximum to minimum to maximum 5 times.</p>	<p>B1          B1          B1</p>
<b>Max Marks 11</b>		

Question	Answer	Marks
----------	--------	-------

Formatted	[60]
Formatted	[61]
Formatted	[62]
Formatted	[63]
Formatted	[77]
Formatted	[64]
Formatted	[78]
Formatted	[65]
Formatted	[66]
Formatted	[67]
Formatted	[68]
Formatted	[69]
Formatted	[70]
Formatted	[71]
Formatted	[72]
Formatted	[73]
Formatted	[74]
Formatted	[75]
Formatted	[76]
Formatted	[80]
Formatted	[81]
Formatted	[82]
Formatted	[83]
Formatted	[84]
Formatted	[85]
Formatted	[86]
Formatted	[87]
Formatted	[88]
Formatted	[89]
Formatted	[90]
Formatted	[94]
Formatted	[91]
Formatted	[95]
Formatted	[92]
Formatted	[96]
Formatted	[93]
Formatted	[97]
Formatted	[98]
Field Code Changed	[99]
Formatted	[100]
Formatted	[103]
Formatted	[101]
Formatted	[104]
Formatted	[105]
Formatted	[102]
Formatted	[106]
Formatted	[107]
Formatted	[112]
Formatted	[113]
Field Code Changed	[108]
Formatted	[109]
Formatted	[114]
Formatted	[110]
Formatted	[111]
Formatted	[115]
Formatted	[116]
Formatted	[117]

4(a)(i)	$\frac{1}{2}(6.2-5.8) = 0.2 \text{ m}$ $\frac{1}{2}(6.2-5.8) = 0.2 \text{ m}$	A1
4(a)(ii)	<p>Since <math>\theta</math> is small,</p> $\theta = \frac{y}{L}$ $\frac{\Delta\theta}{\theta} = \frac{\Delta y}{y} + \frac{\Delta L}{L} \Rightarrow \theta = \frac{y}{L}$ $\frac{\Delta\theta}{\theta} = \frac{\Delta y}{y} + \frac{\Delta L}{L}$ <p>percentage uncertainty of separation <math>y = \frac{0.5}{2.0} \times 100\% = 25\%</math> <math>\frac{0.5}{2.0} \times 100\% = 25\%</math> or 30% (1 sf)</p> <p>Average <math>L = \frac{6.2+5.8+6.1+5.9+6.1}{5} = 6.0 \text{ m}</math> <math>\frac{6.2+5.8+6.1+5.9+6.1}{5} = 6.0 \text{ m}</math></p> <p>percentage uncertainty of distance <math>L = \frac{0.2}{6.0} \times 100\% = 3\%</math> <math>\frac{0.2}{6.0} \times 100\% = 3\%</math></p> <p>The percentage uncertainty of <math>y</math> is almost 10 times that of <math>L</math>, hence I agree that the uncertainty in <math>L</math> can be ignored.</p>	M1  M1  A1
4(a)(iii)	<p>Since <math>\theta</math> is small,</p> $\theta = \frac{y}{L} = \frac{0.0020}{6.0} = 0.000333 \text{ rad}$ $\theta = \frac{y}{L} = \frac{0.0020}{6.0} = 0.000333 \text{ rad}$ <p><u>Method 1:</u></p> <p>From (c)(ii) the %uncertainty of <math>L</math> can be ignored.</p> $\frac{\Delta\theta}{\theta} = \frac{\Delta y}{y} \Rightarrow \Delta\theta = 0.25 \times 0.000333 = 0.00008 \text{ rad (1 s.f.)}$ $\frac{\Delta\theta}{\theta} = \frac{\Delta y}{y} \Rightarrow \Delta\theta = 0.25 \times 0.000333 = 0.00008 \text{ rad (1 s.f.)}$ <p>Therefore: <math>0.00033 \pm 0.00008 \text{ rad}</math></p> <p><u>Method 2:</u></p> $\theta_{\max} = \frac{y_{\max}}{L_{\min}} = \frac{0.0025}{5.8}$ $\theta_{\min} = \frac{y_{\min}}{L_{\max}} = \frac{0.0015}{6.2}$ $\Delta\theta = \frac{\theta_{\max} - \theta_{\min}}{2} = 0.00009 \text{ rad (1 s.f.)}$ $\theta_{\max} = \frac{y_{\max}}{L_{\min}} = \frac{0.0025}{5.8}$ $\theta_{\min} = \frac{y_{\min}}{L_{\max}} = \frac{0.0015}{6.2}$ $\Delta\theta = \frac{\theta_{\max} - \theta_{\min}}{2} = 0.00009 \text{ rad (1 s.f.)}$ <p>Therefore: <math>0.00033 \pm 0.00009 \text{ rad}</math></p> <p>Accept both cases where uncertainty in <math>L</math> is included and excluded.</p>	B1 B1 A1

- Formatted [121]
- Formatted: Complex Script Font: +Body CS (Latha), 11 pt, English (Singapore)
- Formatted [122]
- Field Code Changed
- Formatted [123]
- Formatted [124]
- Formatted [129]
- Field Code Changed
- Formatted [130]
- Formatted: Complex Script Font: +Body CS (Latha), 11 pt, English (Singapore)
- Field Code Changed
- Formatted: Complex Script Font: +Body CS (Latha), 11 pt
- Field Code Changed
- Formatted [125]
- Formatted: Complex Script Font: +Body CS (Latha), 11 pt
- Field Code Changed
- Formatted [126]
- Formatted [131]
- Formatted [127]
- Formatted [128]
- Formatted [132]
- Formatted [133]
- Formatted [138]
- Formatted [139]
- Formatted [140]
- Field Code Changed
- Formatted [134]
- Formatted [135]
- Field Code Changed
- Formatted [136]
- Formatted [137]
- Field Code Changed
- Formatted: Complex Script Font: +Body CS (Latha), 11 pt
- Formatted: Complex Script Font: +Body CS (Latha), 11 pt, English (Singapore)

4(b)(i)	The first minimum of pattern 1 coincides with the central maximum for pattern 2 for the 2 patterns to be just distinguishable.	B1 B1
4(b)(ii)	$\theta = \frac{\lambda}{b} = \frac{700 \times 10^{-9}}{3 \times 10^{-3}} = 2 \times 10^{-4} \text{ rad}$ $\theta = \frac{\lambda}{b} = \frac{700 \times 10^{-9}}{3 \times 10^{-3}} = 2 \times 10^{-4} \text{ rad}$	C1 A1
	Max Marks	11

Question	Answer	Marks
5(a)(i)	Kinetic energy, KE is positive Electrical potential energy, EPE is negative	A1 A1
5(a)(ii)	Since the electron is orbiting, it means that it is 'confined' to the vicinity of the proton and could not escape on its own.  Hence the magnitude of KE is less than that of EPE. Since the total energy of the system E is the sum of its KE and EPE, E must be a negative number.	B1 B1
5(b)(i)	If the position of the electron at each location is known exactly, by HUP, there is huge uncertainty in its momentum or vice versa. Hence the path cannot be well defined if either the position or momentum are unknown.	M1 A1
5(b)(ii)	The maximum total energy for the system is zero. $TE = EPE + KE = 0$ $KE = -EPE = -\left(\frac{-e^2}{4\pi\epsilon_0 R}\right) = \frac{e^2}{4\pi\epsilon_0 R}$ $KE = -EPE = -\left(\frac{-e^2}{4\pi\epsilon_0 R}\right) = \frac{e^2}{4\pi\epsilon_0 R}$	B1 B1
	Max Marks	8

Question	Answer	Marks
6(a)	circle unit, N circle units, N m <sup>-2</sup> circle 10, 1000	A3
6(b)	The advancement in Science will require better precision at the realm of the very small objects. The physical sample has its associate uncertainty in mass. Any mass measuring instrument calibrated from it will inherit this uncertainty. When that mass measuring instrument is measuring very small masses, the percentage uncertainty in mass will increase with the decreasing mass measured.	A1
6(b)(i)	Using Fleming's left hand rule: left to right	A1
6(b)(ii) 1.	The free electrons in the rod move together with the rod as the rod moves upwards. The electrons experience a magnetic force as they move through the magnetic field. This force causes the electrons to move to one end of the conductor, leaving a net positive charge on the other end, setting up a potential difference between the ends of the conductor.  OR  As the rod moves upwards, it cuts the magnetic flux or the associated magnetic flux linkages changes. By Faraday's law, an e.m.f. emf (that is proportional to the rate of cutting of magnetic flux) will be induced across the two ends of the rod.	B1 B1
6(b)(ii) 2.	At equilibrium, the magnetic force on the charge is balanced by the electric force due to the internal electric field set up at the two ends.	B1

- Formatted ... [141]
- Formatted ... [142]
- Formatted ... [144]
- Formatted ... [143]
- Formatted ... [145]
- Formatted ... [146]
- Field Code Changed ... [147]
- Formatted ... [148]
- Formatted ... [149]
- Formatted ... [150]
- Formatted ... [151]
- Formatted ... [152]
- Formatted ... [153]
- Formatted ... [154]
- Formatted ... [155]
- Formatted ... [156]
- Formatted ... [157]
- Formatted ... [158]
- Formatted ... [160]
- Formatted ... [159]
- Formatted ... [161]
- Formatted ... [162]
- Formatted ... [163]
- Formatted ... [165]
- Formatted ... [164]
- Formatted ... [166]
- Formatted ... [167]
- Formatted ... [168]
- Formatted ... [170]
- Formatted ... [169]
- Formatted ... [171]
- Formatted ... [172]
- Formatted ... [173]
- Formatted ... [174]
- Formatted ... [177]
- Field Code Changed ... [175]
- Formatted ... [176]
- Formatted ... [178]
- Formatted ... [179]
- Formatted ... [180]
- Formatted ... [181]
- Formatted ... [182]
- Formatted ... [183]
- Formatted ... [184]
- Formatted ... [185]
- Formatted ... [186]
- Formatted ... [189]
- Formatted ... [187]
- Formatted ... [188]
- Formatted ... [191]
- Formatted ... [190]
- Formatted ... [192]
- Formatted ... [193]
- Formatted ... [194]
- Formatted ... [195]
- Formatted ... [196]
- Formatted ... [197]
- Formatted ... [202]

	$F_b = F_e \quad F_b = F_e$ $Beu = eE = e \frac{V}{L} \quad Beu = eE = e \frac{V}{L}$ $V = BLu \quad V = BLu$ <p>OR</p> $V = \frac{d\Phi}{dt} = \frac{d(BLx)}{dt} = BLu \quad V = \frac{d\Phi}{dt} = \frac{d(BLx)}{dt} = BLu$ <p>where x is the change in position of conductor in time dt.</p>	B1
6(b)(iii)	$m = \frac{BIL}{g} \quad \text{[from (c)(i)]} \quad m = \frac{BIL}{g} \quad \text{[from (c)(i)]}$ $= \frac{VIL}{Lug} \quad \text{[substitute B using (c)(ii)]} \quad = \frac{VIL}{Lug} \quad \text{[substitute B using (c)(ii)]}$ $= \frac{hC \times kne}{2e \times \frac{1}{2} ug} \quad = \frac{hC \times kne}{2e \times \frac{1}{2} ug}$ $= \frac{nCk}{4ug} h \quad = \frac{nCk}{4ug} h$	B1 A1
	Max Marks	11

Question	Answer	Marks
7a	There is a magnetic flux of 1 weber through a surface if a magnetic field of flux density of 1T exists perpendicularly to an area of 1 m <sup>2</sup> .	B1
7bi	As AB moves from P towards Q, magnetic flux linkage over the area ABCD enclosed by the frame increases resulting in an induced e.m.f. generated in the frame. By Lenz's Law, an induced current flows in the anticlockwise direction. This results in a magnetic force that acts on AB towards the left.  Alternative: As AB enters the magnetic field, magnetic force acts on the electrons in AB driving them in a clockwise direction around the rectangular frame. The induced current flowing anti-clockwise in the frame results in a magnetic force that acts on AB towards the left.	B1 B1 B1
7bii	The magnetic flux (linkage) is given by $\Phi = BA = B(wx)$ where x is the distance AB has moved past P. Hence the induced emf is given by $E = \frac{d\Phi}{dt} = Bw \frac{dx}{dt} = Bwv$	B1 B1
7biii	Induced current is thus $I = \frac{Bwv}{R}$ The braking force that acts on AB is thus $F = -BIw = -\frac{B^2 w^2 v}{R}$ And the acceleration given by $a = \frac{F}{m} = -\frac{B^2 w^2 v}{mR}$ OR applying $P = Fv$	B1 B1 B1
7ci	Distance $2L = \text{Area under } v-t \text{ graph}$ $= \frac{1}{2} (26 + 16 \times 2 + 10 \times 2 + 6 \times 2 + 3.5)(5)$ $= 233.75 \text{ m}$ Range (211, 257) m	B1 B1

Field Code Changed	... [207]
Formatted	... [208]
Formatted	... [212]
Formatted	... [209]
Field Code Changed	... [210]
Formatted	... [211]
Formatted	... [213]
Field Code Changed	... [214]
Formatted	... [215]
Formatted	... [216]
Formatted	... [217]
Formatted	... [218]
Formatted	... [219]
Formatted	... [220]
Formatted	... [221]
Formatted	... [222]
Formatted	... [223]
Formatted	... [224]
Formatted	... [225]
Formatted	... [228]
Formatted	... [226]
Formatted	... [227]
Formatted	... [229]
Formatted	... [230]
Formatted	... [231]
Formatted	... [238]
Formatted	... [232]
Formatted	... [239]
Formatted	... [233]
Formatted	... [240]
Formatted	... [234]
Formatted	... [235]
Formatted	... [241]
Formatted	... [242]
Formatted	... [236]
Formatted	... [243]
Formatted	... [237]
Formatted	... [244]
Formatted	... [245]
Formatted	... [246]
Formatted	... [249]
Formatted	... [247]
Formatted	... [248]
Formatted	... [250]
Formatted	... [251]
Formatted	... [252]
Formatted	... [253]
Formatted	... [259]
Formatted	... [254]
Formatted	... [255]
Formatted	... [260]
Formatted	... [256]
Formatted	... [257]
Formatted	... [261]
Formatted	... [258]
Formatted	... [262]
Formatted	... [263]
Formatted	... [267]



	$PQ = L = 116.9 \text{ m}$	A1
7cii	The retarding force only acts on the train when there is a changing magnetic flux through the frame. There is no force on the train when the whole frame is within the magnetic field. Increasing the length PQ does not change the exit speed.	M1 A1
7ciii	<p>Same slope [B1], plateau [B1], takes a shorter time to pass through the field, higher speed as it leaves the magnetic field [B1]</p>	
7civ	To include <b>multiple regions of magnetic field</b> that can be activated individually when malfunction occurs. Use of electromagnet to generate the magnetic field so that the field can be strengthened by <b>increasing the current in the electromagnet</b> when malfunction occurs. Do not accept any modifications that relate to the dimensions of the train carriage as it is not possible to vary these during a malfunction.	A1 A1
	<b>Max Marks</b>	<b>20</b>

Question	Answer	Marks
8(a)	Every particle attracts every other particle with a force that is directly proportional to the product of their masses and inversely proportional to the square of the distance between them.	A2
(b)(i)	$a_c = r\omega^2$ $a_c = r\omega^2$ $a_c = (6.37 \times 10^6) \left( \frac{2\pi}{24 \times 60^2} \right)^2$ $a_c = (6.37 \times 10^6) \left( \frac{2\pi}{24 \times 60^2} \right)^2$ $a_c = 0.0337 \text{ m s}^{-2}$ $a_c = 0.0337 \text{ m s}^{-2}$	C1 A1
(b)(ii)	$g = \frac{GM}{r^2} = \frac{6.67 \times 10^{-11} (6.0 \times 10^{24})}{(6.37 \times 10^6)^2} = 9.863 \text{ m s}^{-2}$ $a_{\text{freefall}} = g - a_c$ $a_{\text{freefall}} = 9.863 - 0.0337$ $a_{\text{freefall}} = 9.83 \text{ m s}^{-2}$ $g = \frac{GM}{r^2} = \frac{6.67 \times 10^{-11} (6.0 \times 10^{24})}{(6.37 \times 10^6)^2} = 9.863 \text{ m s}^{-2}$ $a_{\text{freefall}} = g - a_c$ $a_{\text{freefall}} = 9.863 - 0.0337$ $a_{\text{freefall}} = 9.83 \text{ m s}^{-2}$	B1 A1 A1 A1

- Formatted ... [269]
- Formatted ... [270]
- Formatted ... [271]
- Formatted ... [272]
- Formatted ... [274]
- Formatted ... [273]
- Formatted ... [275]
- Formatted ... [276]
- Formatted: Complex Script Font: +Body CS (Latha), 11 pt, English (Singapore)
- Formatted: Complex Script Font: +Body CS (Latha), 11 pt, English (Singapore)
- Formatted ... [277]
- Formatted ... [278]
- Formatted ... [279]
- Formatted ... [280]
- Formatted ... [281]
- Formatted ... [284]
- Formatted ... [285]
- Formatted ... [282]
- Formatted ... [283]
- Formatted: Complex Script Font: +Body CS (Latha), 11 pt, English (Singapore)
- Formatted ... [286]
- Formatted ... [287]
- Formatted ... [288]
- Formatted ... [289]
- Formatted ... [290]
- Formatted ... [291]
- Formatted ... [292]
- Formatted ... [293]
- Formatted ... [294]
- Field Code Changed
- Formatted: Complex Script Font: +Body CS (Latha), English (Singapore)
- Formatted ... [295]
- Formatted ... [296]
- Formatted ... [297]
- Formatted ... [298]
- Formatted ... [299]
- Field Code Changed
- Formatted ... [300]
- Field Code Changed
- Formatted ... [301]
- Formatted: Complex Script Font: +Body CS (Latha), English (Singapore)



	A small fraction of the gravitational force acted by the earth on any body near the equator is to provide for the centripetal acceleration; at the pole, the centripetal acceleration is zero and the acceleration of free-fall is entirely due to the pull of earth.	
(c)(i)	Gravitational force provides for centripetal force: $\frac{GM_e m}{r^2} = mr \left(\frac{2\pi}{T}\right)^2$ $T^2 = \frac{4\pi^2 (6.37 \times 10^6 + 408 \times 10^3)^3}{(6.67 \times 10^{-11})(6.0 \times 10^{24})}$ $T = 5542 \text{ s}$ $T = \frac{5542}{3600} = 1.5 \text{ hr (shown)}$ Gravitational force provides for centripetal force: $\frac{GM_e m}{r^2} = mr \left(\frac{2\pi}{T}\right)^2$ $T^2 = \frac{4\pi^2 (6.37 \times 10^6 + 408 \times 10^3)^3}{(6.67 \times 10^{-11})(5.97 \times 10^{24})}$ $T = 5556 \text{ s}$ $T = \frac{5556}{3600} = 1.5 \text{ hr (shown)}$ First mark for formulation of relationship Second mark for correct substitution of values and the calculation of the period in seconds.	M1  M1
(c)(ii)	The Kepler's Law holds for scenarios where the gravitational force provides entirely for the centripetal force hence it holds for the satellite in orbit. However, for student on Earth's surface, there are other forces acting on him (normal contact, etc) and the resultant (centripetal) force is not the gravitational force.	A1  A1
(c)(iii)	Both astronaut and space station are undergoing circular motion and have the same centripetal acceleration provided by their weights. There is no contact force acting on him by his surrounding and hence he perceived himself to be weightless.  Alternative: if a clear account of what true weightlessness mean and how the fact that gravity must have provided the centripetal acceleration, one mark will be awarded.	B1  B1
(d)(i)	1. $\lambda = \frac{h}{mv} = \frac{6.63 \times 10^{-34}}{(7 \times 10^{22})(1 \times 10^3)} = 9.5 \times 10^{-60} \text{ m}$ $\lambda = \frac{h}{mv} = \frac{6.63 \times 10^{-34}}{(7 \times 10^{22})(1 \times 10^3)} = 9.5 \times 10^{-60} \text{ m}$ 2. $\lambda = \frac{h}{mv} = \frac{6.63 \times 10^{-34}}{(9 \times 10^{-31})(2 \times 10^7)} = 3.7 \times 10^{-11} \text{ m}$ $\lambda = \frac{h}{mv} = \frac{6.63 \times 10^{-34}}{(9 \times 10^{-31})(2 \times 10^7)} = 3.7 \times 10^{-11} \text{ m}$ Both correct – 3 marks One correct – 2 marks Method and substitution correct but answers wrong – 1 mark	B1 A1  A1

Formatted ... [302]

Formatted ... [303]

Formatted ... [304]

Formatted ... [308]

Formatted ... [309]

Formatted ... [305]

Field Code Changed

Formatted ... [306]

Formatted ... [307]

Formatted ... [310]

Formatted ... [311]

Formatted ... [313]

Formatted ... [312]

Formatted ... [314]

Formatted ... [315]

Formatted ... [316]

Formatted ... [319]

Formatted ... [317]

Formatted ... [320]

Formatted ... [318]

Formatted ... [321]

Formatted: Complex Script Font: +Body CS (Latha)

Formatted ... [323]

Formatted ... [324]

Field Code Changed

Formatted ... [322]

Formatted ... [325]

Formatted: Complex Script Font: +Body CS (Latha), English (Singapore)

<b>(d)(ii)</b>	For the Moon, its de Broglie's wavelength is very much smaller than the orbital radius.	<b>B1</b>
	For the electron, its de Broglie's wavelength is comparable to its orbital radius.	<b>B1</b>
	Thus the wave-like properties for electron cannot be neglected for its motion around the nucleus while that of Moon can be neglected.	<b>B1</b>
<b>Max Marks</b>		<b>20</b>

Formatted: Complex Script Font: +Body CS (Latha)

Formatted: Complex Script Font: +Body CS (Latha), English (Singapore)

Formatted: Complex Script Font: +Body CS (Latha)

Formatted: Complex Script Font: +Body CS (Latha)

Formatted: Complex Script Font: +Body CS (Latha), English (Singapore)

Formatted: Complex Script Font: +Body CS (Latha), English (Singapore)

Formatted: Complex Script Font: +Body CS (Latha)

Formatted: Complex Script Font: +Body CS (Latha), English (Singapore)

Formatted: Complex Script Font: +Body CS (Latha)

Formatted: Complex Script Font: +Body CS (Latha), English (Singapore)

Formatted: Complex Script Font: +Body CS (Latha)

Formatted: Complex Script Font: +Body CS (Latha), English (Singapore)

Formatted: Complex Script Font: +Body CS (Latha), English (Singapore)

Formatted: Complex Script Font: +Body CS (Latha), English (Singapore)

Formatted: Complex Script Font: +Body CS (Latha), English (Singapore)

Formatted: Complex Script Font: +Body CS (Latha), English (Singapore)

Formatted: Complex Script Font: +Body CS (Latha), English (Singapore)

Formatted: Complex Script Font: +Body CS (Latha), English (Singapore)

**Page 1: [1] Formatted** **Dave Lommen** **24/09/2018 10:00:00 AM**

Complex Script Font: +Body CS (Latha), 11 pt

**Page 1: [1] Formatted** **Dave Lommen** **24/09/2018 10:00:00 AM**

Complex Script Font: +Body CS (Latha), 11 pt

**Page 1: [2] Formatted** **Dave Lommen** **24/09/2018 10:00:00 AM**

Complex Script Font: +Body CS (Latha), 11 pt

**Page 1: [2] Formatted** **Dave Lommen** **24/09/2018 10:00:00 AM**

Complex Script Font: +Body CS (Latha), 11 pt

**Page 1: [3] Formatted** **Dave Lommen** **24/09/2018 10:00:00 AM**

Complex Script Font: +Body CS (Latha), 11 pt

**Page 1: [3] Formatted** **Dave Lommen** **24/09/2018 10:00:00 AM**

Complex Script Font: +Body CS (Latha), 11 pt

**Page 1: [4] Formatted** **Dave Lommen** **24/09/2018 10:00:00 AM**

Font: (Asian) +Body (Calibri), Complex Script Font: +Body CS (Latha), 11 pt

**Page 1: [4] Formatted** **Dave Lommen** **24/09/2018 10:00:00 AM**

Font: (Asian) +Body (Calibri), Complex Script Font: +Body CS (Latha), 11 pt

**Page 1: [5] Formatted** **Dave Lommen** **24/09/2018 10:00:00 AM**

Font: (Asian) +Body (Calibri), Complex Script Font: +Body CS (Latha), 11 pt

**Page 1: [5] Formatted** **Dave Lommen** **24/09/2018 10:00:00 AM**

Font: (Asian) +Body (Calibri), Complex Script Font: +Body CS (Latha), 11 pt

**Page 1: [6] Formatted** **Dave Lommen** **24/09/2018 10:00:00 AM**

Font: (Asian) +Body (Calibri), Complex Script Font: +Body CS (Latha), 11 pt

**Page 1: [6] Formatted** **Dave Lommen** **24/09/2018 10:00:00 AM**

Font: (Asian) +Body (Calibri), Complex Script Font: +Body CS (Latha), 11 pt

**Page 1: [7] Formatted** **Dave Lommen** **24/09/2018 10:00:00 AM**

Complex Script Font: +Body CS (Latha), 11 pt

**Page 1: [7] Formatted** **Dave Lommen** **24/09/2018 10:00:00 AM**

Complex Script Font: +Body CS (Latha), 11 pt

**Page 1: [8] Formatted** **Dave Lommen** **24/09/2018 10:00:00 AM**

Complex Script Font: +Body CS (Latha), 11 pt

**Page 1: [8] Formatted** **Dave Lommen** **24/09/2018 10:00:00 AM**

Complex Script Font: +Body CS (Latha), 11 pt

**Page 1: [9] Formatted** **Dave Lommen** **24/09/2018 10:00:00 AM**

Complex Script Font: +Body CS (Latha), 11 pt

**Page 1: [9] Formatted** **Dave Lommen** **24/09/2018 10:00:00 AM**

Complex Script Font: +Body CS (Latha), 11 pt

**Page 1: [10] Formatted** **Dave Lommen** **24/09/2018 10:00:00 AM**

Complex Script Font: +Body CS (Latha), 11 pt

**Page 1: [10] Formatted** **Dave Lommen** **24/09/2018 10:00:00 AM**

Complex Script Font: +Body CS (Latha), 11 pt

**Page 1: [11] Formatted** **Dave Lommen** **24/09/2018 10:00:00 AM**

Complex Script Font: +Body CS (Latha), 11 pt

**Page 1: [11] Formatted** **Dave Lommen** **24/09/2018 10:00:00 AM**

Complex Script Font: +Body CS (Latha), 11 pt

**Page 1: [12] Formatted** **Dave Lommen** **24/09/2018 10:00:00 AM**

Complex Script Font: +Body CS (Latha), 11 pt

**Page 1: [12] Formatted** **Dave Lommen** **24/09/2018 10:00:00 AM**

Complex Script Font: +Body CS (Latha), 11 pt

**Page 1: [12] Formatted** **Dave Lommen** **24/09/2018 10:00:00 AM**

Complex Script Font: +Body CS (Latha), 11 pt

**Page 1: [13] Formatted** **Dave Lommen** **24/09/2018 10:00:00 AM**

Complex Script Font: +Body CS (Latha), 11 pt

**Page 1: [13] Formatted** **Dave Lommen** **24/09/2018 10:00:00 AM**

Complex Script Font: +Body CS (Latha), 11 pt

**Page 1: [14] Formatted** **Dave Lommen** **24/09/2018 10:00:00 AM**

Complex Script Font: +Body CS (Latha), 11 pt

**Page 1: [14] Formatted** **Dave Lommen** **24/09/2018 10:00:00 AM**

Complex Script Font: +Body CS (Latha), 11 pt

**Page 1: [15] Formatted** **Dave Lommen** **24/09/2018 10:00:00 AM**

Complex Script Font: +Body CS (Latha), 11 pt

**Page 1: [15] Formatted** **Dave Lommen** **24/09/2018 10:00:00 AM**

Complex Script Font: +Body CS (Latha), 11 pt

**Page 1: [16] Formatted** **Dave Lommen** **24/09/2018 10:00:00 AM**

Complex Script Font: +Body CS (Latha), 11 pt

**Page 1: [16] Formatted** **Dave Lommen** **24/09/2018 10:00:00 AM**

Complex Script Font: +Body CS (Latha), 11 pt

**Page 1: [17] Formatted** **Dave Lommen** **24/09/2018 10:00:00 AM**

Complex Script Font: +Body CS (Latha), 11 pt

**Page 1: [17] Formatted** **Dave Lommen** **24/09/2018 10:00:00 AM**

Complex Script Font: +Body CS (Latha), 11 pt

**Page 1: [18] Formatted** **Dave Lommen** **24/09/2018 10:00:00 AM**

Complex Script Font: +Body CS (Latha), 11 pt

**Page 1: [18] Formatted** **Dave Lommen** **24/09/2018 10:00:00 AM**

Complex Script Font: +Body CS (Latha), 11 pt

**Page 1: [19] Formatted** **Dave Lommen** **24/09/2018 10:00:00 AM**

Complex Script Font: +Body CS (Latha), 11 pt

**Page 1: [19] Formatted** **Dave Lommen** **24/09/2018 10:00:00 AM**

Complex Script Font: +Body CS (Latha), 11 pt

**Page 1: [19] Formatted** **Dave Lommen** **24/09/2018 10:00:00 AM**

Complex Script Font: +Body CS (Latha), 11 pt

**Page 1: [20] Formatted** **Dave Lommen** **24/09/2018 10:00:00 AM**

Complex Script Font: +Body CS (Latha), 11 pt

**Page 1: [20] Formatted** **Dave Lommen** **24/09/2018 10:00:00 AM**

Complex Script Font: +Body CS (Latha), 11 pt

**Page 1: [21] Formatted** **Dave Lommen** **24/09/2018 10:00:00 AM**

Complex Script Font: +Body CS (Latha), 11 pt

**Page 1: [21] Formatted** **Dave Lommen** **24/09/2018 10:00:00 AM**

Complex Script Font: +Body CS (Latha), 11 pt

**Page 1: [22] Formatted** **Dave Lommen** **24/09/2018 10:00:00 AM**

Complex Script Font: +Body CS (Latha), 11 pt

**Page 1: [22] Formatted** **Dave Lommen** **24/09/2018 10:00:00 AM**

Complex Script Font: +Body CS (Latha), 11 pt

**Page 1: [22] Formatted** **Dave Lommen** **24/09/2018 10:00:00 AM**

Complex Script Font: +Body CS (Latha), 11 pt

**Page 1: [23] Formatted** **Dave Lommen** **24/09/2018 10:00:00 AM**

Complex Script Font: +Body CS (Latha), 11 pt

**Page 1: [23] Formatted** **Dave Lommen** **24/09/2018 10:00:00 AM**

Complex Script Font: +Body CS (Latha), 11 pt

**Page 1: [24] Formatted** **Dave Lommen** **24/09/2018 10:00:00 AM**

Complex Script Font: +Body CS (Latha), 11 pt

**Page 1: [24] Formatted** **Dave Lommen** **24/09/2018 10:00:00 AM**

Complex Script Font: +Body CS (Latha), 11 pt

**Page 1: [24] Formatted** **Dave Lommen** **24/09/2018 10:00:00 AM**

Complex Script Font: +Body CS (Latha), 11 pt

**Page 1: [24] Formatted** **Dave Lommen** **24/09/2018 10:00:00 AM**

Complex Script Font: +Body CS (Latha), 11 pt

**Page 1: [25] Formatted** **Dave Lommen** **24/09/2018 10:00:00 AM**

Complex Script Font: +Body CS (Latha), 11 pt

**Page 1: [25] Formatted** **Dave Lommen** **24/09/2018 10:00:00 AM**

Complex Script Font: +Body CS (Latha), 11 pt

**Page 1: [25] Formatted** **Dave Lommen** **24/09/2018 10:00:00 AM**

Complex Script Font: +Body CS (Latha), 11 pt

**Page 1: [25] Formatted** **Dave Lommen** **24/09/2018 10:00:00 AM**

Complex Script Font: +Body CS (Latha), 11 pt

**Page 1: [25] Formatted** **Dave Lommen** **24/09/2018 10:00:00 AM**

Complex Script Font: +Body CS (Latha), 11 pt

**Page 1: [25] Formatted** **Dave Lommen** **24/09/2018 10:00:00 AM**

Complex Script Font: +Body CS (Latha), 11 pt

**Page 1: [25] Formatted** **Dave Lommen** **24/09/2018 10:00:00 AM**

Complex Script Font: +Body CS (Latha), 11 pt

**Page 1: [25] Formatted** **Dave Lommen** **24/09/2018 10:00:00 AM**

Complex Script Font: +Body CS (Latha), 11 pt

**Page 1: [25] Formatted** **Dave Lommen** **24/09/2018 10:00:00 AM**

Complex Script Font: +Body CS (Latha), 11 pt

**Page 1: [25] Formatted** **Dave Lommen** **24/09/2018 10:00:00 AM**

Complex Script Font: +Body CS (Latha), 11 pt

**Page 1: [26] Formatted** **Dave Lommen** **24/09/2018 10:00:00 AM**

Complex Script Font: +Body CS (Latha), 11 pt

**Page 1: [26] Formatted** **Dave Lommen** **24/09/2018 10:00:00 AM**

Complex Script Font: +Body CS (Latha), 11 pt

**Page 1: [27] Formatted** **Dave Lommen** **24/09/2018 10:00:00 AM**

Complex Script Font: +Body CS (Latha), 11 pt

**Page 1: [27] Formatted** **Dave Lommen** **24/09/2018 10:00:00 AM**

Complex Script Font: +Body CS (Latha), 11 pt

**Page 1: [28] Formatted** **Dave Lommen** **24/09/2018 10:00:00 AM**

Complex Script Font: +Body CS (Latha), 11 pt

**Page 1: [28] Formatted** **Dave Lommen** **24/09/2018 10:00:00 AM**

Complex Script Font: +Body CS (Latha), 11 pt

**Page 1: [29] Formatted** **Dave Lommen** **24/09/2018 10:00:00 AM**

Complex Script Font: +Body CS (Latha), 11 pt

**Page 1: [29] Formatted** **Dave Lommen** **24/09/2018 10:00:00 AM**

Complex Script Font: +Body CS (Latha), 11 pt

**Page 1: [30] Formatted** **Dave Lommen** **24/09/2018 10:00:00 AM**

Complex Script Font: +Body CS (Latha), 11 pt

**Page 1: [30] Formatted** **Dave Lommen** **24/09/2018 10:00:00 AM**

Complex Script Font: +Body CS (Latha), 11 pt

**Page 1: [31] Formatted** **Dave Lommen** **24/09/2018 10:00:00 AM**

Complex Script Font: +Body CS (Latha), 11 pt

**Page 1: [31] Formatted** **Dave Lommen** **24/09/2018 10:00:00 AM**

Complex Script Font: +Body CS (Latha), 11 pt

**Page 1: [32] Formatted** **Dave Lommen** **24/09/2018 10:00:00 AM**

Complex Script Font: +Body CS (Latha), 11 pt

**Page 1: [32] Formatted** **Dave Lommen** **24/09/2018 10:00:00 AM**

Complex Script Font: +Body CS (Latha), 11 pt

**Page 1: [33] Formatted** **Dave Lommen** **24/09/2018 10:00:00 AM**

Complex Script Font: +Body CS (Latha), 11 pt

**Page 1: [33] Formatted** **Dave Lommen** **24/09/2018 10:00:00 AM**

Complex Script Font: +Body CS (Latha), 11 pt

**Page 2: [34] Formatted** **Dave Lommen** **24/09/2018 10:00:00 AM**

Complex Script Font: +Body CS (Latha), 11 pt

**Page 2: [34] Formatted** **Dave Lommen** **24/09/2018 10:00:00 AM**

Complex Script Font: +Body CS (Latha), 11 pt

**Page 2: [35] Formatted** **Dave Lommen** **24/09/2018 10:00:00 AM**

Complex Script Font: +Body CS (Latha), 11 pt

**Page 2: [35] Formatted** **Dave Lommen** **24/09/2018 10:00:00 AM**

Complex Script Font: +Body CS (Latha), 11 pt

**Page 2: [36] Formatted** **Dave Lommen** **24/09/2018 10:00:00 AM**

Complex Script Font: +Body CS (Latha), 11 pt

**Page 2: [36] Formatted** **Dave Lommen** **24/09/2018 10:00:00 AM**

Complex Script Font: +Body CS (Latha), 11 pt

**Page 2: [37] Formatted** **Dave Lommen** **24/09/2018 10:00:00 AM**

Complex Script Font: +Body CS (Latha), 11 pt

**Page 2: [37] Formatted** **Dave Lommen** **24/09/2018 10:00:00 AM**

Complex Script Font: +Body CS (Latha), 11 pt

**Page 2: [38] Formatted** **Dave Lommen** **24/09/2018 10:00:00 AM**

Complex Script Font: +Body CS (Latha), 11 pt

**Page 2: [38] Formatted** **Dave Lommen** **24/09/2018 10:00:00 AM**

Complex Script Font: +Body CS (Latha), 11 pt

**Page 2: [39] Formatted** **Dave Lommen** **24/09/2018 10:00:00 AM**

Complex Script Font: +Body CS (Latha), 11 pt

**Page 2: [39] Formatted** **Dave Lommen** **24/09/2018 10:00:00 AM**

Complex Script Font: +Body CS (Latha), 11 pt

**Page 2: [39] Formatted** **Dave Lommen** **24/09/2018 10:00:00 AM**

Complex Script Font: +Body CS (Latha), 11 pt

**Page 2: [39] Formatted** **Dave Lommen** **24/09/2018 10:00:00 AM**

Complex Script Font: +Body CS (Latha), 11 pt

**Page 2: [40] Formatted** **Dave Lommen** **24/09/2018 10:00:00 AM**

Complex Script Font: +Body CS (Latha), 11 pt

**Page 2: [40] Formatted** **Dave Lommen** **24/09/2018 10:00:00 AM**

Complex Script Font: +Body CS (Latha), 11 pt

**Page 2: [40] Formatted** **Dave Lommen** **24/09/2018 10:00:00 AM**

Complex Script Font: +Body CS (Latha), 11 pt



**Page 2: [40] Formatted** **Dave Lommen** **24/09/2018 10:00:00 AM**

Complex Script Font: +Body CS (Latha), 11 pt

**Page 2: [40] Formatted** **Dave Lommen** **24/09/2018 10:00:00 AM**

Complex Script Font: +Body CS (Latha), 11 pt

**Page 2: [40] Formatted** **Dave Lommen** **24/09/2018 10:00:00 AM**

Complex Script Font: +Body CS (Latha), 11 pt

**Page 2: [41] Formatted** **Dave Lommen** **24/09/2018 10:00:00 AM**

Complex Script Font: +Body CS (Latha), 11 pt

**Page 2: [41] Formatted** **Dave Lommen** **24/09/2018 10:00:00 AM**

Complex Script Font: +Body CS (Latha), 11 pt

**Page 2: [42] Formatted** **Dave Lommen** **24/09/2018 10:00:00 AM**

Complex Script Font: +Body CS (Latha), 11 pt

**Page 2: [42] Formatted** **Dave Lommen** **24/09/2018 10:00:00 AM**

Complex Script Font: +Body CS (Latha), 11 pt

**Page 2: [43] Formatted** **Dave Lommen** **24/09/2018 10:00:00 AM**

Complex Script Font: +Body CS (Latha), 11 pt

**Page 2: [43] Formatted** **Dave Lommen** **24/09/2018 10:00:00 AM**

Complex Script Font: +Body CS (Latha), 11 pt

**Page 2: [44] Formatted** **Dave Lommen** **24/09/2018 10:00:00 AM**

Complex Script Font: +Body CS (Latha), 11 pt

**Page 2: [44] Formatted** **Dave Lommen** **24/09/2018 10:00:00 AM**

Complex Script Font: +Body CS (Latha), 11 pt

**Page 2: [45] Formatted** **Dave Lommen** **24/09/2018 10:00:00 AM**

Complex Script Font: +Body CS (Latha), 11 pt

**Page 2: [45] Formatted** **Dave Lommen** **24/09/2018 10:00:00 AM**

Complex Script Font: +Body CS (Latha), 11 pt

**Page 2: [46] Formatted** **Dave Lommen** **24/09/2018 10:00:00 AM**

Complex Script Font: +Body CS (Latha), 11 pt

**Page 2: [46] Formatted** **Dave Lommen** **24/09/2018 10:00:00 AM**

Complex Script Font: +Body CS (Latha), 11 pt

**Page 2: [47] Formatted** **Dave Lommen** **24/09/2018 10:00:00 AM**

Complex Script Font: +Body CS (Latha), 11 pt

**Page 2: [47] Formatted** **Dave Lommen** **24/09/2018 10:00:00 AM**

Complex Script Font: +Body CS (Latha), 11 pt

**Page 2: [48] Formatted** **Dave Lommen** **24/09/2018 10:00:00 AM**

Complex Script Font: +Body CS (Latha), 11 pt

**Page 2: [48] Formatted** **Dave Lommen** **24/09/2018 10:00:00 AM**

Complex Script Font: +Body CS (Latha), 11 pt

**Page 2: [49] Formatted** **Dave Lommen** **24/09/2018 10:00:00 AM**

Complex Script Font: +Body CS (Latha), 11 pt

**Page 2: [49] Formatted** **Dave Lommen** **24/09/2018 10:00:00 AM**

Complex Script Font: +Body CS (Latha), 11 pt

**Page 2: [50] Formatted** **Dave Lommen** **24/09/2018 10:00:00 AM**

Complex Script Font: +Body CS (Latha), 11 pt

**Page 2: [50] Formatted** **Dave Lommen** **24/09/2018 10:00:00 AM**

Complex Script Font: +Body CS (Latha), 11 pt

**Page 2: [51] Formatted** **Dave Lommen** **24/09/2018 10:00:00 AM**

Complex Script Font: +Body CS (Latha), 11 pt

**Page 2: [51] Formatted** **Dave Lommen** **24/09/2018 10:00:00 AM**

Complex Script Font: +Body CS (Latha), 11 pt

**Page 2: [52] Formatted** **Dave Lommen** **24/09/2018 10:00:00 AM**

Complex Script Font: +Body CS (Latha), 11 pt

**Page 2: [52] Formatted** **Dave Lommen** **24/09/2018 10:00:00 AM**

Complex Script Font: +Body CS (Latha), 11 pt

**Page 2: [52] Formatted** **Dave Lommen** **24/09/2018 10:00:00 AM**

Complex Script Font: +Body CS (Latha), 11 pt

**Page 2: [52] Formatted** **Dave Lommen** **24/09/2018 10:00:00 AM**

Complex Script Font: +Body CS (Latha), 11 pt

**Page 2: [53] Formatted** **Dave Lommen** **24/09/2018 10:00:00 AM**

Complex Script Font: +Body CS (Latha), 11 pt

**Page 2: [53] Formatted** **Dave Lommen** **24/09/2018 10:00:00 AM**

Complex Script Font: +Body CS (Latha), 11 pt

**Page 2: [53] Formatted** **Dave Lommen** **24/09/2018 10:00:00 AM**

Complex Script Font: +Body CS (Latha), 11 pt

**Page 2: [53] Formatted** **Dave Lommen** **24/09/2018 10:00:00 AM**

Complex Script Font: +Body CS (Latha), 11 pt

**Page 2: [54] Formatted** **Dave Lommen** **24/09/2018 10:00:00 AM**

Complex Script Font: +Body CS (Latha), 11 pt

**Page 2: [55] Formatted** **Dave Lommen** **24/09/2018 10:00:00 AM**

Complex Script Font: +Body CS (Latha), 11 pt

**Page 2: [55] Formatted** **Dave Lommen** **24/09/2018 10:00:00 AM**

Complex Script Font: +Body CS (Latha), 11 pt

**Page 2: [55] Formatted** **Dave Lommen** **24/09/2018 10:00:00 AM**

Complex Script Font: +Body CS (Latha), 11 pt

**Page 2: [55] Formatted** **Dave Lommen** **24/09/2018 10:00:00 AM**

Complex Script Font: +Body CS (Latha), 11 pt

**Page 2: [55] Formatted** **Dave Lommen** **24/09/2018 10:00:00 AM**

Complex Script Font: +Body CS (Latha), 11 pt

**Page 2: [55] Formatted** **Dave Lommen** **24/09/2018 10:00:00 AM**

Complex Script Font: +Body CS (Latha), 11 pt

**Page 2: [55] Formatted** **Dave Lommen** **24/09/2018 10:00:00 AM**

Complex Script Font: +Body CS (Latha), 11 pt

**Page 2: [55] Formatted** **Dave Lommen** **24/09/2018 10:00:00 AM**

Complex Script Font: +Body CS (Latha), 11 pt

**Page 2: [55] Formatted** **Dave Lommen** **24/09/2018 10:00:00 AM**

Complex Script Font: +Body CS (Latha), 11 pt

**Page 2: [55] Formatted** **Dave Lommen** **24/09/2018 10:00:00 AM**

Complex Script Font: +Body CS (Latha), 11 pt

**Page 2: [56] Formatted** **Dave Lommen** **24/09/2018 10:00:00 AM**

Complex Script Font: +Body CS (Latha), 11 pt

**Page 2: [57] Formatted** **Dave Lommen** **24/09/2018 10:00:00 AM**

Complex Script Font: +Body CS (Latha), 11 pt, English (Singapore)

**Page 2: [58] Formatted** **Dave Lommen** **24/09/2018 10:00:00 AM**

Complex Script Font: +Body CS (Latha), 11 pt

**Page 2: [58] Formatted** **Dave Lommen** **24/09/2018 10:00:00 AM**

Complex Script Font: +Body CS (Latha), 11 pt

**Page 2: [59] Formatted** **Dave Lommen** **24/09/2018 10:00:00 AM**

Complex Script Font: +Body CS (Latha), 11 pt

**Page 2: [59] Formatted** **Dave Lommen** **24/09/2018 10:00:00 AM**

Complex Script Font: +Body CS (Latha), 11 pt

**Page 3: [60] Formatted** **Dave Lommen** **24/09/2018 10:00:00 AM**

Complex Script Font: +Body CS (Latha), 11 pt

**Page 3: [60] Formatted** **Dave Lommen** **24/09/2018 10:00:00 AM**

Complex Script Font: +Body CS (Latha), 11 pt

**Page 3: [61] Formatted** **Dave Lommen** **24/09/2018 10:00:00 AM**

Complex Script Font: +Body CS (Latha), 11 pt

**Page 3: [61] Formatted** **Dave Lommen** **24/09/2018 10:00:00 AM**

Complex Script Font: +Body CS (Latha), 11 pt

**Page 3: [62] Formatted** **Dave Lommen** **24/09/2018 10:00:00 AM**

Complex Script Font: +Body CS (Latha), 11 pt

**Page 3: [63] Formatted** **Dave Lommen** **24/09/2018 10:00:00 AM**

Complex Script Font: +Body CS (Latha), 11 pt, English (Singapore)

**Page 3: [64] Formatted** **Dave Lommen** **24/09/2018 10:00:00 AM**

Complex Script Font: +Body CS (Latha), 11 pt

**Page 3: [64] Formatted** **Dave Lommen** **24/09/2018 10:00:00 AM**

Complex Script Font: +Body CS (Latha), 11 pt

**Page 3: [64] Formatted** **Dave Lommen** **24/09/2018 10:00:00 AM**

Complex Script Font: +Body CS (Latha), 11 pt

**Page 3: [64] Formatted** **Dave Lommen** **24/09/2018 10:00:00 AM**

Complex Script Font: +Body CS (Latha), 11 pt

**Page 3: [64] Formatted** **Dave Lommen** **24/09/2018 10:00:00 AM**

Complex Script Font: +Body CS (Latha), 11 pt

**Page 3: [64] Formatted** **Dave Lommen** **24/09/2018 10:00:00 AM**

Complex Script Font: +Body CS (Latha), 11 pt

**Page 3: [64] Formatted** **Dave Lommen** **24/09/2018 10:00:00 AM**

Complex Script Font: +Body CS (Latha), 11 pt

**Page 3: [64] Formatted** **Dave Lommen** **24/09/2018 10:00:00 AM**

Complex Script Font: +Body CS (Latha), 11 pt

**Page 3: [64] Formatted** **Dave Lommen** **24/09/2018 10:00:00 AM**

Complex Script Font: +Body CS (Latha), 11 pt

**Page 3: [64] Formatted** **Dave Lommen** **24/09/2018 10:00:00 AM**

Complex Script Font: +Body CS (Latha), 11 pt

**Page 3: [64] Formatted** **Dave Lommen** **24/09/2018 10:00:00 AM**

Complex Script Font: +Body CS (Latha), 11 pt

**Page 3: [65] Formatted** **Dave Lommen** **24/09/2018 10:00:00 AM**

Complex Script Font: +Body CS (Latha), 11 pt

**Page 3: [66] Formatted** **Dave Lommen** **24/09/2018 10:00:00 AM**

Complex Script Font: +Body CS (Latha), 11 pt

**Page 3: [66] Formatted** **Dave Lommen** **24/09/2018 10:00:00 AM**

Complex Script Font: +Body CS (Latha), 11 pt

**Page 3: [66] Formatted** **Dave Lommen** **24/09/2018 10:00:00 AM**

Complex Script Font: +Body CS (Latha), 11 pt

**Page 3: [66] Formatted** **Dave Lommen** **24/09/2018 10:00:00 AM**

Complex Script Font: +Body CS (Latha), 11 pt

**Page 3: [67] Formatted** **Dave Lommen** **24/09/2018 10:00:00 AM**

Complex Script Font: +Body CS (Latha), 11 pt

**Page 3: [67] Formatted** **Dave Lommen** **24/09/2018 10:00:00 AM**

Complex Script Font: +Body CS (Latha), 11 pt

**Page 3: [68] Formatted** **Dave Lommen** **24/09/2018 10:00:00 AM**

Complex Script Font: +Body CS (Latha), 11 pt, English (Singapore)

**Page 3: [69] Formatted** **Dave Lommen** **24/09/2018 10:00:00 AM**

Complex Script Font: +Body CS (Latha), 11 pt

**Page 3: [69] Formatted** **Dave Lommen** **24/09/2018 10:00:00 AM**

Complex Script Font: +Body CS (Latha), 11 pt

**Page 3: [70] Formatted** **Dave Lommen** **24/09/2018 10:00:00 AM**

Complex Script Font: +Body CS (Latha), 11 pt

**Page 3: [70] Formatted** **Dave Lommen** **24/09/2018 10:00:00 AM**

Complex Script Font: +Body CS (Latha), 11 pt

**Page 3: [71] Formatted** **Dave Lommen** **24/09/2018 10:00:00 AM**

Complex Script Font: +Body CS (Latha), 11 pt

**Page 3: [72] Formatted** **Dave Lommen** **24/09/2018 10:00:00 AM**

Complex Script Font: +Body CS (Latha), 11 pt

**Page 3: [72] Formatted** **Dave Lommen** **24/09/2018 10:00:00 AM**

Complex Script Font: +Body CS (Latha), 11 pt

**Page 3: [72] Formatted** **Dave Lommen** **24/09/2018 10:00:00 AM**

Complex Script Font: +Body CS (Latha), 11 pt

**Page 3: [72] Formatted** **Dave Lommen** **24/09/2018 10:00:00 AM**

Complex Script Font: +Body CS (Latha), 11 pt

**Page 3: [73] Formatted** **Dave Lommen** **24/09/2018 10:00:00 AM**

Complex Script Font: +Body CS (Latha), 11 pt, (Asian) Chinese (PRC), (Other) English (Singapore)

**Page 3: [74] Formatted** **Dave Lommen** **24/09/2018 10:00:00 AM**

Complex Script Font: +Body CS (Latha), 11 pt, (Asian) Chinese (PRC)

**Page 3: [74] Formatted** **Dave Lommen** **24/09/2018 10:00:00 AM**

Complex Script Font: +Body CS (Latha), 11 pt, (Asian) Chinese (PRC)

**Page 3: [75] Formatted** **Dave Lommen** **24/09/2018 10:00:00 AM**

Complex Script Font: +Body CS (Latha), 11 pt, (Asian) Chinese (PRC)

**Page 3: [75] Formatted** **Dave Lommen** **24/09/2018 10:00:00 AM**

Complex Script Font: +Body CS (Latha), 11 pt, (Asian) Chinese (PRC)

**Page 3: [76] Formatted** **Dave Lommen** **24/09/2018 10:00:00 AM**

Complex Script Font: +Body CS (Latha), 11 pt

**Page 3: [76] Formatted** **Dave Lommen** **24/09/2018 10:00:00 AM**

Complex Script Font: +Body CS (Latha), 11 pt

**Page 3: [77] Formatted** **Dave Lommen** **24/09/2018 10:00:00 AM**

Complex Script Font: +Body CS (Latha), 11 pt

**Page 3: [77] Formatted** **Dave Lommen** **24/09/2018 10:00:00 AM**

Complex Script Font: +Body CS (Latha), 11 pt

**Page 3: [78] Formatted** **Dave Lommen** **24/09/2018 10:00:00 AM**

Complex Script Font: +Body CS (Latha), 11 pt

**Page 3: [78] Formatted** **Dave Lommen** **24/09/2018 10:00:00 AM**

Complex Script Font: +Body CS (Latha), 11 pt

**Page 3: [79] Formatted** **Dave Lommen** **24/09/2018 10:00:00 AM**

Complex Script Font: +Body CS (Latha), 11 pt

**Page 3: [79] Formatted** **Dave Lommen** **24/09/2018 10:00:00 AM**

Complex Script Font: +Body CS (Latha), 11 pt

**Page 3: [80] Formatted** **Dave Lommen** **24/09/2018 10:00:00 AM**

Complex Script Font: +Body CS (Latha), 11 pt, English (Singapore)

**Page 3: [81] Formatted** **Dave Lommen** **24/09/2018 10:00:00 AM**

Complex Script Font: +Body CS (Latha), 11 pt

**Page 3: [81] Formatted** **Dave Lommen** **24/09/2018 10:00:00 AM**

Complex Script Font: +Body CS (Latha), 11 pt

**Page 3: [82] Formatted** **Dave Lommen** **24/09/2018 10:00:00 AM**

Complex Script Font: +Body CS (Latha), 11 pt

**Page 3: [82] Formatted** **Dave Lommen** **24/09/2018 10:00:00 AM**

Complex Script Font: +Body CS (Latha), 11 pt

**Page 3: [83] Formatted** **Dave Lommen** **24/09/2018 10:00:00 AM**

Complex Script Font: +Body CS (Latha), 11 pt

**Page 3: [83] Formatted** **Dave Lommen** **24/09/2018 10:00:00 AM**

Complex Script Font: +Body CS (Latha), 11 pt

**Page 3: [84] Formatted** **Dave Lommen** **24/09/2018 10:00:00 AM**

Complex Script Font: +Body CS (Latha), 11 pt

**Page 3: [84] Formatted** **Dave Lommen** **24/09/2018 10:00:00 AM**

Complex Script Font: +Body CS (Latha), 11 pt

**Page 3: [85] Formatted** **Dave Lommen** **24/09/2018 10:00:00 AM**

Complex Script Font: +Body CS (Latha), 11 pt

**Page 3: [85] Formatted** **Dave Lommen** **24/09/2018 10:00:00 AM**

Complex Script Font: +Body CS (Latha), 11 pt

**Page 3: [86] Formatted** **Dave Lommen** **24/09/2018 10:00:00 AM**

Complex Script Font: +Body CS (Latha), 11 pt

**Page 3: [86] Formatted** **Dave Lommen** **24/09/2018 10:00:00 AM**

Complex Script Font: +Body CS (Latha), 11 pt

**Page 3: [87] Formatted** **Dave Lommen** **24/09/2018 10:00:00 AM**

Complex Script Font: +Body CS (Latha), 11 pt

**Page 3: [87] Formatted** **Dave Lommen** **24/09/2018 10:00:00 AM**

Complex Script Font: +Body CS (Latha), 11 pt

**Page 3: [88] Formatted** **Dave Lommen** **24/09/2018 10:00:00 AM**

Complex Script Font: +Body CS (Latha), 11 pt

**Page 3: [88] Formatted** **Dave Lommen** **24/09/2018 10:00:00 AM**

Complex Script Font: +Body CS (Latha), 11 pt

**Page 3: [89] Formatted** **Dave Lommen** **24/09/2018 10:00:00 AM**

Complex Script Font: +Body CS (Latha), 11 pt

**Page 3: [89] Formatted** **Dave Lommen** **24/09/2018 10:00:00 AM**

Complex Script Font: +Body CS (Latha), 11 pt

**Page 3: [90] Formatted** **Dave Lommen** **24/09/2018 10:00:00 AM**

Complex Script Font: +Body CS (Latha), 11 pt

**Page 3: [90] Formatted** **Dave Lommen** **24/09/2018 10:00:00 AM**

Complex Script Font: +Body CS (Latha), 11 pt

**Page 3: [91] Formatted** **Dave Lommen** **24/09/2018 10:00:00 AM**

Complex Script Font: +Body CS (Latha), 11 pt

**Page 3: [91] Formatted** **Dave Lommen** **24/09/2018 10:00:00 AM**

Complex Script Font: +Body CS (Latha), 11 pt

**Page 3: [92] Formatted** **Dave Lommen** **24/09/2018 10:00:00 AM**

Complex Script Font: +Body CS (Latha), 11 pt

**Page 3: [92] Formatted** **Dave Lommen** **24/09/2018 10:00:00 AM**

Complex Script Font: +Body CS (Latha), 11 pt

**Page 3: [93] Formatted** **Dave Lommen** **24/09/2018 10:00:00 AM**

Complex Script Font: +Body CS (Latha), 11 pt

**Page 3: [93] Formatted** **Dave Lommen** **24/09/2018 10:00:00 AM**

Complex Script Font: +Body CS (Latha), 11 pt

**Page 3: [94] Formatted** **Dave Lommen** **24/09/2018 10:00:00 AM**

Complex Script Font: +Body CS (Latha), 11 pt

**Page 3: [94] Formatted** **Dave Lommen** **24/09/2018 10:00:00 AM**

Complex Script Font: +Body CS (Latha), 11 pt

**Page 3: [95] Formatted** **Dave Lommen** **24/09/2018 10:00:00 AM**

Complex Script Font: +Body CS (Latha), 11 pt

**Page 3: [95] Formatted** **Dave Lommen** **24/09/2018 10:00:00 AM**

Complex Script Font: +Body CS (Latha), 11 pt



<b>Page 3: [96] Formatted</b>	<b>Dave Lommen</b>	<b>24/09/2018 10:00:00 AM</b>
-------------------------------	--------------------	-------------------------------

Complex Script Font: +Body CS (Latha), 11 pt

<b>Page 3: [96] Formatted</b>	<b>Dave Lommen</b>	<b>24/09/2018 10:00:00 AM</b>
-------------------------------	--------------------	-------------------------------

Complex Script Font: +Body CS (Latha), 11 pt

<b>Page 3: [97] Formatted</b>	<b>Dave Lommen</b>	<b>24/09/2018 10:00:00 AM</b>
-------------------------------	--------------------	-------------------------------

Complex Script Font: +Body CS (Latha), 11 pt

<b>Page 3: [97] Formatted</b>	<b>Dave Lommen</b>	<b>24/09/2018 10:00:00 AM</b>
-------------------------------	--------------------	-------------------------------

Complex Script Font: +Body CS (Latha), 11 pt

<b>Page 3: [98] Formatted</b>	<b>Dave Lommen</b>	<b>24/09/2018 10:00:00 AM</b>
-------------------------------	--------------------	-------------------------------

Complex Script Font: +Body CS (Latha), 11 pt

<b>Page 3: [99] Change</b>	<b>Unknown</b>	
----------------------------	----------------	--

Field Code Changed

<b>Page 3: [100] Formatted</b>	<b>Dave Lommen</b>	<b>24/09/2018 10:00:00 AM</b>
--------------------------------	--------------------	-------------------------------

Complex Script Font: +Body CS (Latha), 11 pt

<b>Page 3: [100] Formatted</b>	<b>Dave Lommen</b>	<b>24/09/2018 10:00:00 AM</b>
--------------------------------	--------------------	-------------------------------

Complex Script Font: +Body CS (Latha), 11 pt

<b>Page 3: [101] Formatted</b>	<b>Dave Lommen</b>	<b>24/09/2018 10:00:00 AM</b>
--------------------------------	--------------------	-------------------------------

Complex Script Font: +Body CS (Latha), 11 pt

<b>Page 3: [101] Formatted</b>	<b>Dave Lommen</b>	<b>24/09/2018 10:00:00 AM</b>
--------------------------------	--------------------	-------------------------------

Complex Script Font: +Body CS (Latha), 11 pt

<b>Page 3: [102] Formatted</b>	<b>Dave Lommen</b>	<b>24/09/2018 10:00:00 AM</b>
--------------------------------	--------------------	-------------------------------

Complex Script Font: +Body CS (Latha), 11 pt

<b>Page 3: [102] Formatted</b>	<b>Dave Lommen</b>	<b>24/09/2018 10:00:00 AM</b>
--------------------------------	--------------------	-------------------------------

Complex Script Font: +Body CS (Latha), 11 pt

<b>Page 3: [103] Formatted</b>	<b>Dave Lommen</b>	<b>24/09/2018 10:00:00 AM</b>
--------------------------------	--------------------	-------------------------------

Complex Script Font: +Body CS (Latha), 11 pt

<b>Page 3: [103] Formatted</b>	<b>Dave Lommen</b>	<b>24/09/2018 10:00:00 AM</b>
--------------------------------	--------------------	-------------------------------

Complex Script Font: +Body CS (Latha), 11 pt

<b>Page 3: [104] Formatted</b>	<b>Dave Lommen</b>	<b>24/09/2018 10:00:00 AM</b>
--------------------------------	--------------------	-------------------------------

Complex Script Font: +Body CS (Latha), 11 pt

<b>Page 3: [104] Formatted</b>	<b>Dave Lommen</b>	<b>24/09/2018 10:00:00 AM</b>
--------------------------------	--------------------	-------------------------------

Complex Script Font: +Body CS (Latha), 11 pt

<b>Page 3: [105] Formatted</b>	<b>Dave Lommen</b>	<b>24/09/2018 10:00:00 AM</b>
--------------------------------	--------------------	-------------------------------

Complex Script Font: +Body CS (Latha), 11 pt

<b>Page 3: [105] Formatted</b>	<b>Dave Lommen</b>	<b>24/09/2018 10:00:00 AM</b>
--------------------------------	--------------------	-------------------------------

Complex Script Font: +Body CS (Latha), 11 pt

<b>Page 3: [106] Formatted</b>	<b>Dave Lommen</b>	<b>24/09/2018 10:00:00 AM</b>
--------------------------------	--------------------	-------------------------------

Complex Script Font: +Body CS (Latha), 11 pt

<b>Page 3: [106] Formatted</b>	<b>Dave Lommen</b>	<b>24/09/2018 10:00:00 AM</b>
--------------------------------	--------------------	-------------------------------

Complex Script Font: +Body CS (Latha), 11 pt

<b>Page 3: [107] Formatted</b>	<b>Dave Lommen</b>	<b>24/09/2018 10:00:00 AM</b>
--------------------------------	--------------------	-------------------------------

Complex Script Font: +Body CS (Latha), 11 pt

<b>Page 3: [108] Change</b>	<b>Unknown</b>	
-----------------------------	----------------	--

Field Code Changed

<b>Page 3: [109] Formatted</b>	<b>Dave Lommen</b>	<b>24/09/2018 10:00:00 AM</b>
--------------------------------	--------------------	-------------------------------

Complex Script Font: +Body CS (Latha), 11 pt, English (Singapore)

<b>Page 3: [110] Formatted</b>	<b>Dave Lommen</b>	<b>24/09/2018 10:00:00 AM</b>
--------------------------------	--------------------	-------------------------------

Complex Script Font: +Body CS (Latha), 11 pt

<b>Page 3: [111] Formatted</b>	<b>Dave Lommen</b>	<b>24/09/2018 10:00:00 AM</b>
--------------------------------	--------------------	-------------------------------

Complex Script Font: +Body CS (Latha), 11 pt

<b>Page 3: [111] Formatted</b>	<b>Dave Lommen</b>	<b>24/09/2018 10:00:00 AM</b>
--------------------------------	--------------------	-------------------------------

Complex Script Font: +Body CS (Latha), 11 pt

<b>Page 3: [112] Formatted</b>	<b>Dave Lommen</b>	<b>24/09/2018 10:00:00 AM</b>
--------------------------------	--------------------	-------------------------------

Complex Script Font: +Body CS (Latha), 11 pt

<b>Page 3: [112] Formatted</b>	<b>Dave Lommen</b>	<b>24/09/2018 10:00:00 AM</b>
--------------------------------	--------------------	-------------------------------

Complex Script Font: +Body CS (Latha), 11 pt

<b>Page 3: [113] Formatted</b>	<b>Dave Lommen</b>	<b>24/09/2018 10:00:00 AM</b>
--------------------------------	--------------------	-------------------------------

Complex Script Font: +Body CS (Latha), 11 pt

<b>Page 3: [114] Formatted</b>	<b>Dave Lommen</b>	<b>24/09/2018 10:00:00 AM</b>
--------------------------------	--------------------	-------------------------------

Complex Script Font: +Body CS (Latha), 11 pt, English (Singapore)

<b>Page 3: [115] Formatted</b>	<b>Dave Lommen</b>	<b>24/09/2018 10:00:00 AM</b>
--------------------------------	--------------------	-------------------------------

Complex Script Font: +Body CS (Latha), 11 pt, English (Singapore)

<b>Page 3: [116] Formatted</b>	<b>Dave Lommen</b>	<b>24/09/2018 10:00:00 AM</b>
--------------------------------	--------------------	-------------------------------

Complex Script Font: +Body CS (Latha), 11 pt

**Page 3: [116] Formatted** **Dave Lommen** **24/09/2018 10:00:00 AM**

Complex Script Font: +Body CS (Latha), 11 pt

**Page 3: [117] Formatted** **Dave Lommen** **24/09/2018 10:00:00 AM**

Complex Script Font: +Body CS (Latha), 11 pt, English (Singapore)

**Page 3: [118] Formatted** **Dave Lommen** **24/09/2018 10:00:00 AM**

Complex Script Font: +Body CS (Latha), 11 pt

**Page 3: [118] Formatted** **Dave Lommen** **24/09/2018 10:00:00 AM**

Complex Script Font: +Body CS (Latha), 11 pt

**Page 3: [119] Formatted** **Dave Lommen** **24/09/2018 10:00:00 AM**

Complex Script Font: +Body CS (Latha), 11 pt

**Page 3: [119] Formatted** **Dave Lommen** **24/09/2018 10:00:00 AM**

Complex Script Font: +Body CS (Latha), 11 pt

**Page 3: [120] Formatted** **Dave Lommen** **24/09/2018 10:00:00 AM**

Complex Script Font: +Body CS (Latha), 11 pt

**Page 3: [120] Formatted** **Dave Lommen** **24/09/2018 10:00:00 AM**

Complex Script Font: +Body CS (Latha), 11 pt

**Page 4: [121] Formatted** **Dave Lommen** **24/09/2018 10:00:00 AM**

Complex Script Font: +Body CS (Latha), 11 pt

**Page 4: [121] Formatted** **Dave Lommen** **24/09/2018 10:00:00 AM**

Complex Script Font: +Body CS (Latha), 11 pt

**Page 4: [122] Formatted** **Dave Lommen** **24/09/2018 10:00:00 AM**

Complex Script Font: +Body CS (Latha), 11 pt

**Page 4: [122] Formatted** **Dave Lommen** **24/09/2018 10:00:00 AM**

Complex Script Font: +Body CS (Latha), 11 pt

**Page 4: [123] Formatted** **Dave Lommen** **24/09/2018 10:00:00 AM**

Complex Script Font: +Body CS (Latha), 11 pt

**Page 4: [123] Formatted** **Dave Lommen** **24/09/2018 10:00:00 AM**

Complex Script Font: +Body CS (Latha), 11 pt

**Page 4: [124] Formatted** **Dave Lommen** **24/09/2018 10:00:00 AM**

Complex Script Font: +Body CS (Latha), 11 pt

**Page 4: [124] Formatted** **Dave Lommen** **24/09/2018 10:00:00 AM**

Complex Script Font: +Body CS (Latha), 11 pt

**Page 4: [125] Formatted** **Dave Lommen** **24/09/2018 10:00:00 AM**

Complex Script Font: +Body CS (Latha), 11 pt

**Page 4: [125] Formatted** **Dave Lommen** **24/09/2018 10:00:00 AM**

Complex Script Font: +Body CS (Latha), 11 pt

**Page 4: [126] Formatted** **Dave Lommen** **24/09/2018 10:00:00 AM**

Complex Script Font: +Body CS (Latha), 11 pt

**Page 4: [126] Formatted** **Dave Lommen** **24/09/2018 10:00:00 AM**

Complex Script Font: +Body CS (Latha), 11 pt

**Page 4: [127] Formatted** **Dave Lommen** **24/09/2018 10:00:00 AM**

Complex Script Font: +Body CS (Latha), 11 pt

**Page 4: [127] Formatted** **Dave Lommen** **24/09/2018 10:00:00 AM**

Complex Script Font: +Body CS (Latha), 11 pt

**Page 4: [128] Formatted** **Dave Lommen** **24/09/2018 10:00:00 AM**

Complex Script Font: +Body CS (Latha), 11 pt

**Page 4: [128] Formatted** **Dave Lommen** **24/09/2018 10:00:00 AM**

Complex Script Font: +Body CS (Latha), 11 pt

**Page 4: [129] Formatted** **Dave Lommen** **24/09/2018 10:00:00 AM**

Complex Script Font: +Body CS (Latha), 11 pt

**Page 4: [129] Formatted** **Dave Lommen** **24/09/2018 10:00:00 AM**

Complex Script Font: +Body CS (Latha), 11 pt

**Page 4: [130] Formatted** **Dave Lommen** **24/09/2018 10:00:00 AM**

Complex Script Font: +Body CS (Latha), 11 pt

**Page 4: [130] Formatted** **Dave Lommen** **24/09/2018 10:00:00 AM**

Complex Script Font: +Body CS (Latha), 11 pt

**Page 4: [131] Formatted** **Dave Lommen** **24/09/2018 10:00:00 AM**

Complex Script Font: +Body CS (Latha), 11 pt

**Page 4: [131] Formatted** **Dave Lommen** **24/09/2018 10:00:00 AM**

Complex Script Font: +Body CS (Latha), 11 pt

**Page 4: [132] Formatted** **Dave Lommen** **24/09/2018 10:00:00 AM**

Complex Script Font: +Body CS (Latha), 11 pt

**Page 4: [132] Formatted** **Dave Lommen** **24/09/2018 10:00:00 AM**

Complex Script Font: +Body CS (Latha), 11 pt

**Page 4: [133] Formatted** **Dave Lommen** **24/09/2018 10:00:00 AM**

Complex Script Font: +Body CS (Latha), 11 pt

**Page 4: [133] Formatted** **Dave Lommen** **24/09/2018 10:00:00 AM**

Complex Script Font: +Body CS (Latha), 11 pt

**Page 4: [134] Formatted** **Dave Lommen** **24/09/2018 10:00:00 AM**

Complex Script Font: +Body CS (Latha), 11 pt

**Page 4: [134] Formatted** **Dave Lommen** **24/09/2018 10:00:00 AM**

Complex Script Font: +Body CS (Latha), 11 pt

**Page 4: [135] Formatted** **Dave Lommen** **24/09/2018 10:00:00 AM**

Complex Script Font: +Body CS (Latha), 11 pt

**Page 4: [135] Formatted** **Dave Lommen** **24/09/2018 10:00:00 AM**

Complex Script Font: +Body CS (Latha), 11 pt

**Page 4: [136] Formatted** **Dave Lommen** **24/09/2018 10:00:00 AM**

Complex Script Font: +Body CS (Latha), 11 pt

**Page 4: [136] Formatted** **Dave Lommen** **24/09/2018 10:00:00 AM**

Complex Script Font: +Body CS (Latha), 11 pt

**Page 4: [137] Formatted** **Dave Lommen** **24/09/2018 10:00:00 AM**

Complex Script Font: +Body CS (Latha), 11 pt

**Page 4: [137] Formatted** **Dave Lommen** **24/09/2018 10:00:00 AM**

Complex Script Font: +Body CS (Latha), 11 pt

**Page 4: [138] Formatted** **Dave Lommen** **24/09/2018 10:00:00 AM**

Complex Script Font: +Body CS (Latha), 11 pt

**Page 4: [138] Formatted** **Dave Lommen** **24/09/2018 10:00:00 AM**

Complex Script Font: +Body CS (Latha), 11 pt

**Page 4: [139] Formatted** **Dave Lommen** **24/09/2018 10:00:00 AM**

Complex Script Font: +Body CS (Latha), 11 pt

**Page 4: [139] Formatted** **Dave Lommen** **24/09/2018 10:00:00 AM**

Complex Script Font: +Body CS (Latha), 11 pt

**Page 4: [140] Formatted** **Dave Lommen** **24/09/2018 10:00:00 AM**

Complex Script Font: +Body CS (Latha), 11 pt

**Page 4: [140] Formatted** **Dave Lommen** **24/09/2018 10:00:00 AM**

Complex Script Font: +Body CS (Latha), 11 pt

**Page 5: [141] Formatted** **Dave Lommen** **24/09/2018 10:00:00 AM**

Complex Script Font: +Body CS (Latha), 11 pt

**Page 5: [141] Formatted** **Dave Lommen** **24/09/2018 10:00:00 AM**

Complex Script Font: +Body CS (Latha), 11 pt

**Page 5: [142] Formatted** **Dave Lommen** **24/09/2018 10:00:00 AM**

Complex Script Font: +Body CS (Latha), 11 pt

**Page 5: [142] Formatted** **Dave Lommen** **24/09/2018 10:00:00 AM**

Complex Script Font: +Body CS (Latha), 11 pt

**Page 5: [143] Formatted** **Dave Lommen** **24/09/2018 10:00:00 AM**

Complex Script Font: +Body CS (Latha), 11 pt

**Page 5: [143] Formatted** **Dave Lommen** **24/09/2018 10:00:00 AM**

Complex Script Font: +Body CS (Latha), 11 pt

**Page 5: [144] Formatted** **Dave Lommen** **24/09/2018 10:00:00 AM**

Complex Script Font: +Body CS (Latha), 11 pt

**Page 5: [144] Formatted** **Dave Lommen** **24/09/2018 10:00:00 AM**

Complex Script Font: +Body CS (Latha), 11 pt

**Page 5: [145] Formatted** **Dave Lommen** **24/09/2018 10:00:00 AM**

Complex Script Font: +Body CS (Latha), 11 pt

**Page 5: [145] Formatted** **Dave Lommen** **24/09/2018 10:00:00 AM**

Complex Script Font: +Body CS (Latha), 11 pt

**Page 5: [146] Formatted** **Dave Lommen** **24/09/2018 10:00:00 AM**

Complex Script Font: +Body CS (Latha), 11 pt

**Page 5: [146] Formatted** **Dave Lommen** **24/09/2018 10:00:00 AM**

Complex Script Font: +Body CS (Latha), 11 pt

**Page 5: [147] Change** **Unknown**

Field Code Changed

**Page 5: [148] Formatted** **Dave Lommen** **24/09/2018 10:00:00 AM**

Complex Script Font: +Body CS (Latha), 11 pt, English (Singapore)

**Page 5: [149] Formatted** **Dave Lommen** **24/09/2018 10:00:00 AM**

Complex Script Font: +Body CS (Latha), 11 pt

**Page 5: [149] Formatted** **Dave Lommen** **24/09/2018 10:00:00 AM**

Complex Script Font: +Body CS (Latha), 11 pt

**Page 5: [150] Formatted** **Dave Lommen** **24/09/2018 10:00:00 AM**

Complex Script Font: +Body CS (Latha), 11 pt

**Page 5: [150] Formatted** **Dave Lommen** **24/09/2018 10:00:00 AM**

Complex Script Font: +Body CS (Latha), 11 pt

**Page 5: [151] Formatted** **Dave Lommen** **24/09/2018 10:00:00 AM**

Complex Script Font: +Body CS (Latha), 11 pt, English (Singapore)

**Page 5: [152] Formatted** **Dave Lommen** **24/09/2018 10:00:00 AM**

Complex Script Font: +Body CS (Latha), 11 pt

**Page 5: [152] Formatted** **Dave Lommen** **24/09/2018 10:00:00 AM**

Complex Script Font: +Body CS (Latha), 11 pt

**Page 5: [153] Formatted** **Dave Lommen** **24/09/2018 10:00:00 AM**

Complex Script Font: +Body CS (Latha), 11 pt

**Page 5: [153] Formatted** **Dave Lommen** **24/09/2018 10:00:00 AM**

Complex Script Font: +Body CS (Latha), 11 pt

**Page 5: [154] Formatted** **Dave Lommen** **24/09/2018 10:00:00 AM**

Complex Script Font: +Body CS (Latha), 11 pt

**Page 5: [154] Formatted** **Dave Lommen** **24/09/2018 10:00:00 AM**

Complex Script Font: +Body CS (Latha), 11 pt

**Page 5: [155] Formatted** **Dave Lommen** **24/09/2018 10:00:00 AM**

Complex Script Font: +Body CS (Latha), 11 pt

**Page 5: [155] Formatted** **Dave Lommen** **24/09/2018 10:00:00 AM**

Complex Script Font: +Body CS (Latha), 11 pt

**Page 5: [156] Formatted** **Dave Lommen** **24/09/2018 10:00:00 AM**

Complex Script Font: +Body CS (Latha), 11 pt

**Page 5: [156] Formatted** **Dave Lommen** **24/09/2018 10:00:00 AM**

Complex Script Font: +Body CS (Latha), 11 pt

**Page 5: [157] Formatted** **Dave Lommen** **24/09/2018 10:00:00 AM**

Complex Script Font: +Body CS (Latha), 11 pt

**Page 5: [157] Formatted** **Dave Lommen** **24/09/2018 10:00:00 AM**

Complex Script Font: +Body CS (Latha), 11 pt

**Page 5: [158] Formatted** **Dave Lommen** **24/09/2018 10:00:00 AM**

Complex Script Font: +Body CS (Latha), 11 pt

**Page 5: [158] Formatted** **Dave Lommen** **24/09/2018 10:00:00 AM**

Complex Script Font: +Body CS (Latha), 11 pt

**Page 5: [159] Formatted** **Dave Lommen** **24/09/2018 10:00:00 AM**

Complex Script Font: +Body CS (Latha), 11 pt

**Page 5: [159] Formatted** **Dave Lommen** **24/09/2018 10:00:00 AM**

Complex Script Font: +Body CS (Latha), 11 pt

**Page 5: [160] Formatted** **Dave Lommen** **24/09/2018 10:00:00 AM**

Complex Script Font: +Body CS (Latha), 11 pt

**Page 5: [160] Formatted** **Dave Lommen** **24/09/2018 10:00:00 AM**

Complex Script Font: +Body CS (Latha), 11 pt

**Page 5: [161] Formatted** **Dave Lommen** **24/09/2018 10:00:00 AM**

Complex Script Font: +Body CS (Latha), 11 pt

**Page 5: [161] Formatted** **Dave Lommen** **24/09/2018 10:00:00 AM**

Complex Script Font: +Body CS (Latha), 11 pt

**Page 5: [162] Formatted** **Dave Lommen** **24/09/2018 10:00:00 AM**

Complex Script Font: +Body CS (Latha), 11 pt

**Page 5: [162] Formatted** **Dave Lommen** **24/09/2018 10:00:00 AM**

Complex Script Font: +Body CS (Latha), 11 pt

**Page 5: [163] Formatted** **Dave Lommen** **24/09/2018 10:00:00 AM**

Complex Script Font: +Body CS (Latha), 11 pt

**Page 5: [163] Formatted** **Dave Lommen** **24/09/2018 10:00:00 AM**

Complex Script Font: +Body CS (Latha), 11 pt

**Page 5: [164] Formatted** **Dave Lommen** **24/09/2018 10:00:00 AM**

Complex Script Font: +Body CS (Latha), 11 pt

**Page 5: [164] Formatted** **Dave Lommen** **24/09/2018 10:00:00 AM**

Complex Script Font: +Body CS (Latha), 11 pt

**Page 5: [165] Formatted** **Dave Lommen** **24/09/2018 10:00:00 AM**

Complex Script Font: +Body CS (Latha), 11 pt

**Page 5: [165] Formatted** **Dave Lommen** **24/09/2018 10:00:00 AM**

Complex Script Font: +Body CS (Latha), 11 pt

**Page 5: [166] Formatted** **Dave Lommen** **24/09/2018 10:00:00 AM**

Complex Script Font: +Body CS (Latha), 11 pt



**Page 5: [166] Formatted** **Dave Lommen** **24/09/2018 10:00:00 AM**

Complex Script Font: +Body CS (Latha), 11 pt

**Page 5: [167] Formatted** **Dave Lommen** **24/09/2018 10:00:00 AM**

Complex Script Font: +Body CS (Latha), 11 pt

**Page 5: [167] Formatted** **Dave Lommen** **24/09/2018 10:00:00 AM**

Complex Script Font: +Body CS (Latha), 11 pt

**Page 5: [168] Formatted** **Dave Lommen** **24/09/2018 10:00:00 AM**

Complex Script Font: +Body CS (Latha), 11 pt

**Page 5: [168] Formatted** **Dave Lommen** **24/09/2018 10:00:00 AM**

Complex Script Font: +Body CS (Latha), 11 pt

**Page 5: [169] Formatted** **Dave Lommen** **24/09/2018 10:00:00 AM**

Complex Script Font: +Body CS (Latha), 11 pt

**Page 5: [169] Formatted** **Dave Lommen** **24/09/2018 10:00:00 AM**

Complex Script Font: +Body CS (Latha), 11 pt

**Page 5: [170] Formatted** **Dave Lommen** **24/09/2018 10:00:00 AM**

Complex Script Font: +Body CS (Latha), 11 pt

**Page 5: [170] Formatted** **Dave Lommen** **24/09/2018 10:00:00 AM**

Complex Script Font: +Body CS (Latha), 11 pt

**Page 5: [171] Formatted** **Dave Lommen** **24/09/2018 10:00:00 AM**

Complex Script Font: +Body CS (Latha), 11 pt

**Page 5: [171] Formatted** **Dave Lommen** **24/09/2018 10:00:00 AM**

Complex Script Font: +Body CS (Latha), 11 pt

**Page 5: [172] Formatted** **Dave Lommen** **24/09/2018 10:00:00 AM**

Complex Script Font: +Body CS (Latha), 11 pt

**Page 5: [172] Formatted** **Dave Lommen** **24/09/2018 10:00:00 AM**

Complex Script Font: +Body CS (Latha), 11 pt

**Page 5: [173] Formatted** **Dave Lommen** **24/09/2018 10:00:00 AM**

Complex Script Font: +Body CS (Latha), 11 pt

**Page 5: [173] Formatted** **Dave Lommen** **24/09/2018 10:00:00 AM**

Complex Script Font: +Body CS (Latha), 11 pt

**Page 5: [174] Formatted** **Dave Lommen** **24/09/2018 10:00:00 AM**

Complex Script Font: +Body CS (Latha), 11 pt

**Page 5: [174] Formatted** **Dave Lommen** **24/09/2018 10:00:00 AM**

Complex Script Font: +Body CS (Latha), 11 pt

**Page 5: [175] Change** **Unknown**

Field Code Changed

**Page 5: [176] Formatted** **Dave Lommen** **24/09/2018 10:00:00 AM**

Complex Script Font: +Body CS (Latha), 11 pt, English (Singapore)

**Page 5: [177] Formatted** **Dave Lommen** **24/09/2018 10:00:00 AM**

Complex Script Font: +Body CS (Latha), 11 pt

**Page 5: [177] Formatted** **Dave Lommen** **24/09/2018 10:00:00 AM**

Complex Script Font: +Body CS (Latha), 11 pt

**Page 5: [178] Formatted** **Dave Lommen** **24/09/2018 10:00:00 AM**

Complex Script Font: +Body CS (Latha), 11 pt

**Page 5: [178] Formatted** **Dave Lommen** **24/09/2018 10:00:00 AM**

Complex Script Font: +Body CS (Latha), 11 pt

**Page 5: [179] Formatted** **Dave Lommen** **24/09/2018 10:00:00 AM**

Complex Script Font: +Body CS (Latha), 11 pt, English (Singapore)

**Page 5: [180] Formatted** **Dave Lommen** **24/09/2018 10:00:00 AM**

Complex Script Font: +Body CS (Latha), 11 pt

**Page 5: [180] Formatted** **Dave Lommen** **24/09/2018 10:00:00 AM**

Complex Script Font: +Body CS (Latha), 11 pt

**Page 5: [181] Formatted** **Dave Lommen** **24/09/2018 10:00:00 AM**

Complex Script Font: +Body CS (Latha), 11 pt, English (Singapore)

**Page 5: [182] Formatted** **Dave Lommen** **24/09/2018 10:00:00 AM**

Complex Script Font: +Body CS (Latha), 11 pt

**Page 5: [182] Formatted** **Dave Lommen** **24/09/2018 10:00:00 AM**

Complex Script Font: +Body CS (Latha), 11 pt

**Page 5: [183] Formatted** **Dave Lommen** **24/09/2018 10:00:00 AM**

Complex Script Font: +Body CS (Latha), 11 pt

**Page 5: [183] Formatted** **Dave Lommen** **24/09/2018 10:00:00 AM**

Complex Script Font: +Body CS (Latha), 11 pt

**Page 5: [184] Formatted** **Dave Lommen** **24/09/2018 10:00:00 AM**

Complex Script Font: +Body CS (Latha), 11 pt

**Page 5: [184] Formatted** **Dave Lommen** **24/09/2018 10:00:00 AM**

Complex Script Font: +Body CS (Latha), 11 pt

**Page 5: [185] Formatted** **Dave Lommen** **24/09/2018 10:00:00 AM**

Complex Script Font: +Body CS (Latha), 11 pt

**Page 5: [185] Formatted** **Dave Lommen** **24/09/2018 10:00:00 AM**

Complex Script Font: +Body CS (Latha), 11 pt

**Page 5: [186] Formatted** **Dave Lommen** **24/09/2018 10:00:00 AM**

Complex Script Font: +Body CS (Latha), 11 pt

**Page 5: [186] Formatted** **Dave Lommen** **24/09/2018 10:00:00 AM**

Complex Script Font: +Body CS (Latha), 11 pt

**Page 5: [187] Formatted** **Dave Lommen** **24/09/2018 10:00:00 AM**

Complex Script Font: +Body CS (Latha), 11 pt

**Page 5: [187] Formatted** **Dave Lommen** **24/09/2018 10:00:00 AM**

Complex Script Font: +Body CS (Latha), 11 pt

**Page 5: [188] Formatted** **Dave Lommen** **24/09/2018 10:00:00 AM**

Complex Script Font: +Body CS (Latha), 11 pt

**Page 5: [188] Formatted** **Dave Lommen** **24/09/2018 10:00:00 AM**

Complex Script Font: +Body CS (Latha), 11 pt

**Page 5: [189] Formatted** **Dave Lommen** **24/09/2018 10:00:00 AM**

Complex Script Font: +Body CS (Latha), 11 pt, English (Singapore)

**Page 5: [190] Formatted** **Dave Lommen** **24/09/2018 10:00:00 AM**

Complex Script Font: +Body CS (Latha), 11 pt

**Page 5: [190] Formatted** **Dave Lommen** **24/09/2018 10:00:00 AM**

Complex Script Font: +Body CS (Latha), 11 pt

**Page 5: [191] Formatted** **Dave Lommen** **24/09/2018 10:00:00 AM**

Complex Script Font: +Body CS (Latha), 11 pt

**Page 5: [191] Formatted** **Dave Lommen** **24/09/2018 10:00:00 AM**

Complex Script Font: +Body CS (Latha), 11 pt

**Page 5: [192] Formatted** **Dave Lommen** **24/09/2018 10:00:00 AM**

Complex Script Font: +Body CS (Latha), 11 pt

**Page 5: [192] Formatted** **Dave Lommen** **24/09/2018 10:00:00 AM**

Complex Script Font: +Body CS (Latha), 11 pt

**Page 5: [193] Formatted** **Dave Lommen** **24/09/2018 10:00:00 AM**

Complex Script Font: +Body CS (Latha), 11 pt

**Page 5: [193] Formatted** **Dave Lommen** **24/09/2018 10:00:00 AM**

Complex Script Font: +Body CS (Latha), 11 pt

**Page 5: [194] Formatted** **Dave Lommen** **24/09/2018 10:00:00 AM**

Complex Script Font: +Body CS (Latha), 11 pt

**Page 5: [194] Formatted** **Dave Lommen** **24/09/2018 10:00:00 AM**

Complex Script Font: +Body CS (Latha), 11 pt

**Page 5: [195] Formatted** **Dave Lommen** **24/09/2018 10:00:00 AM**

Complex Script Font: +Body CS (Latha), 11 pt

**Page 5: [195] Formatted** **Dave Lommen** **24/09/2018 10:00:00 AM**

Complex Script Font: +Body CS (Latha), 11 pt

**Page 5: [196] Formatted** **Dave Lommen** **24/09/2018 10:00:00 AM**

Complex Script Font: +Body CS (Latha), 11 pt

**Page 5: [196] Formatted** **Dave Lommen** **24/09/2018 10:00:00 AM**

Complex Script Font: +Body CS (Latha), 11 pt

**Page 5: [197] Formatted** **Dave Lommen** **24/09/2018 10:00:00 AM**

Complex Script Font: +Body CS (Latha), 11 pt

**Page 5: [197] Formatted** **Dave Lommen** **24/09/2018 10:00:00 AM**

Complex Script Font: +Body CS (Latha), 11 pt

**Page 5: [198] Formatted** **Dave Lommen** **24/09/2018 10:00:00 AM**

Complex Script Font: +Body CS (Latha), 11 pt

**Page 5: [198] Formatted** **Dave Lommen** **24/09/2018 10:00:00 AM**

Complex Script Font: +Body CS (Latha), 11 pt

**Page 5: [199] Formatted** **Dave Lommen** **24/09/2018 10:00:00 AM**

Complex Script Font: +Body CS (Latha), 11 pt

**Page 5: [199] Formatted** **Dave Lommen** **24/09/2018 10:00:00 AM**

Complex Script Font: +Body CS (Latha), 11 pt

**Page 5: [200] Formatted** **Dave Lommen** **24/09/2018 10:00:00 AM**

Complex Script Font: +Body CS (Latha), 11 pt

**Page 5: [200] Formatted** **Dave Lommen** **24/09/2018 10:00:00 AM**

Complex Script Font: +Body CS (Latha), 11 pt

**Page 5: [201] Formatted** **Dave Lommen** **24/09/2018 10:00:00 AM**

Complex Script Font: +Body CS (Latha), 11 pt

**Page 5: [201] Formatted** **Dave Lommen** **24/09/2018 10:00:00 AM**

Complex Script Font: +Body CS (Latha), 11 pt

**Page 5: [201] Formatted** **Dave Lommen** **24/09/2018 10:00:00 AM**

Complex Script Font: +Body CS (Latha), 11 pt

**Page 5: [202] Formatted** **Dave Lommen** **24/09/2018 10:00:00 AM**

Complex Script Font: +Body CS (Latha), 11 pt

**Page 5: [202] Formatted** **Dave Lommen** **24/09/2018 10:00:00 AM**

Complex Script Font: +Body CS (Latha), 11 pt

**Page 5: [203] Formatted** **Dave Lommen** **24/09/2018 10:00:00 AM**

Complex Script Font: +Body CS (Latha), 11 pt

**Page 5: [203] Formatted** **Dave Lommen** **24/09/2018 10:00:00 AM**

Complex Script Font: +Body CS (Latha), 11 pt

**Page 5: [204] Formatted** **Dave Lommen** **24/09/2018 10:00:00 AM**

Complex Script Font: +Body CS (Latha), 11 pt

**Page 5: [204] Formatted** **Dave Lommen** **24/09/2018 10:00:00 AM**

Complex Script Font: +Body CS (Latha), 11 pt

**Page 5: [205] Formatted** **Dave Lommen** **24/09/2018 10:00:00 AM**

Complex Script Font: +Body CS (Latha), 11 pt

**Page 5: [205] Formatted** **Dave Lommen** **24/09/2018 10:00:00 AM**

Complex Script Font: +Body CS (Latha), 11 pt

**Page 5: [206] Formatted** **Dave Lommen** **24/09/2018 10:00:00 AM**

Complex Script Font: +Body CS (Latha), 11 pt

**Page 5: [206] Formatted** **Dave Lommen** **24/09/2018 10:00:00 AM**

Complex Script Font: +Body CS (Latha), 11 pt

**Page 6: [207] Change** **Unknown**

Field Code Changed

**Page 6: [208] Formatted** **Dave Lommen** **24/09/2018 10:00:00 AM**

Complex Script Font: +Body CS (Latha), 11 pt

**Page 6: [208] Formatted** **Dave Lommen** **24/09/2018 10:00:00 AM**

Complex Script Font: +Body CS (Latha), 11 pt

<b>Page 6: [209] Formatted</b>	<b>Dave Lommen</b>	<b>24/09/2018 10:00:00 AM</b>
--------------------------------	--------------------	-------------------------------

Complex Script Font: +Body CS (Latha), 11 pt

<b>Page 6: [209] Formatted</b>	<b>Dave Lommen</b>	<b>24/09/2018 10:00:00 AM</b>
--------------------------------	--------------------	-------------------------------

Complex Script Font: +Body CS (Latha), 11 pt

<b>Page 6: [210] Change</b>	<b>Unknown</b>	
-----------------------------	----------------	--

Field Code Changed

<b>Page 6: [211] Formatted</b>	<b>Dave Lommen</b>	<b>24/09/2018 10:00:00 AM</b>
--------------------------------	--------------------	-------------------------------

Complex Script Font: +Body CS (Latha), 11 pt

<b>Page 6: [211] Formatted</b>	<b>Dave Lommen</b>	<b>24/09/2018 10:00:00 AM</b>
--------------------------------	--------------------	-------------------------------

Complex Script Font: +Body CS (Latha), 11 pt

<b>Page 6: [212] Formatted</b>	<b>Dave Lommen</b>	<b>24/09/2018 10:00:00 AM</b>
--------------------------------	--------------------	-------------------------------

Complex Script Font: +Body CS (Latha), 11 pt

<b>Page 6: [212] Formatted</b>	<b>Dave Lommen</b>	<b>24/09/2018 10:00:00 AM</b>
--------------------------------	--------------------	-------------------------------

Complex Script Font: +Body CS (Latha), 11 pt

<b>Page 6: [213] Formatted</b>	<b>Dave Lommen</b>	<b>24/09/2018 10:00:00 AM</b>
--------------------------------	--------------------	-------------------------------

Complex Script Font: +Body CS (Latha), 11 pt

<b>Page 6: [213] Formatted</b>	<b>Dave Lommen</b>	<b>24/09/2018 10:00:00 AM</b>
--------------------------------	--------------------	-------------------------------

Complex Script Font: +Body CS (Latha), 11 pt

<b>Page 6: [214] Change</b>	<b>Unknown</b>	
-----------------------------	----------------	--

Field Code Changed

<b>Page 6: [215] Formatted</b>	<b>Dave Lommen</b>	<b>24/09/2018 10:00:00 AM</b>
--------------------------------	--------------------	-------------------------------

Complex Script Font: +Body CS (Latha), 11 pt, English (Singapore)

<b>Page 6: [216] Formatted</b>	<b>Dave Lommen</b>	<b>24/09/2018 10:00:00 AM</b>
--------------------------------	--------------------	-------------------------------

Complex Script Font: +Body CS (Latha), 11 pt

<b>Page 6: [216] Formatted</b>	<b>Dave Lommen</b>	<b>24/09/2018 10:00:00 AM</b>
--------------------------------	--------------------	-------------------------------

Complex Script Font: +Body CS (Latha), 11 pt

<b>Page 6: [217] Formatted</b>	<b>Dave Lommen</b>	<b>24/09/2018 10:00:00 AM</b>
--------------------------------	--------------------	-------------------------------

Complex Script Font: +Body CS (Latha), 11 pt

<b>Page 6: [217] Formatted</b>	<b>Dave Lommen</b>	<b>24/09/2018 10:00:00 AM</b>
--------------------------------	--------------------	-------------------------------

Complex Script Font: +Body CS (Latha), 11 pt

<b>Page 6: [218] Formatted</b>	<b>Dave Lommen</b>	<b>24/09/2018 10:00:00 AM</b>
--------------------------------	--------------------	-------------------------------

Complex Script Font: +Body CS (Latha), 11 pt, English (Singapore)

**Page 6: [219] Formatted** **Dave Lommen** **24/09/2018 10:00:00 AM**

Complex Script Font: +Body CS (Latha), 11 pt

**Page 6: [219] Formatted** **Dave Lommen** **24/09/2018 10:00:00 AM**

Complex Script Font: +Body CS (Latha), 11 pt

**Page 6: [220] Formatted** **Dave Lommen** **24/09/2018 10:00:00 AM**

Complex Script Font: +Body CS (Latha), 11 pt, English (Singapore)

**Page 6: [221] Formatted** **Dave Lommen** **24/09/2018 10:00:00 AM**

Complex Script Font: +Body CS (Latha), 11 pt

**Page 6: [221] Formatted** **Dave Lommen** **24/09/2018 10:00:00 AM**

Complex Script Font: +Body CS (Latha), 11 pt

**Page 6: [222] Formatted** **Dave Lommen** **24/09/2018 10:00:00 AM**

Complex Script Font: +Body CS (Latha), 11 pt

**Page 6: [222] Formatted** **Dave Lommen** **24/09/2018 10:00:00 AM**

Complex Script Font: +Body CS (Latha), 11 pt

**Page 6: [223] Formatted** **Dave Lommen** **24/09/2018 10:00:00 AM**

Complex Script Font: +Body CS (Latha), 11 pt

**Page 6: [223] Formatted** **Dave Lommen** **24/09/2018 10:00:00 AM**

Complex Script Font: +Body CS (Latha), 11 pt

**Page 6: [224] Formatted** **Dave Lommen** **24/09/2018 10:00:00 AM**

Complex Script Font: +Body CS (Latha), 11 pt

**Page 6: [224] Formatted** **Dave Lommen** **24/09/2018 10:00:00 AM**

Complex Script Font: +Body CS (Latha), 11 pt

**Page 6: [225] Formatted** **Dave Lommen** **24/09/2018 10:00:00 AM**

Complex Script Font: +Body CS (Latha), 11 pt

**Page 6: [225] Formatted** **Dave Lommen** **24/09/2018 10:00:00 AM**

Complex Script Font: +Body CS (Latha), 11 pt

**Page 6: [226] Formatted** **Dave Lommen** **24/09/2018 10:00:00 AM**

Complex Script Font: +Body CS (Latha), 11 pt

**Page 6: [226] Formatted** **Dave Lommen** **24/09/2018 10:00:00 AM**

Complex Script Font: +Body CS (Latha), 11 pt

**Page 6: [227] Formatted** **Dave Lommen** **24/09/2018 10:00:00 AM**

Complex Script Font: +Body CS (Latha), 11 pt

**Page 6: [227] Formatted** **Dave Lommen** **24/09/2018 10:00:00 AM**

Complex Script Font: +Body CS (Latha), 11 pt

**Page 6: [228] Formatted** **Dave Lommen** **24/09/2018 10:00:00 AM**

Complex Script Font: +Body CS (Latha), 11 pt

**Page 6: [228] Formatted** **Dave Lommen** **24/09/2018 10:00:00 AM**

Complex Script Font: +Body CS (Latha), 11 pt

**Page 6: [229] Formatted** **Dave Lommen** **24/09/2018 10:00:00 AM**

Complex Script Font: +Body CS (Latha), 11 pt

**Page 6: [229] Formatted** **Dave Lommen** **24/09/2018 10:00:00 AM**

Complex Script Font: +Body CS (Latha), 11 pt

**Page 6: [230] Formatted** **Dave Lommen** **24/09/2018 10:00:00 AM**

Complex Script Font: +Body CS (Latha), 11 pt

**Page 6: [230] Formatted** **Dave Lommen** **24/09/2018 10:00:00 AM**

Complex Script Font: +Body CS (Latha), 11 pt

**Page 6: [231] Formatted** **Dave Lommen** **24/09/2018 10:00:00 AM**

Complex Script Font: +Body CS (Latha), 11 pt

**Page 6: [231] Formatted** **Dave Lommen** **24/09/2018 10:00:00 AM**

Complex Script Font: +Body CS (Latha), 11 pt

**Page 6: [232] Formatted** **Dave Lommen** **24/09/2018 10:00:00 AM**

Complex Script Font: +Body CS (Latha), 11 pt

**Page 6: [232] Formatted** **Dave Lommen** **24/09/2018 10:00:00 AM**

Complex Script Font: +Body CS (Latha), 11 pt

**Page 6: [233] Formatted** **Dave Lommen** **24/09/2018 10:00:00 AM**

Complex Script Font: +Body CS (Latha), 11 pt

**Page 6: [233] Formatted** **Dave Lommen** **24/09/2018 10:00:00 AM**

Complex Script Font: +Body CS (Latha), 11 pt

**Page 6: [234] Formatted** **Dave Lommen** **24/09/2018 10:00:00 AM**

Complex Script Font: +Body CS (Latha), 11 pt

**Page 6: [234] Formatted** **Dave Lommen** **24/09/2018 10:00:00 AM**

Complex Script Font: +Body CS (Latha), 11 pt

**Page 6: [235] Formatted** **Dave Lommen** **24/09/2018 10:00:00 AM**

Complex Script Font: +Body CS (Latha), 11 pt



**Page 6: [235] Formatted** Dave Lommen 24/09/2018 10:00:00 AM

Complex Script Font: +Body CS (Latha), 11 pt

**Page 6: [236] Formatted** Dave Lommen 24/09/2018 10:00:00 AM

Complex Script Font: +Body CS (Latha), 11 pt

**Page 6: [236] Formatted** Dave Lommen 24/09/2018 10:00:00 AM

Complex Script Font: +Body CS (Latha), 11 pt

**Page 6: [237] Formatted** Dave Lommen 24/09/2018 10:00:00 AM

Complex Script Font: +Body CS (Latha), 11 pt

**Page 6: [237] Formatted** Dave Lommen 24/09/2018 10:00:00 AM

Complex Script Font: +Body CS (Latha), 11 pt

**Page 6: [238] Formatted** Dave Lommen 24/09/2018 10:00:00 AM

Complex Script Font: +Body CS (Latha), 11 pt

**Page 6: [238] Formatted** Dave Lommen 24/09/2018 10:00:00 AM

Complex Script Font: +Body CS (Latha), 11 pt

**Page 6: [239] Formatted** Dave Lommen 24/09/2018 10:00:00 AM

Complex Script Font: +Body CS (Latha), 11 pt

**Page 6: [239] Formatted** Dave Lommen 24/09/2018 10:00:00 AM

Complex Script Font: +Body CS (Latha), 11 pt

**Page 6: [240] Formatted** Dave Lommen 24/09/2018 10:00:00 AM

Complex Script Font: +Body CS (Latha), 11 pt

**Page 6: [240] Formatted** Dave Lommen 24/09/2018 10:00:00 AM

Complex Script Font: +Body CS (Latha), 11 pt

**Page 6: [241] Formatted** Dave Lommen 24/09/2018 10:00:00 AM

Complex Script Font: +Body CS (Latha), 11 pt

**Page 6: [241] Formatted** Dave Lommen 24/09/2018 10:00:00 AM

Complex Script Font: +Body CS (Latha), 11 pt

**Page 6: [242] Formatted** Dave Lommen 24/09/2018 10:00:00 AM

Complex Script Font: +Body CS (Latha), 11 pt

**Page 6: [242] Formatted** Dave Lommen 24/09/2018 10:00:00 AM

Complex Script Font: +Body CS (Latha), 11 pt

**Page 6: [243] Formatted** Dave Lommen 24/09/2018 10:00:00 AM

Complex Script Font: +Body CS (Latha), 11 pt

**Page 6: [243] Formatted** **Dave Lommen** **24/09/2018 10:00:00 AM**

Complex Script Font: +Body CS (Latha), 11 pt

**Page 6: [244] Formatted** **Dave Lommen** **24/09/2018 10:00:00 AM**

Complex Script Font: +Body CS (Latha), 11 pt

**Page 6: [244] Formatted** **Dave Lommen** **24/09/2018 10:00:00 AM**

Complex Script Font: +Body CS (Latha), 11 pt

**Page 6: [245] Formatted** **Dave Lommen** **24/09/2018 10:00:00 AM**

Complex Script Font: +Body CS (Latha), 11 pt

**Page 6: [246] Formatted** **Dave Lommen** **24/09/2018 10:00:00 AM**

Complex Script Font: +Body CS (Latha), 11 pt

**Page 6: [246] Formatted** **Dave Lommen** **24/09/2018 10:00:00 AM**

Complex Script Font: +Body CS (Latha), 11 pt

**Page 6: [246] Formatted** **Dave Lommen** **24/09/2018 10:00:00 AM**

Complex Script Font: +Body CS (Latha), 11 pt

**Page 6: [247] Formatted** **Dave Lommen** **24/09/2018 10:00:00 AM**

Complex Script Font: +Body CS (Latha), 11 pt

**Page 6: [248] Formatted** **Dave Lommen** **24/09/2018 10:00:00 AM**

Complex Script Font: +Body CS (Latha), 11 pt

**Page 6: [248] Formatted** **Dave Lommen** **24/09/2018 10:00:00 AM**

Complex Script Font: +Body CS (Latha), 11 pt

**Page 6: [248] Formatted** **Dave Lommen** **24/09/2018 10:00:00 AM**

Complex Script Font: +Body CS (Latha), 11 pt

**Page 6: [248] Formatted** **Dave Lommen** **24/09/2018 10:00:00 AM**

Complex Script Font: +Body CS (Latha), 11 pt

**Page 6: [248] Formatted** **Dave Lommen** **24/09/2018 10:00:00 AM**

Complex Script Font: +Body CS (Latha), 11 pt

**Page 6: [248] Formatted** **Dave Lommen** **24/09/2018 10:00:00 AM**

Complex Script Font: +Body CS (Latha), 11 pt

**Page 6: [248] Formatted** **Dave Lommen** **24/09/2018 10:00:00 AM**

Complex Script Font: +Body CS (Latha), 11 pt

**Page 6: [249] Formatted** **Dave Lommen** **24/09/2018 10:00:00 AM**

Complex Script Font: +Body CS (Latha), 11 pt

**Page 6: [249] Formatted** **Dave Lommen** **24/09/2018 10:00:00 AM**

Complex Script Font: +Body CS (Latha), 11 pt

**Page 6: [250] Formatted** **Dave Lommen** **24/09/2018 10:00:00 AM**

Complex Script Font: +Body CS (Latha), 11 pt

**Page 6: [250] Formatted** **Dave Lommen** **24/09/2018 10:00:00 AM**

Complex Script Font: +Body CS (Latha), 11 pt

**Page 6: [251] Formatted** **Dave Lommen** **24/09/2018 10:00:00 AM**

Complex Script Font: +Body CS (Latha), 11 pt

**Page 6: [251] Formatted** **Dave Lommen** **24/09/2018 10:00:00 AM**

Complex Script Font: +Body CS (Latha), 11 pt

**Page 6: [252] Formatted** **Dave Lommen** **24/09/2018 10:00:00 AM**

Complex Script Font: +Body CS (Latha), 11 pt

**Page 6: [253] Formatted** **Dave Lommen** **24/09/2018 10:00:00 AM**

Complex Script Font: +Body CS (Latha), 11 pt

**Page 6: [253] Formatted** **Dave Lommen** **24/09/2018 10:00:00 AM**

Complex Script Font: +Body CS (Latha), 11 pt

**Page 6: [253] Formatted** **Dave Lommen** **24/09/2018 10:00:00 AM**

Complex Script Font: +Body CS (Latha), 11 pt

**Page 6: [254] Formatted** **Dave Lommen** **24/09/2018 10:00:00 AM**

Complex Script Font: +Body CS (Latha), 11 pt

**Page 6: [255] Formatted** **Dave Lommen** **24/09/2018 10:00:00 AM**

Complex Script Font: +Body CS (Latha), 11 pt

**Page 6: [255] Formatted** **Dave Lommen** **24/09/2018 10:00:00 AM**

Complex Script Font: +Body CS (Latha), 11 pt

**Page 6: [255] Formatted** **Dave Lommen** **24/09/2018 10:00:00 AM**

Complex Script Font: +Body CS (Latha), 11 pt

**Page 6: [255] Formatted** **Dave Lommen** **24/09/2018 10:00:00 AM**

Complex Script Font: +Body CS (Latha), 11 pt

**Page 6: [255] Formatted** **Dave Lommen** **24/09/2018 10:00:00 AM**

Complex Script Font: +Body CS (Latha), 11 pt

**Page 6: [255] Formatted** **Dave Lommen** **24/09/2018 10:00:00 AM**

Complex Script Font: +Body CS (Latha), 11 pt

**Page 6: [255] Formatted** **Dave Lommen** **24/09/2018 10:00:00 AM**

Complex Script Font: +Body CS (Latha), 11 pt

**Page 6: [256] Formatted** **Dave Lommen** **24/09/2018 10:00:00 AM**

Complex Script Font: +Body CS (Latha), 11 pt

**Page 6: [257] Formatted** **Dave Lommen** **24/09/2018 10:00:00 AM**

Complex Script Font: +Body CS (Latha), 11 pt

**Page 6: [257] Formatted** **Dave Lommen** **24/09/2018 10:00:00 AM**

Complex Script Font: +Body CS (Latha), 11 pt

**Page 6: [257] Formatted** **Dave Lommen** **24/09/2018 10:00:00 AM**

Complex Script Font: +Body CS (Latha), 11 pt

**Page 6: [257] Formatted** **Dave Lommen** **24/09/2018 10:00:00 AM**

Complex Script Font: +Body CS (Latha), 11 pt

**Page 6: [257] Formatted** **Dave Lommen** **24/09/2018 10:00:00 AM**

Complex Script Font: +Body CS (Latha), 11 pt

**Page 6: [257] Formatted** **Dave Lommen** **24/09/2018 10:00:00 AM**

Complex Script Font: +Body CS (Latha), 11 pt

**Page 6: [257] Formatted** **Dave Lommen** **24/09/2018 10:00:00 AM**

Complex Script Font: +Body CS (Latha), 11 pt

**Page 6: [257] Formatted** **Dave Lommen** **24/09/2018 10:00:00 AM**

Complex Script Font: +Body CS (Latha), 11 pt

**Page 6: [257] Formatted** **Dave Lommen** **24/09/2018 10:00:00 AM**

Complex Script Font: +Body CS (Latha), 11 pt

**Page 6: [257] Formatted** **Dave Lommen** **24/09/2018 10:00:00 AM**

Complex Script Font: +Body CS (Latha), 11 pt

**Page 6: [258] Formatted** **Dave Lommen** **24/09/2018 10:00:00 AM**

Complex Script Font: +Body CS (Latha), 11 pt

**Page 6: [258] Formatted** **Dave Lommen** **24/09/2018 10:00:00 AM**

Complex Script Font: +Body CS (Latha), 11 pt

**Page 6: [259] Formatted** **Dave Lommen** **24/09/2018 10:00:00 AM**

Complex Script Font: +Body CS (Latha), 11 pt

**Page 6: [259] Formatted** **Dave Lommen** **24/09/2018 10:00:00 AM**

Complex Script Font: +Body CS (Latha), 11 pt

**Page 6: [260] Formatted** **Dave Lommen** **24/09/2018 10:00:00 AM**

Complex Script Font: +Body CS (Latha), 11 pt

**Page 6: [260] Formatted** **Dave Lommen** **24/09/2018 10:00:00 AM**

Complex Script Font: +Body CS (Latha), 11 pt

**Page 6: [261] Formatted** **Dave Lommen** **24/09/2018 10:00:00 AM**

Complex Script Font: +Body CS (Latha), 11 pt

**Page 6: [261] Formatted** **Dave Lommen** **24/09/2018 10:00:00 AM**

Complex Script Font: +Body CS (Latha), 11 pt

**Page 6: [262] Formatted** **Dave Lommen** **24/09/2018 10:00:00 AM**

Complex Script Font: +Body CS (Latha), 11 pt

**Page 6: [262] Formatted** **Dave Lommen** **24/09/2018 10:00:00 AM**

Complex Script Font: +Body CS (Latha), 11 pt

**Page 6: [263] Formatted** **Dave Lommen** **24/09/2018 10:00:00 AM**

Complex Script Font: +Body CS (Latha), 11 pt

**Page 6: [263] Formatted** **Dave Lommen** **24/09/2018 10:00:00 AM**

Complex Script Font: +Body CS (Latha), 11 pt

**Page 6: [264] Formatted** **Dave Lommen** **24/09/2018 10:00:00 AM**

Complex Script Font: +Body CS (Latha), 11 pt

**Page 6: [264] Formatted** **Dave Lommen** **24/09/2018 10:00:00 AM**

Complex Script Font: +Body CS (Latha), 11 pt

**Page 6: [265] Formatted** **Dave Lommen** **24/09/2018 10:00:00 AM**

Complex Script Font: +Body CS (Latha), 11 pt

**Page 6: [265] Formatted** **Dave Lommen** **24/09/2018 10:00:00 AM**

Complex Script Font: +Body CS (Latha), 11 pt

**Page 6: [266] Formatted** **Dave Lommen** **24/09/2018 10:00:00 AM**

Complex Script Font: +Body CS (Latha), 11 pt

**Page 6: [266] Formatted** **Dave Lommen** **24/09/2018 10:00:00 AM**

Complex Script Font: +Body CS (Latha), 11 pt

**Page 6: [267] Formatted** **Dave Lommen** **24/09/2018 10:00:00 AM**

Complex Script Font: +Body CS (Latha), 11 pt

**Page 6: [267] Formatted** **Dave Lommen** **24/09/2018 10:00:00 AM**

Complex Script Font: +Body CS (Latha), 11 pt

**Page 6: [268] Formatted** **Dave Lommen** **24/09/2018 10:00:00 AM**

Complex Script Font: +Body CS (Latha), 11 pt

**Page 6: [268] Formatted** **Dave Lommen** **24/09/2018 10:00:00 AM**

Complex Script Font: +Body CS (Latha), 11 pt

**Page 7: [269] Formatted** **Dave Lommen** **24/09/2018 10:00:00 AM**

Complex Script Font: +Body CS (Latha), 11 pt

**Page 7: [269] Formatted** **Dave Lommen** **24/09/2018 10:00:00 AM**

Complex Script Font: +Body CS (Latha), 11 pt

**Page 7: [270] Formatted** **Dave Lommen** **24/09/2018 10:00:00 AM**

Complex Script Font: +Body CS (Latha), 11 pt

**Page 7: [270] Formatted** **Dave Lommen** **24/09/2018 10:00:00 AM**

Complex Script Font: +Body CS (Latha), 11 pt

**Page 7: [271] Formatted** **Dave Lommen** **24/09/2018 10:00:00 AM**

Complex Script Font: +Body CS (Latha), 11 pt

**Page 7: [271] Formatted** **Dave Lommen** **24/09/2018 10:00:00 AM**

Complex Script Font: +Body CS (Latha), 11 pt

**Page 7: [272] Formatted** **Dave Lommen** **24/09/2018 10:00:00 AM**

Complex Script Font: +Body CS (Latha), 11 pt

**Page 7: [272] Formatted** **Dave Lommen** **24/09/2018 10:00:00 AM**

Complex Script Font: +Body CS (Latha), 11 pt

**Page 7: [273] Formatted** **Dave Lommen** **24/09/2018 10:00:00 AM**

Complex Script Font: +Body CS (Latha), 11 pt

**Page 7: [273] Formatted** **Dave Lommen** **24/09/2018 10:00:00 AM**

Complex Script Font: +Body CS (Latha), 11 pt

**Page 7: [274] Formatted** **Dave Lommen** **24/09/2018 10:00:00 AM**

Complex Script Font: +Body CS (Latha), 11 pt

**Page 7: [274] Formatted** **Dave Lommen** **24/09/2018 10:00:00 AM**

Complex Script Font: +Body CS (Latha), 11 pt

**Page 7: [275] Formatted** **Dave Lommen** **24/09/2018 10:00:00 AM**

Complex Script Font: +Body CS (Latha), 11 pt

**Page 7: [275] Formatted** **Dave Lommen** **24/09/2018 10:00:00 AM**

Complex Script Font: +Body CS (Latha), 11 pt

**Page 7: [276] Formatted** **Dave Lommen** **24/09/2018 10:00:00 AM**

Complex Script Font: +Body CS (Latha), 11 pt

**Page 7: [276] Formatted** **Dave Lommen** **24/09/2018 10:00:00 AM**

Complex Script Font: +Body CS (Latha), 11 pt

**Page 7: [277] Formatted** **Dave Lommen** **24/09/2018 10:00:00 AM**

Complex Script Font: +Body CS (Latha), 11 pt

**Page 7: [277] Formatted** **Dave Lommen** **24/09/2018 10:00:00 AM**

Complex Script Font: +Body CS (Latha), 11 pt

**Page 7: [278] Formatted** **Dave Lommen** **24/09/2018 10:00:00 AM**

Complex Script Font: +Body CS (Latha), 11 pt

**Page 7: [278] Formatted** **Dave Lommen** **24/09/2018 10:00:00 AM**

Complex Script Font: +Body CS (Latha), 11 pt

**Page 7: [279] Formatted** **Dave Lommen** **24/09/2018 10:00:00 AM**

Complex Script Font: +Body CS (Latha), 11 pt

**Page 7: [279] Formatted** **Dave Lommen** **24/09/2018 10:00:00 AM**

Complex Script Font: +Body CS (Latha), 11 pt

**Page 7: [280] Formatted** **Dave Lommen** **24/09/2018 10:00:00 AM**

Complex Script Font: +Body CS (Latha), 11 pt

**Page 7: [280] Formatted** **Dave Lommen** **24/09/2018 10:00:00 AM**

Complex Script Font: +Body CS (Latha), 11 pt

**Page 7: [281] Formatted** **Dave Lommen** **24/09/2018 10:00:00 AM**

Complex Script Font: +Body CS (Latha), 11 pt

**Page 7: [281] Formatted** **Dave Lommen** **24/09/2018 10:00:00 AM**

Complex Script Font: +Body CS (Latha), 11 pt

**Page 7: [282] Formatted** **Dave Lommen** **24/09/2018 10:00:00 AM**

Complex Script Font: +Body CS (Latha), 11 pt

**Page 7: [282] Formatted** **Dave Lommen** **24/09/2018 10:00:00 AM**

Complex Script Font: +Body CS (Latha), 11 pt

**Page 7: [283] Formatted** **Dave Lommen** **24/09/2018 10:00:00 AM**

Complex Script Font: +Body CS (Latha), 11 pt

**Page 7: [283] Formatted** **Dave Lommen** **24/09/2018 10:00:00 AM**

Complex Script Font: +Body CS (Latha), 11 pt

**Page 7: [284] Formatted** **Dave Lommen** **24/09/2018 10:00:00 AM**

Complex Script Font: +Body CS (Latha), 11 pt

**Page 7: [284] Formatted** **Dave Lommen** **24/09/2018 10:00:00 AM**

Complex Script Font: +Body CS (Latha), 11 pt

**Page 7: [285] Formatted** **Dave Lommen** **24/09/2018 10:00:00 AM**

Complex Script Font: +Body CS (Latha), 11 pt

**Page 7: [285] Formatted** **Dave Lommen** **24/09/2018 10:00:00 AM**

Complex Script Font: +Body CS (Latha), 11 pt

**Page 7: [286] Formatted** **Dave Lommen** **24/09/2018 10:00:00 AM**

Complex Script Font: +Body CS (Latha), 11 pt

**Page 7: [286] Formatted** **Dave Lommen** **24/09/2018 10:00:00 AM**

Complex Script Font: +Body CS (Latha), 11 pt

**Page 7: [287] Formatted** **Dave Lommen** **24/09/2018 10:00:00 AM**

Complex Script Font: +Body CS (Latha), 11 pt

**Page 7: [287] Formatted** **Dave Lommen** **24/09/2018 10:00:00 AM**

Complex Script Font: +Body CS (Latha), 11 pt

**Page 7: [288] Formatted** **Dave Lommen** **24/09/2018 10:00:00 AM**

Complex Script Font: +Body CS (Latha)

**Page 7: [288] Formatted** **Dave Lommen** **24/09/2018 10:00:00 AM**

Complex Script Font: +Body CS (Latha)

**Page 7: [289] Formatted** **Dave Lommen** **24/09/2018 10:00:00 AM**

Complex Script Font: +Body CS (Latha)

**Page 7: [289] Formatted** **Dave Lommen** **24/09/2018 10:00:00 AM**

Complex Script Font: +Body CS (Latha)

**Page 7: [290] Formatted** **Dave Lommen** **24/09/2018 10:00:00 AM**

Complex Script Font: +Body CS (Latha)

**Page 7: [290] Formatted** **Dave Lommen** **24/09/2018 10:00:00 AM**

Complex Script Font: +Body CS (Latha)

**Page 7: [291] Formatted** **Dave Lommen** **24/09/2018 10:00:00 AM**

Complex Script Font: +Body CS (Latha)

**Page 7: [291] Formatted** **Dave Lommen** **24/09/2018 10:00:00 AM**

Complex Script Font: +Body CS (Latha)



**Page 7: [292] Formatted** **Dave Lommen** **24/09/2018 10:00:00 AM**

Complex Script Font: +Body CS (Latha)

**Page 7: [292] Formatted** **Dave Lommen** **24/09/2018 10:00:00 AM**

Complex Script Font: +Body CS (Latha)

**Page 7: [293] Formatted** **Dave Lommen** **24/09/2018 10:00:00 AM**

Complex Script Font: +Body CS (Latha)

**Page 7: [293] Formatted** **Dave Lommen** **24/09/2018 10:00:00 AM**

Complex Script Font: +Body CS (Latha)

**Page 7: [294] Formatted** **Dave Lommen** **24/09/2018 10:00:00 AM**

Complex Script Font: +Body CS (Latha)

**Page 7: [294] Formatted** **Dave Lommen** **24/09/2018 10:00:00 AM**

Complex Script Font: +Body CS (Latha)

**Page 7: [295] Formatted** **Dave Lommen** **24/09/2018 10:00:00 AM**

Complex Script Font: +Body CS (Latha)

**Page 7: [295] Formatted** **Dave Lommen** **24/09/2018 10:00:00 AM**

Complex Script Font: +Body CS (Latha)

**Page 7: [296] Formatted** **Dave Lommen** **24/09/2018 10:00:00 AM**

Complex Script Font: +Body CS (Latha)

**Page 7: [296] Formatted** **Dave Lommen** **24/09/2018 10:00:00 AM**

Complex Script Font: +Body CS (Latha)

**Page 7: [297] Formatted** **Dave Lommen** **24/09/2018 10:00:00 AM**

Complex Script Font: +Body CS (Latha)

**Page 7: [297] Formatted** **Dave Lommen** **24/09/2018 10:00:00 AM**

Complex Script Font: +Body CS (Latha)

**Page 7: [298] Formatted** **Dave Lommen** **24/09/2018 10:00:00 AM**

Complex Script Font: +Body CS (Latha)

**Page 7: [298] Formatted** **Dave Lommen** **24/09/2018 10:00:00 AM**

Complex Script Font: +Body CS (Latha)

**Page 7: [299] Formatted** **Dave Lommen** **24/09/2018 10:00:00 AM**

Complex Script Font: +Body CS (Latha)

**Page 7: [299] Formatted** **Dave Lommen** **24/09/2018 10:00:00 AM**

Complex Script Font: +Body CS (Latha)

**Page 7: [300] Formatted** **Dave Lommen** **24/09/2018 10:00:00 AM**

Complex Script Font: +Body CS (Latha)

**Page 7: [300] Formatted** **Dave Lommen** **24/09/2018 10:00:00 AM**

Complex Script Font: +Body CS (Latha)

**Page 7: [301] Formatted** **Dave Lommen** **24/09/2018 10:00:00 AM**

Complex Script Font: +Body CS (Latha)

**Page 7: [301] Formatted** **Dave Lommen** **24/09/2018 10:00:00 AM**

Complex Script Font: +Body CS (Latha)

**Page 8: [302] Formatted** **Dave Lommen** **24/09/2018 10:00:00 AM**

Complex Script Font: +Body CS (Latha)

**Page 8: [302] Formatted** **Dave Lommen** **24/09/2018 10:00:00 AM**

Complex Script Font: +Body CS (Latha)

**Page 8: [303] Formatted** **Dave Lommen** **24/09/2018 10:00:00 AM**

Complex Script Font: +Body CS (Latha)

**Page 8: [303] Formatted** **Dave Lommen** **24/09/2018 10:00:00 AM**

Complex Script Font: +Body CS (Latha)

**Page 8: [304] Formatted** **Dave Lommen** **24/09/2018 10:00:00 AM**

Complex Script Font: +Body CS (Latha)

**Page 8: [304] Formatted** **Dave Lommen** **24/09/2018 10:00:00 AM**

Complex Script Font: +Body CS (Latha)

**Page 8: [305] Formatted** **Dave Lommen** **24/09/2018 10:00:00 AM**

Complex Script Font: +Body CS (Latha)

**Page 8: [305] Formatted** **Dave Lommen** **24/09/2018 10:00:00 AM**

Complex Script Font: +Body CS (Latha)

**Page 8: [306] Formatted** **Dave Lommen** **24/09/2018 10:00:00 AM**

Complex Script Font: +Body CS (Latha)

**Page 8: [306] Formatted** **Dave Lommen** **24/09/2018 10:00:00 AM**

Complex Script Font: +Body CS (Latha)

**Page 8: [307] Formatted** **Dave Lommen** **24/09/2018 10:00:00 AM**

Complex Script Font: +Body CS (Latha)

**Page 8: [307] Formatted** **Dave Lommen** **24/09/2018 10:00:00 AM**

Complex Script Font: +Body CS (Latha)

<b>Page 8: [308] Formatted</b>	<b>Dave Lommen</b>	<b>24/09/2018 10:00:00 AM</b>
--------------------------------	--------------------	-------------------------------

Complex Script Font: +Body CS (Latha)

<b>Page 8: [308] Formatted</b>	<b>Dave Lommen</b>	<b>24/09/2018 10:00:00 AM</b>
--------------------------------	--------------------	-------------------------------

Complex Script Font: +Body CS (Latha)

<b>Page 8: [309] Formatted</b>	<b>Dave Lommen</b>	<b>24/09/2018 10:00:00 AM</b>
--------------------------------	--------------------	-------------------------------

Complex Script Font: +Body CS (Latha)

<b>Page 8: [309] Formatted</b>	<b>Dave Lommen</b>	<b>24/09/2018 10:00:00 AM</b>
--------------------------------	--------------------	-------------------------------

Complex Script Font: +Body CS (Latha)

<b>Page 8: [310] Formatted</b>	<b>Dave Lommen</b>	<b>24/09/2018 10:00:00 AM</b>
--------------------------------	--------------------	-------------------------------

Complex Script Font: +Body CS (Latha)

<b>Page 8: [310] Formatted</b>	<b>Dave Lommen</b>	<b>24/09/2018 10:00:00 AM</b>
--------------------------------	--------------------	-------------------------------

Complex Script Font: +Body CS (Latha)

<b>Page 8: [311] Formatted</b>	<b>Dave Lommen</b>	<b>24/09/2018 10:00:00 AM</b>
--------------------------------	--------------------	-------------------------------

Complex Script Font: +Body CS (Latha)

<b>Page 8: [311] Formatted</b>	<b>Dave Lommen</b>	<b>24/09/2018 10:00:00 AM</b>
--------------------------------	--------------------	-------------------------------

Complex Script Font: +Body CS (Latha)

<b>Page 8: [312] Formatted</b>	<b>Dave Lommen</b>	<b>24/09/2018 10:00:00 AM</b>
--------------------------------	--------------------	-------------------------------

Complex Script Font: +Body CS (Latha)

<b>Page 8: [312] Formatted</b>	<b>Dave Lommen</b>	<b>24/09/2018 10:00:00 AM</b>
--------------------------------	--------------------	-------------------------------

Complex Script Font: +Body CS (Latha)

<b>Page 8: [313] Formatted</b>	<b>Dave Lommen</b>	<b>24/09/2018 10:00:00 AM</b>
--------------------------------	--------------------	-------------------------------

Complex Script Font: +Body CS (Latha)

<b>Page 8: [313] Formatted</b>	<b>Dave Lommen</b>	<b>24/09/2018 10:00:00 AM</b>
--------------------------------	--------------------	-------------------------------

Complex Script Font: +Body CS (Latha)

<b>Page 8: [314] Formatted</b>	<b>Dave Lommen</b>	<b>24/09/2018 10:00:00 AM</b>
--------------------------------	--------------------	-------------------------------

Complex Script Font: +Body CS (Latha)

<b>Page 8: [314] Formatted</b>	<b>Dave Lommen</b>	<b>24/09/2018 10:00:00 AM</b>
--------------------------------	--------------------	-------------------------------

Complex Script Font: +Body CS (Latha)

<b>Page 8: [315] Formatted</b>	<b>Dave Lommen</b>	<b>24/09/2018 10:00:00 AM</b>
--------------------------------	--------------------	-------------------------------

Complex Script Font: +Body CS (Latha)

<b>Page 8: [315] Formatted</b>	<b>Dave Lommen</b>	<b>24/09/2018 10:00:00 AM</b>
--------------------------------	--------------------	-------------------------------

Complex Script Font: +Body CS (Latha)

**Page 8: [316] Formatted** **Dave Lommen** **24/09/2018 10:00:00 AM**

Complex Script Font: +Body CS (Latha)

**Page 8: [316] Formatted** **Dave Lommen** **24/09/2018 10:00:00 AM**

Complex Script Font: +Body CS (Latha)

**Page 8: [316] Formatted** **Dave Lommen** **24/09/2018 10:00:00 AM**

Complex Script Font: +Body CS (Latha)

**Page 8: [316] Formatted** **Dave Lommen** **24/09/2018 10:00:00 AM**

Complex Script Font: +Body CS (Latha)

**Page 8: [316] Formatted** **Dave Lommen** **24/09/2018 10:00:00 AM**

Complex Script Font: +Body CS (Latha)

**Page 8: [317] Formatted** **Dave Lommen** **24/09/2018 10:00:00 AM**

Complex Script Font: +Body CS (Latha)

**Page 8: [317] Formatted** **Dave Lommen** **24/09/2018 10:00:00 AM**

Complex Script Font: +Body CS (Latha)

**Page 8: [317] Formatted** **Dave Lommen** **24/09/2018 10:00:00 AM**

Complex Script Font: +Body CS (Latha)

**Page 8: [317] Formatted** **Dave Lommen** **24/09/2018 10:00:00 AM**

Complex Script Font: +Body CS (Latha)

**Page 8: [317] Formatted** **Dave Lommen** **24/09/2018 10:00:00 AM**

Complex Script Font: +Body CS (Latha)

**Page 8: [317] Formatted** **Dave Lommen** **24/09/2018 10:00:00 AM**

Complex Script Font: +Body CS (Latha)

**Page 8: [318] Formatted** **Dave Lommen** **24/09/2018 10:00:00 AM**

Complex Script Font: +Body CS (Latha)

**Page 8: [318] Formatted** **Dave Lommen** **24/09/2018 10:00:00 AM**

Complex Script Font: +Body CS (Latha)

**Page 8: [319] Formatted** **Dave Lommen** **24/09/2018 10:00:00 AM**

Complex Script Font: +Body CS (Latha)

**Page 8: [319] Formatted** **Dave Lommen** **24/09/2018 10:00:00 AM**

Complex Script Font: +Body CS (Latha)

**Page 8: [320] Formatted** **Dave Lommen** **24/09/2018 10:00:00 AM**

Complex Script Font: +Body CS (Latha)

**Page 8: [320] Formatted** **Dave Lommen** **24/09/2018 10:00:00 AM**

Complex Script Font: +Body CS (Latha)

**Page 8: [321] Formatted** **Dave Lommen** **24/09/2018 10:00:00 AM**

Complex Script Font: +Body CS (Latha)

**Page 8: [321] Formatted** **Dave Lommen** **24/09/2018 10:00:00 AM**

Complex Script Font: +Body CS (Latha)

**Page 8: [322] Formatted** **Dave Lommen** **24/09/2018 10:00:00 AM**

Complex Script Font: +Body CS (Latha)

**Page 8: [322] Formatted** **Dave Lommen** **24/09/2018 10:00:00 AM**

Complex Script Font: +Body CS (Latha)

**Page 8: [323] Formatted** **Dave Lommen** **24/09/2018 10:00:00 AM**

Complex Script Font: +Body CS (Latha)

**Page 8: [323] Formatted** **Dave Lommen** **24/09/2018 10:00:00 AM**

Complex Script Font: +Body CS (Latha)

**Page 8: [324] Formatted** **Dave Lommen** **24/09/2018 10:00:00 AM**

Complex Script Font: +Body CS (Latha)

**Page 8: [324] Formatted** **Dave Lommen** **24/09/2018 10:00:00 AM**

Complex Script Font: +Body CS (Latha)

**Page 8: [325] Formatted** **Dave Lommen** **24/09/2018 10:00:00 AM**

Complex Script Font: +Body CS (Latha)

**Page 8: [325] Formatted** **Dave Lommen** **24/09/2018 10:00:00 AM**

Complex Script Font: +Body CS (Latha)