

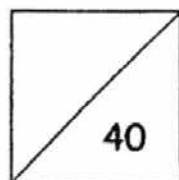

HENRY PARK PRIMARY SCHOOL  
 MATHEMATICS  
 2016 PRIMARY 2 (TERM 2)  
 TOPICAL QUIZ 2



Name: \_\_\_\_\_ (    )

Class: Pr 2 \_\_\_\_\_ Parent's Signature: \_\_\_\_\_

Duration: 55 min

Section A : Multiple Choice Questions (6 x 1 mark = 6 marks)

Choose the correct answer and write its number in the brackets provided.

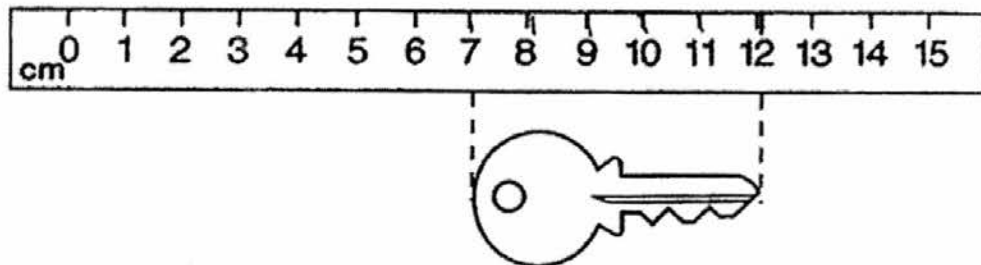

- (1) 5 cm  
 (2) 7 cm  
 (3) 10 cm  
 (4) 12 cm

(    )

2. The length of a spoon is about \_\_\_\_\_.

- (1) 15 m
- (2) 15 cm
- (3) 150 m
- (4) 150 cm

( )

3. Look at the picture below.

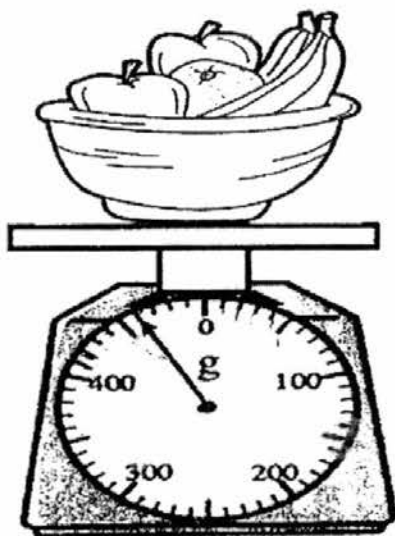

What is the mass of the basket of fruits?

- (1) 406 g
- (2) 460 g
- (3) 510 g
- (4) 560 g

( )

4. What is the mass of the watermelon in the picture shown below?

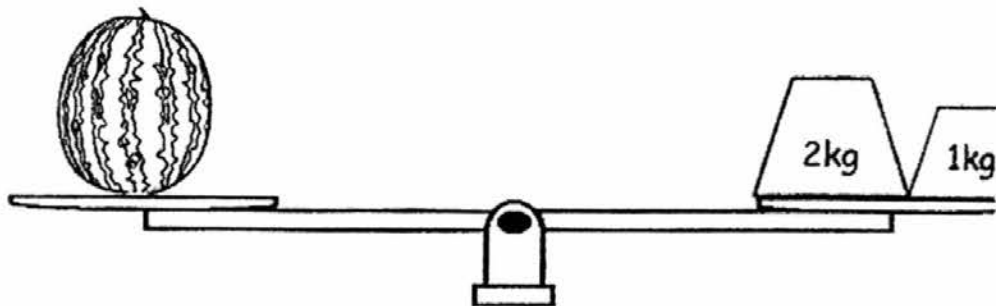

What is the mass of the watermelon in kilograms?

- (1) 6 kg  
(2) 2 kg  
(3) 3 kg  
(4) 4 kg ( )
5. Which is the same as 3 groups of 6?
- (1)  $3 + 6$   
(2)  $3 \times 6$   
(3)  $3 + 3 + 3 + 3 + 3 + 3$   
(4)  $6 + 6 + 6 + 6 + 6 + 6$  ( )
6. 7 twos = \_\_\_\_\_
- (1) 5  
(2) 9  
(3) 14  
(4) 21 ( )

Section B : Open - Ended Questions

Questions 7 to 14 carry 1 mark each. (8 × 1 mark = 8 marks)

Questions 15 to 21 carry 2 marks each. (7 × 2 marks = 14 marks)

Fill in your answers in the boxes provided.

Look at the picture below and answer questions 7 and 8.

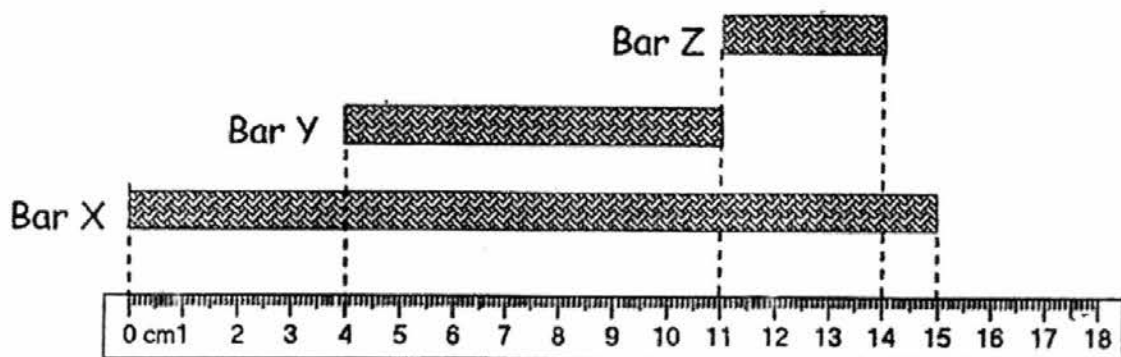

7. What is the length of Bar Y?

8. Bar Z is \_\_\_\_\_ cm shorter than Bar X.

9. Arrange the objects in the boxes shown below according to their masses. Write the names of the objects in the boxes provided, beginning with the heaviest object.

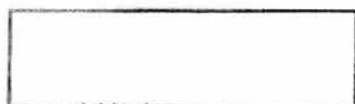
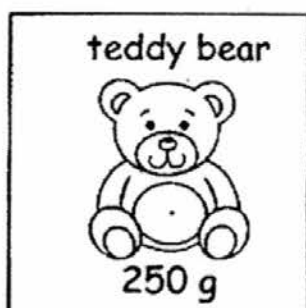

heaviest

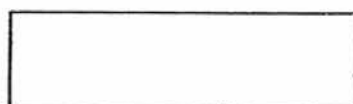
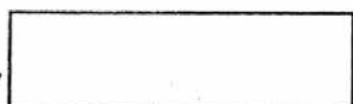

10. The two durians have the same mass. What is the mass of each durian?

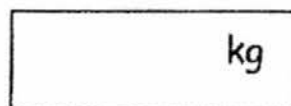
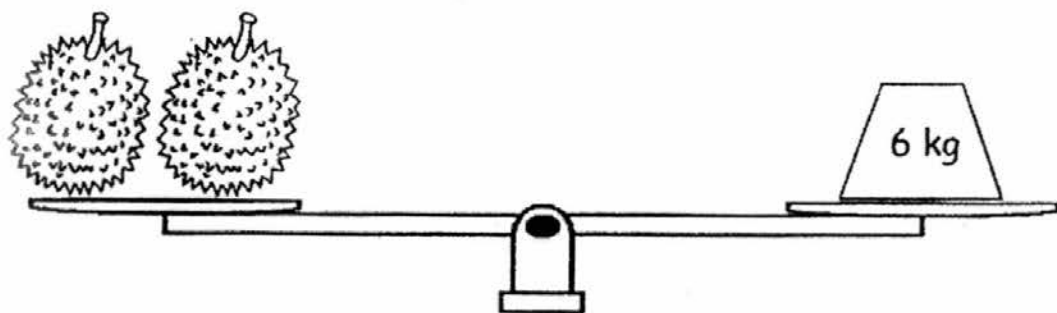

11. Look at the following picture.

Complete the multiplication sentence.

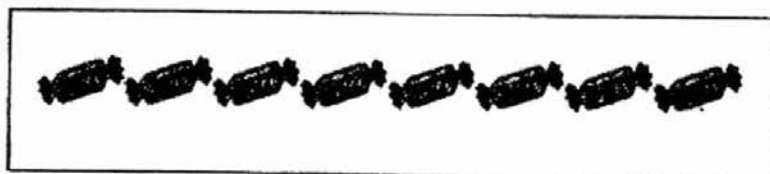
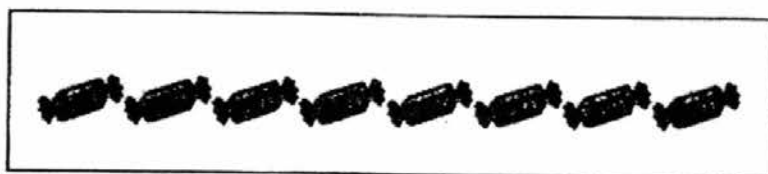

$$\underline{\hspace{2cm}} \times \underline{\hspace{2cm}} = \underline{\hspace{2cm}}$$

12. Look at the following picture.

Complete the division equation.

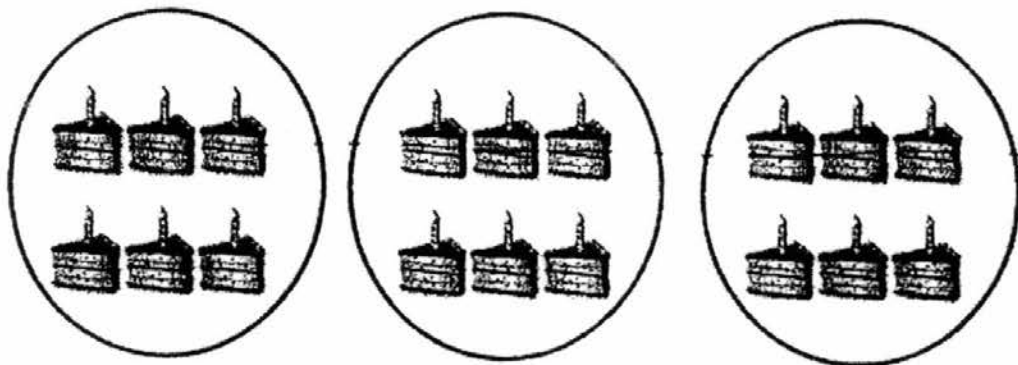

$$\underline{\hspace{2cm}} \div \underline{\hspace{2cm}} = \underline{\hspace{2cm}}$$

13. Fill in the box with 'g' or 'kg'.

The mass of a cat is about 4

14. 5 children share 20 cupcakes equally.

How many cupcakes does each child get?

Circle to show your answer.



15. Alex used 4 rods to form the rectangle below.

What is the total length of the 4 rods?

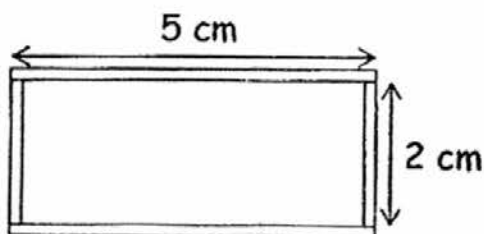
 cm

16. Andy packs a sandwich into his empty lunch box. What is the mass of the sandwich?

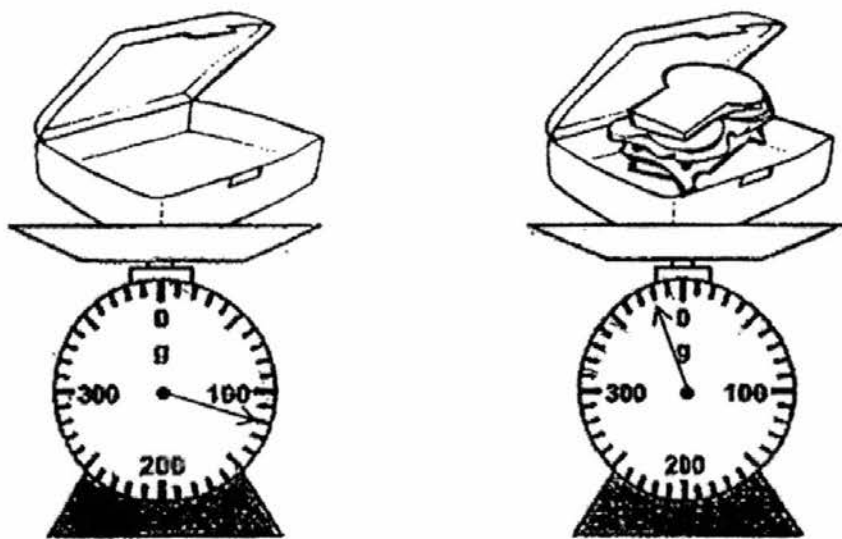

100

200

g

17. Each chicken has 2 legs. How many legs does 7 chickens have?

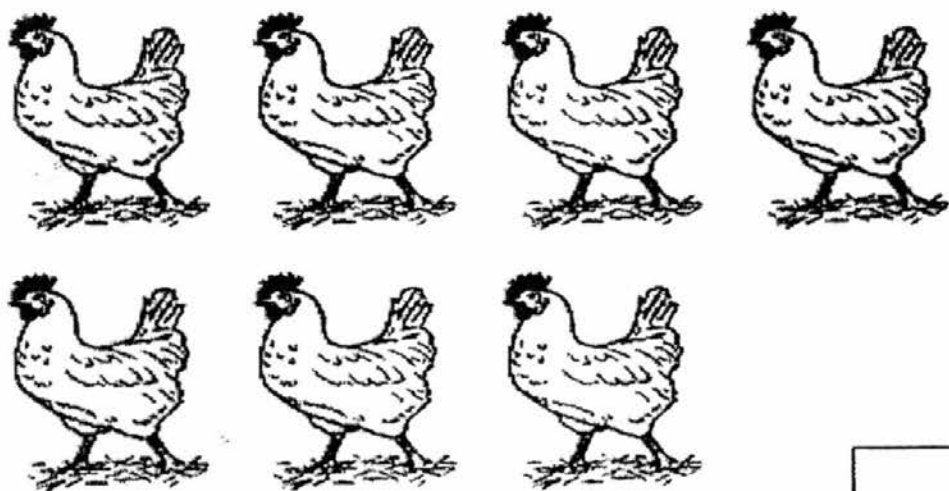

14

legs



18. The chart shows the height of 4 pupils.

Name	Height
Colin	129 cm
Esther	137 cm
David	152 cm
Susan	131 cm

David is taller than the shortest pupil by \_\_\_\_\_ cm.

_____	cm
-------	----

19. Study the pictures below carefully.

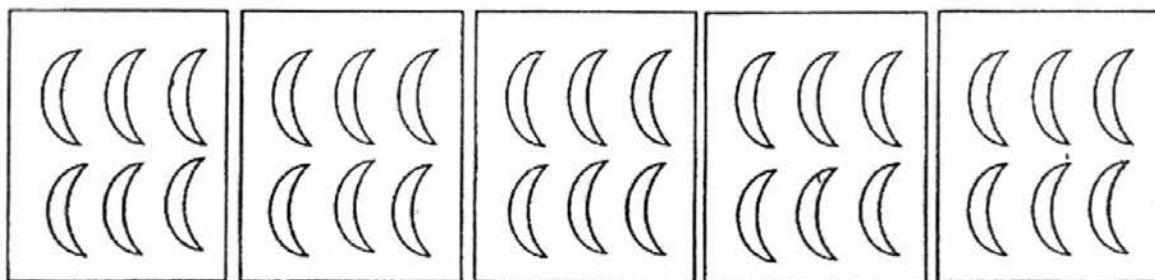

Write one multiplication and one division equation for the picture.

$$\square \times \square = \square$$
$$\square \div \square = \square$$

20. Jane had 15 biscuits. She placed the biscuits equally onto 3 plates.  
How many biscuits were there on each plate?

21. Study the pictures below carefully.

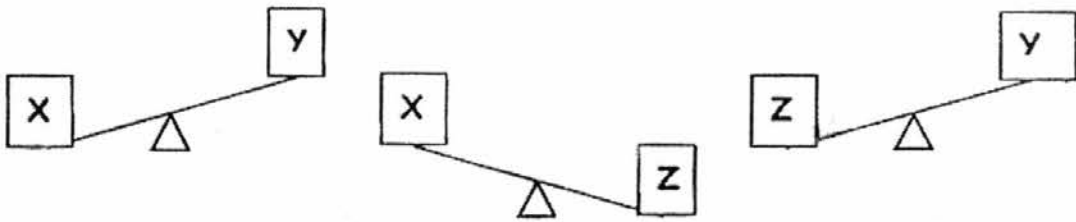

Which box is the lightest?

Section C: Word Problems (3 x 4 marks = 12 marks)

Questions 22 to 24 carry 4 mark each. Read each question carefully.

Show all your Math equations and word statements clearly in the spaces provided.

22. Julie used 325g of flour to bake some cookies.

After baking the cookies, she had 487g of flour left.

How much flour did Julie have at first?

Working

Julie had \_\_\_\_\_  
\_\_\_\_\_

23. Sam collected 32 picture cards.

He arranged the cards equally on 4 pages of an album.

How many cards were there on each page?

There were \_\_\_\_\_  
\_\_\_\_\_

24. Jane is 135 cm tall.

Jane is 28 cm taller than Alice.

How tall is Alice?

Working

Alice is \_\_\_\_\_

---

End of paper

EXAM PAPER 2016 (P2)

SCHOOL : HENRY PARK PRIMARY SCHOOL

SUBJECT : MATHEMATICS

TERM : SA1

Q1	Q2	Q3	Q4	Q5	Q6				
1	2	2	3	2	3				

Q7) 7 cm

Q8) 12 cm

Q9) drum , toy car , teddy bear

Q10) 3 kg

Q11)  $2 \times 8 = 16$

Q12)  $18 \div 3 = 6$

Q13) kg

Q14)

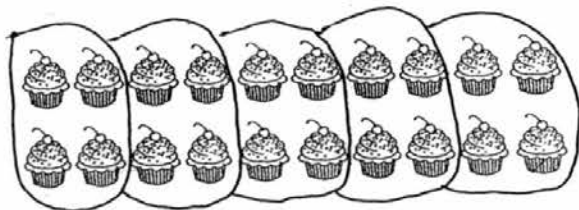

Q15) 14 cm

Q16) 260 g

Q17) 14 legs

Q18) 23 cm

Q19)  $5 \times 6 = 30$

$30 \div 5 = 6$

Q20) 5

Q21) Box Y

Q22)  $487\text{g} + 325\text{g} = 812\text{g}$

Julie had 812g of flour at first.

Q23)  $32 \div 4 = 8$

There were 8 cards in each page.

Q24)  $135 - 28 = 107$

Alice is 107cm tall.