



**RAFFLES GIRLS' PRIMARY SCHOOL  
SEMESTRAL ASSESSMENT 2  
MATHEMATICS  
PRIMARY 3**

Name: \_\_\_\_\_ ( )

Class: P3 \_\_\_\_

Date: 29 October 2009

Duration: 1 h 45 min

<b>Your Score (Out of 100 marks)</b>		
	<b>Class</b>	<b>Level</b>
<b>Highest Score</b>		
<b>Average Score</b>		
<b>Parent's Signature</b>		

**INSTRUCTIONS TO CANDIDATES**

1. Do not turn over this page until you are told to do so.
2. Follow all instructions carefully.
3. Answer ALL questions
4. Write your answers in this booklet and show all working clearly.

**SECTION A (40 marks)**

Question 1 to 20 carry 2 marks each. For each question, four options are given. One of them is the correct answer. Make your choice (1, 2, 3 or 4). Write your answer (1, 2, 3 or 4) in the brackets provided.

---

1. What is 1000 more than 4801?

(1) 3801

(2) 4811

(3) 4901

(4) 5801

(     )

2.

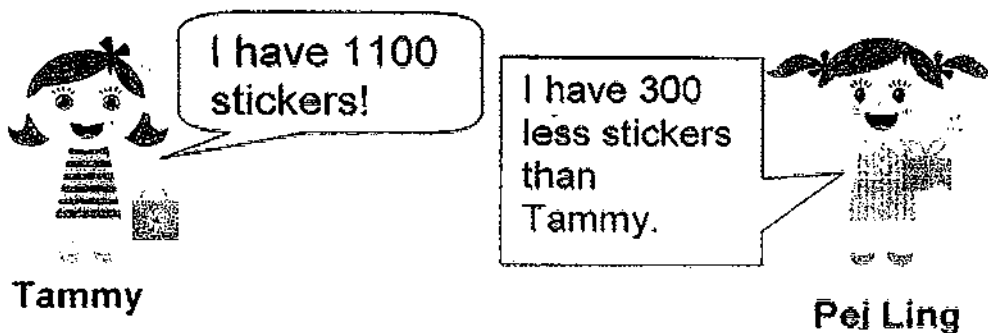

How many stickers do the two girls have altogether?

(1) 800

(2) 1400

(3) 1900

(4) 2500

(     )

3. Express 3 m 9 cm in centimetres.

- (1) 39 cm
- (2) 309 cm
- (3) 390 cm
- (4) 3009 cm

( )

4. The weighing scale below shows the mass of two identical books. What is the mass of 1 such book?

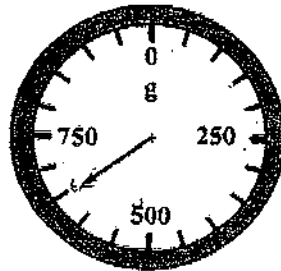

- (1) 300 g
- (2) 325 g
- (3) 600 g
- (4) 650 g

( )

5. What is the volume of the water in the container below?

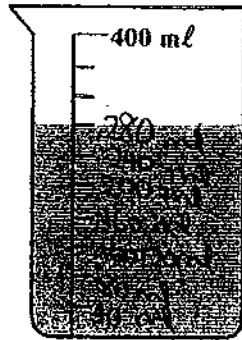

(1) 250 ml

(2) 280 ml

(3) 300 ml

(4) 340 ml

( )

6. Betty has the notes shown below.  
She wants to buy a bicycle that costs \$90.  
How many more five-dollar notes does she need?

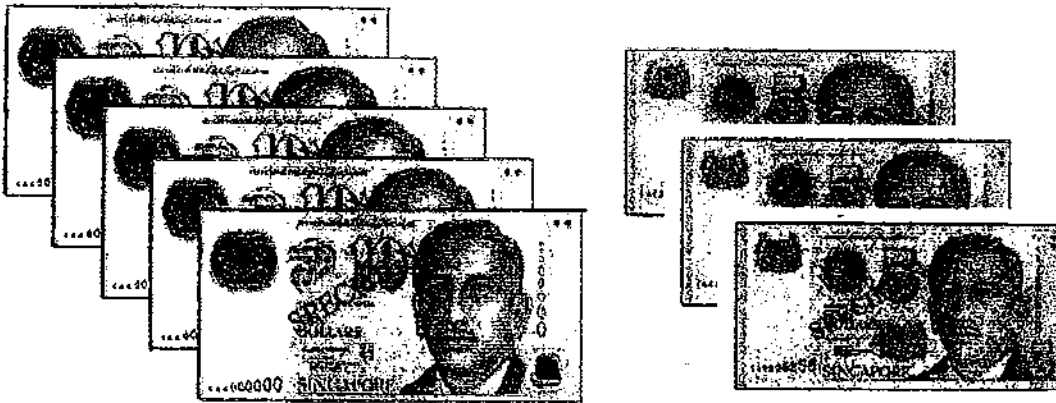

(1) 5

(2) 6

(3) 7

(4) 8

( )

7. The rectangle below is divided into 9 equal parts. What fraction of the rectangle is shaded?

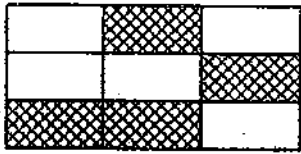

- (1)  $\frac{4}{5}$   
 (2)  $\frac{5}{9}$   
 (3)  $\frac{4}{9}$   
 (4)  $\frac{5}{4}$

( )

8. Which pair of lines are parallel?

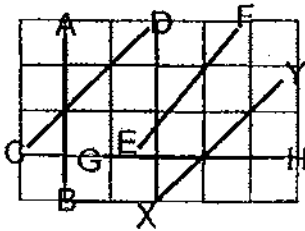

- (1) AB and CD  
 (2) AB and GH  
 (3) XY and EF  
 (4) CD and XY

( )

9. Express 275 minutes in hours and minutes.

- (1) 2 h 75 min  
 (2) 3 h 15 min  
 (3) 4 h 35 min  
 (4) 5 h 25 min

( )

10. The figure below is made up of identical squares. What is the perimeter of the figure?

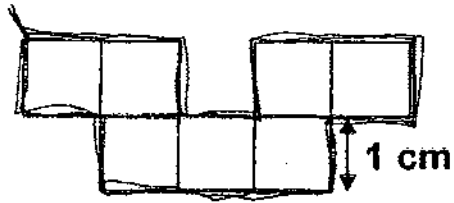

- (1) 13 cm  
(2) 16 cm  
(3) 22 cm  
(4) 28 cm
- ( )
11. Find the sum of 3629 <sup>and</sup> ~~to~~ 5874

- (1) 2245  
(2) 2255  
(3) 9493  
(4) 9503
- ( )

12. Which one of the following number statements will not give you 2 kg?

- (1)  $8 \times 250\text{g}$   
(2)  $1111\text{g} + 889\text{g}$   
(3)  $4 \text{ kg } 50\text{g} - 2500\text{g}$   
(4)  $6000\text{g} \div 3$
- ( )

13. Mr Lee bought a pair of shoes for \$42.50 and 3 pairs of socks at \$3.90 each. He gave the cashier a hundred-dollar note. What was his change?

- (1) \$ 45.80
- (2) \$ 46.40
- (3) \$ 53.60
- (4) \$ 55.80

( )

14. The graph shows the number of tourists at a museum over 5 days.

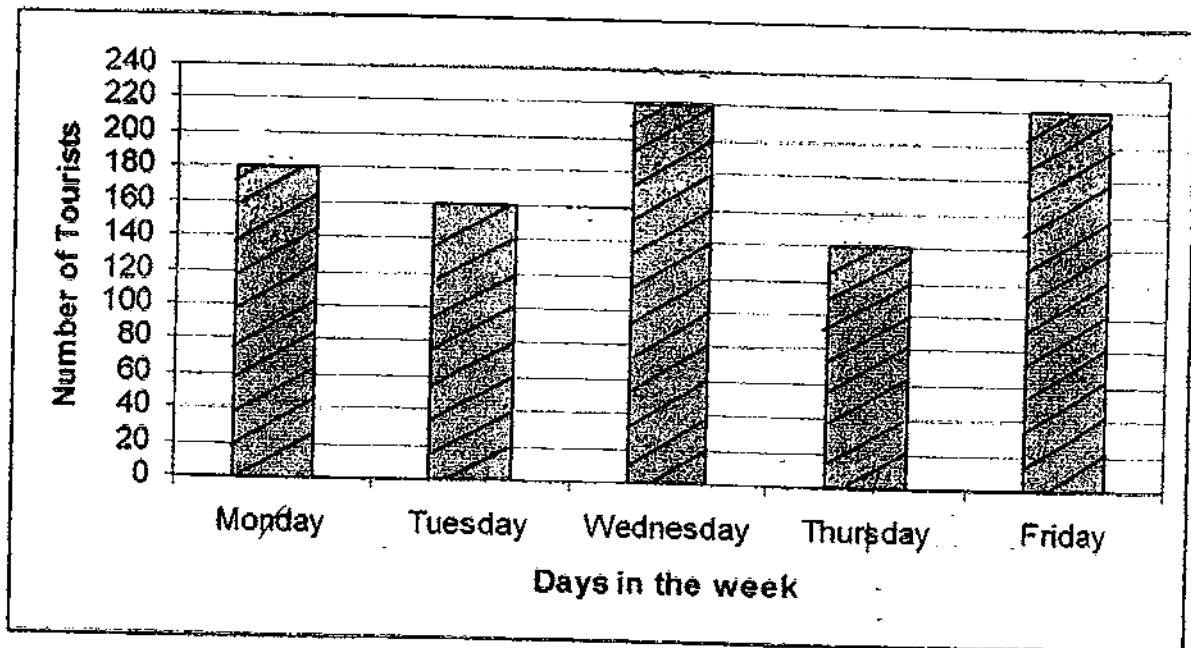

Which two days had a total of 320 tourists visited the museum?

- (1) Monday and Tuesday
- (2) Tuesday and Thursday
- (3) Wednesday and Friday
- (4) Monday and Thursday

( )

15. The figures below are made up of 4 identical squares.

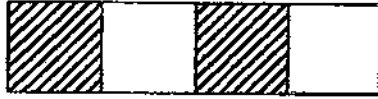

Figure A

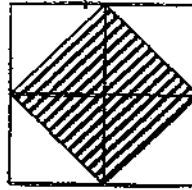

Figure B

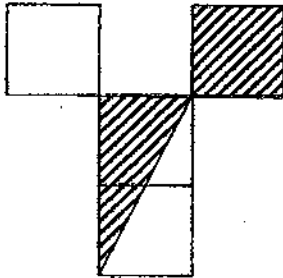

Figure C

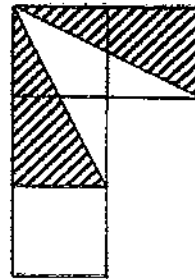

Figure D

Which of the figure(s) above has/have half of it shaded?

- (1) A only
- (2) A and B only
- (3) A, B and C only
- (4) A, B, C and D

( )



16. Beatrice went out at 11.15 a.m. She came home 1 h 15 min later. Which clock below shows the time Beatrice reached home?

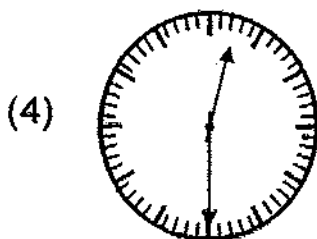
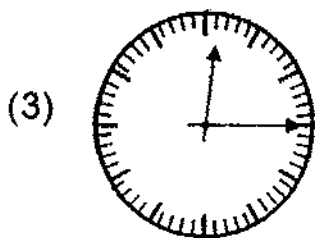
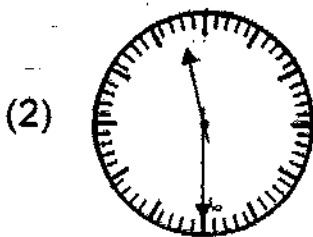
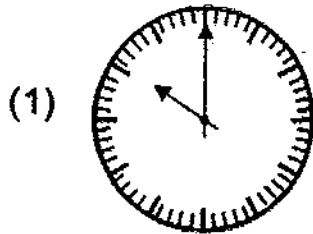

( )

17. Which of the following figures has the smallest area?

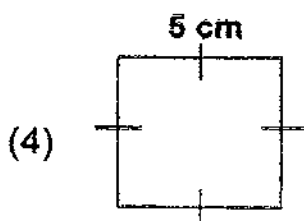
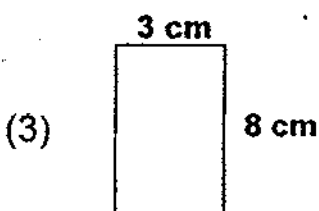
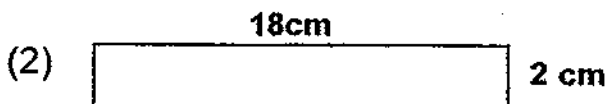
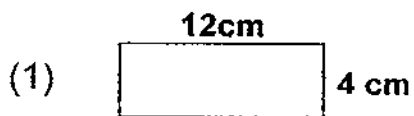

18. What is the quotient when 3056 is divided by 7?

(1) 3063

(2) 3049

(3) 436

(4) 4

19. The school bell will ring once every 30 minutes.  
 How many times will the school bell ring from 7.30 a.m. to  
 1 p.m. including the first ring at 7.30 a.m.?

- (1) 6
- (2) 7
- (3) 11
- (4) 12

( )

20. Five identical square tiles were pasted onto a rectangular  
 wall shown below.  
 What is the perimeter of the shaded part?

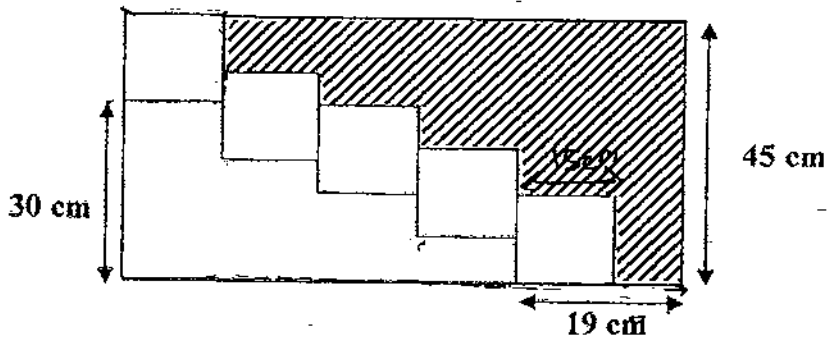

- (1) 114 cm
- (2) 119 cm
- (3) 200 cm
- (4) 218 cm

( )

**SECTION B (40 marks)**

Question 21 to 40 carry 2 marks each. Write your answers in the spaces provided. For questions which require units, give your answers in the units stated. All diagrams are not drawn to scale. Answers in fractions must be expressed in the simplest form. Marks will be awarded for relevant working.

---

21. The digit '3' in 8392 stands for \_\_\_\_\_

Ans: \_\_\_\_\_

22. Find the difference between 1999 and 4907.

Ans: \_\_\_\_\_

23.  $360 \times 8 =$  \_\_\_\_\_

Ans: \_\_\_\_\_

24. Five pupils participated in a 100 m race. The graph below shows the time taken by each of them to complete the race.

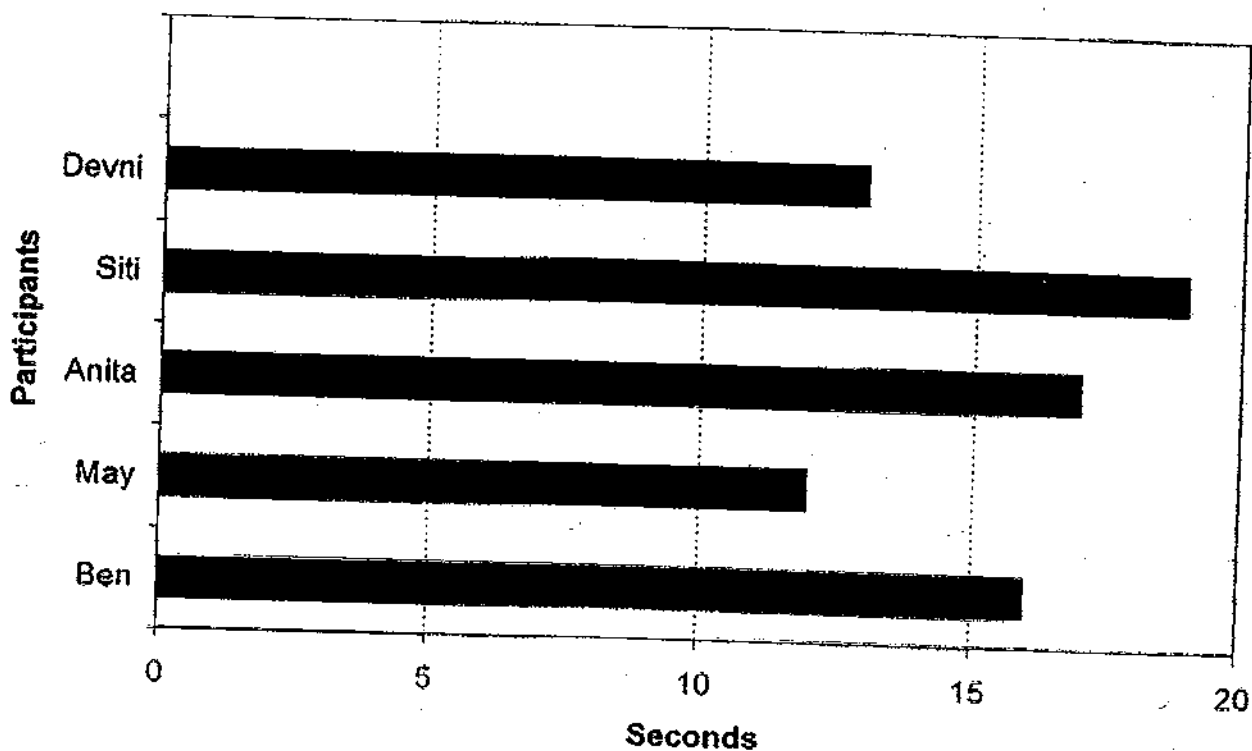

- (a) How many pupils took less than 15 seconds to complete the race?
- (b) Who was the fastest runner?

Ans: (a) \_\_\_\_\_

(b) \_\_\_\_\_

25. Draw a perpendicular line to PQ that passes through the point marked R.

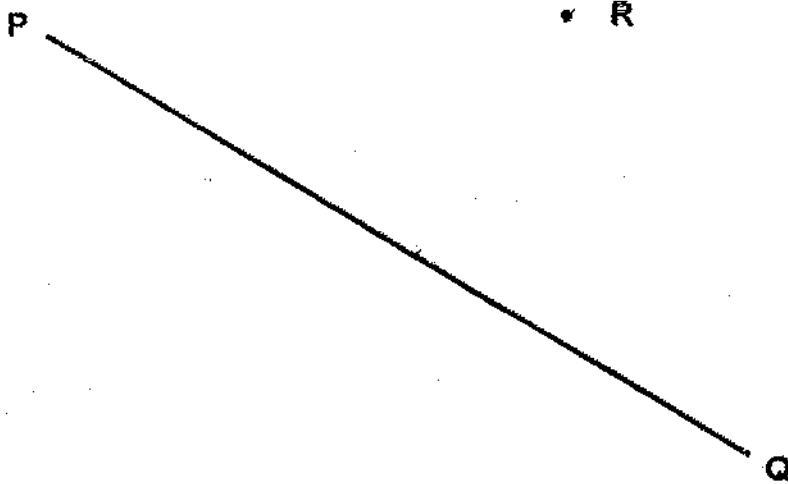

26. Which of the following fractions is the largest?

$$\frac{2}{5}, \frac{1}{2}, \frac{3}{10}$$

Ans: \_\_\_\_\_

27. The length of the rectangle is 3 times its breadth. Find its area.

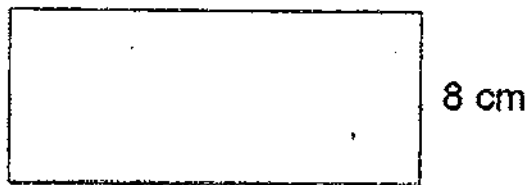

Ans: \_\_\_\_\_ cm<sup>2</sup>

28. Look at the numbers below.  
Form the smallest 4-digit odd number. Each digit can only be used once.



Ans: \_\_\_\_\_

29. A square ABCD of side 30 cm in Figure X is cut into 2 pieces. The pieces are arranged to form a rectangle in Figure Y. Find the breadth of the rectangle in Figure Y.

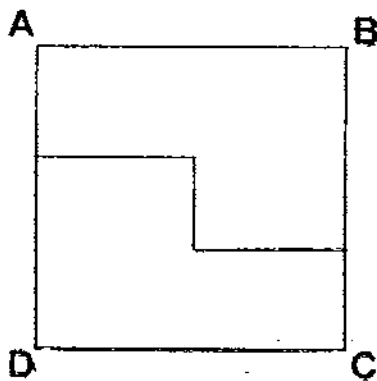

Figure X

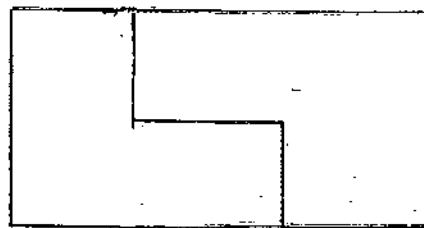
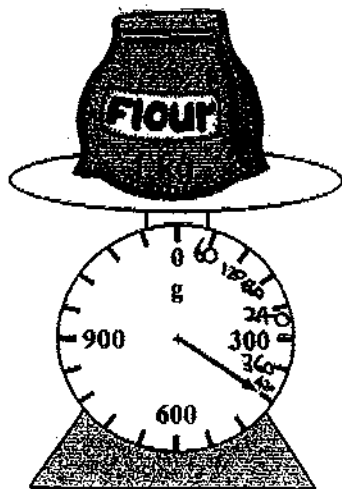

Figure Y

Ans: \_\_\_\_\_ cm

30. Mrs Wong bought 1 kg of flour to bake a cake. After using some flour, she placed the packet of remainder flour on the weighing scale as shown below. How much flour did she use?



Ans: \_\_\_\_\_ g

31. Study the recipe below.

**Ingredients for making  
Peach Tea**

- 1) 50 ml of peach juice
- 2) 1 l 150 ml of tea
- 3) 440 ml of sugar syrup

Ye Min mixed all the ingredients together to make some peach tea. She then poured the peach tea equally into 8 similar cups. What was the volume of peach tea in each cup?

Ans: \_\_\_\_\_ ml



32. Devi had these coins before recess.



After recess, she had these coins left. How much did she spend during recess?



Ans: \$ \_\_\_\_\_

33. The graph below shows the number of pupils in School A and School B who take the school bus to school. The total number of pupils in each school is 1200.

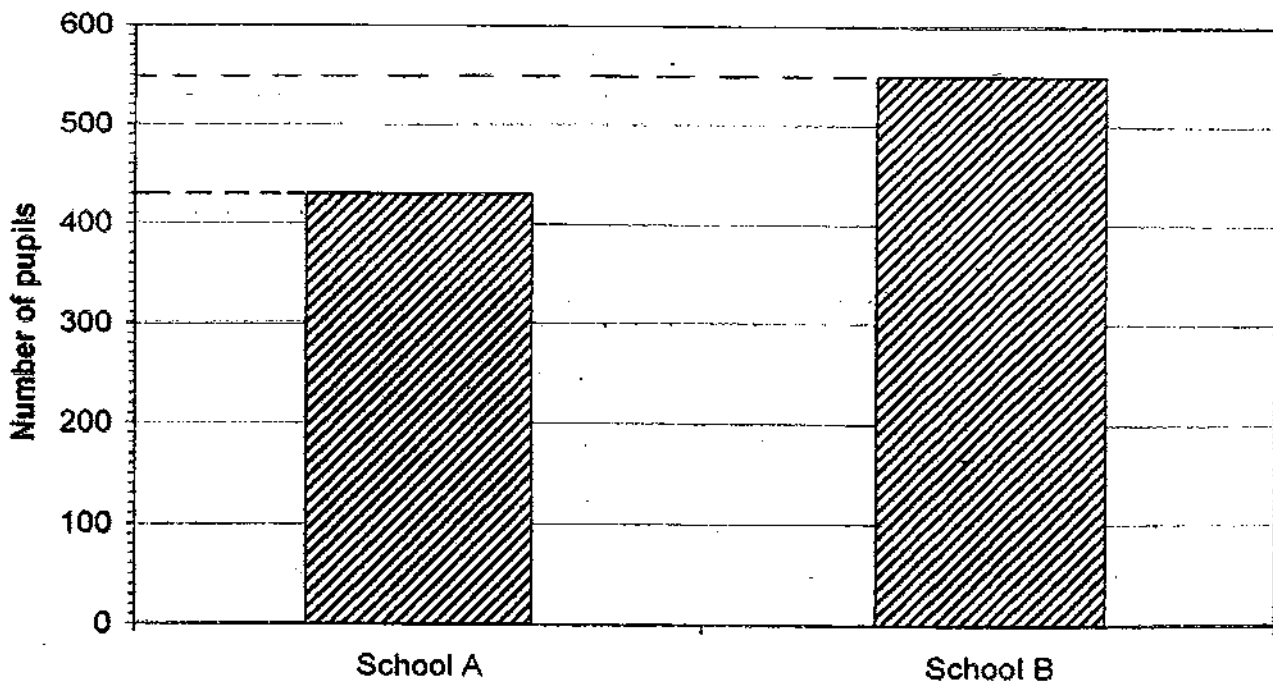

How many pupils do not take school bus to school for School A and School B altogether?

Ans: \_\_\_\_\_

34. Queenie cut a <sup>pizza</sup> ~~mooncake~~ into 8 equal pieces. She gave 2 pieces to her brother and one piece to her sister. She ate  $\frac{1}{8}$  of it. What fraction of the pizza was left? Give your answer in the simplest form.

Ans: \_\_\_\_\_

35. Study the figure below and fill in the blanks with the correct answer.



- a) There are \_\_\_\_\_ right angles.  
 b) There are \_\_\_\_\_ angles smaller than a right angle.

36. Complete the number pattern. What is the value of A?

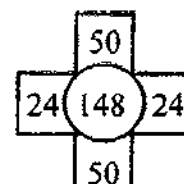
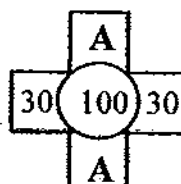
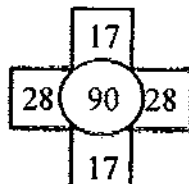
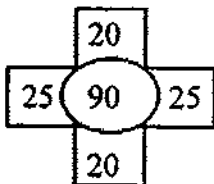

Ans: \_\_\_\_\_

37. On Saturday, 3047 soccer match tickets were sold.  
849 fewer soccer tickets were sold on Sunday than on Saturday.  
How many soccer tickets were sold on both days?

Ans: \_\_\_\_\_





38.

$$\clubsuit \times \clubsuit \times \clubsuit = 27$$
$$\heartsuit + \heartsuit + \heartsuit = 15$$

What is  $\clubsuit \times \heartsuit$  ?

Ans: \_\_\_\_\_

39.

 apple - 50 cents each	 milk -\$2.30 per packet
 pineapple juice - \$0.70 per can	 biscuits - \$1.45 per packet

Minah bought 4 apples and a packet of milk.  
 Her sister bought 3 cans of pineapple juice and a packet of biscuits.  
 How much more did Minah spend?

Ans: \$ \_\_\_\_\_

40.



1 out of 10 equal parts in a rectangle is shaded. Fiona wants to shade  $\frac{3}{5}$  of the rectangle. How many more equal parts must she shade?

Ans: \_\_\_\_\_

**SECTION C (20 marks)**

For question 41 to 46, show your working clearly in the space provided below each question and write your answer with suitable units in the spaces provided. All diagrams are not drawn to scale. Answers in fractions must be expressed in the simplest form. Marks will be awarded for relevant working. The number of marks available is shown in brackets [ ] at the end of each question or part-question.

---

41. Mrs Chew left her house at 3.15 p.m. to go to the hair salon. She reached the hair salon 20 minutes later and waited for her haircut. If she left the salon at 15 minutes past 4, how long did Mrs Chew spend in the hair salon?

Ans: \_\_\_\_\_ [3]

42. Mr Lim made 340 fishballs.  
He packed them into boxes of 10 fishballs.
- How many boxes did he use?
  - He sold each box for \$2. But he collected only \$60 and had some boxes of fishballs left. How many fishballs had he left?

Ans: (a) \_\_\_\_\_ [1]

(b) \_\_\_\_\_ [3]

43. Some flower pots were placed at equal distances apart along a street.
- The distance between the first and the third flower pots was 6 m.  
If the distance between the first and the last flower pot was 90 m,  
how many flower pots were there altogether along the street?

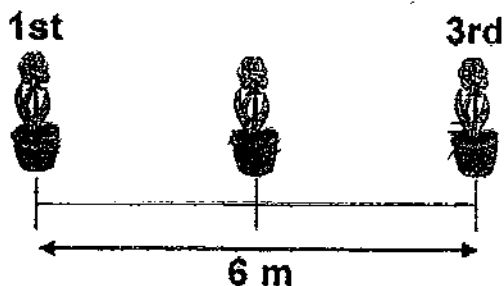

Ans: \_\_\_\_\_ [3]

44. A farmer had goats and ostriches in his farm.  
He found that there were 80 heads and 224 legs in all.  
How many ostriches were there in the farm?



goat



ostrich

Ans: \_\_\_\_\_ [4]

45. Mr Lim sold some apples, oranges and mangoes in a day.  
The number of apples sold was twice the number of mangoes sold.  
 $\frac{4}{7}$  of the fruits sold were oranges.  
How many fruits had Mr Lim sold in a day if he sold 24 apples in a day?

Ans: \_\_\_\_\_ [3]

46. Devi had some \$2 notes and \$5 notes.  
She had a total of \$76.  
She had 4 more \$5 notes than \$2 notes.  
How many \$2 notes did she have?

Ans: \_\_\_\_\_ [3]

**-End of Paper-**  
**Please check your work carefully ☺**

Setters: Tan CP & Cheng KH





# ANSWER SHEET

**EXAM PAPER 2009**

**SCHOOL : RAFFLES GIRLS' PRIMARY  
SUBJECT : PRIMARY 3 MATHEMATICS**

**TERM : SA2**

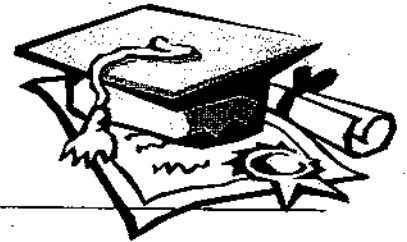

Q1	Q2	Q3	Q4	Q5	Q6	Q7	Q8	Q9	Q10	Q11	Q12	Q13	Q14	Q15	Q16	Q17
4	3	2	2	2	1	3	4	3	2	4	3	1	4	4	4	3

Q18	Q19	Q20	Q21	Q22	Q23
3	4	4	300	2908	2880

24)a)2 b)May

28)3457 29)20cm

30)580g 31)205ml

32)\$1.54 33)1420

34)  $\frac{1}{2}$  35)a)2 b)4

39)\$0.75 40)5

41)25min+15min=40min

44)2x80=160  
224-160=64  
4-2=2  
64÷2=32  
80-32=48

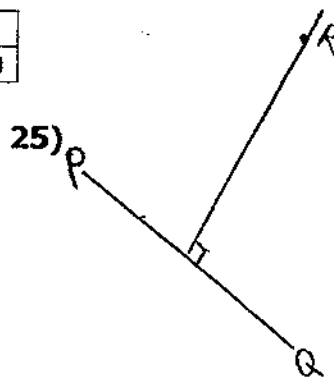

26)  $\frac{1}{2}$  27)193cm<sup>2</sup>

36)20

37)5345

38)15

42)a)340÷10=34

b)34x2=68

68-60=8

8÷2=4

4x10=40

43) 6÷2=3

90÷3=30

30+1=31

45)24÷2=12

12x7=84

46)4x5=20

76-20=56

5+2=7

56÷7=8