

METHODIST GIRLS' SCHOOL (PRIMARY)
CONTINUAL ASSESSEMENT 2, 2004
PRIMARY 4 - SCIENCE

CA

NAME : _____ CLASS: PR 4 _____

SECTION A (30 MARKS)
CHOOSE THE CORRECT ANSWER AND WRITE ITS NUMBER IN THE
BRACKETS PROVIDED.

1. Study the flow chart below.

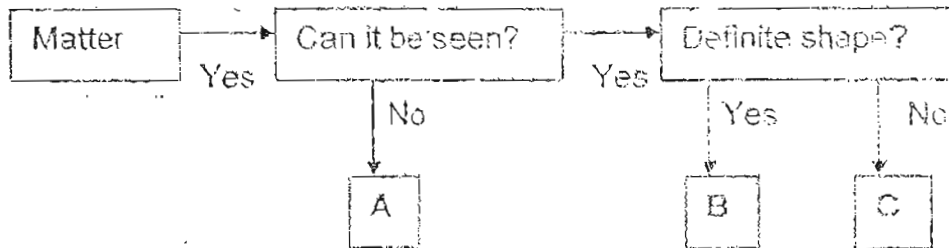

What are A, B and C likely to be?

A	B	C
1. Shadow	Chair	Water
2. Steam	Table	Milk
3. Oxygen	Cup	Nitrogen
4. Heat	Ruler	Coffee

()

2. Which one of the following changes takes place when a piece of candle is heated for some time?

- 1) Liquid → solid → gas
- 2) Solid → gas → liquid
- 3) Solid → liquid → gas
- 4) Liquid → gas → solid

()

3. Which one of the following does not have mass and does not occupy space?

- 1) leaf
- 2) noise
- 3) paper
- 4) feather

()

4. Danny classified the objects below into two groups.

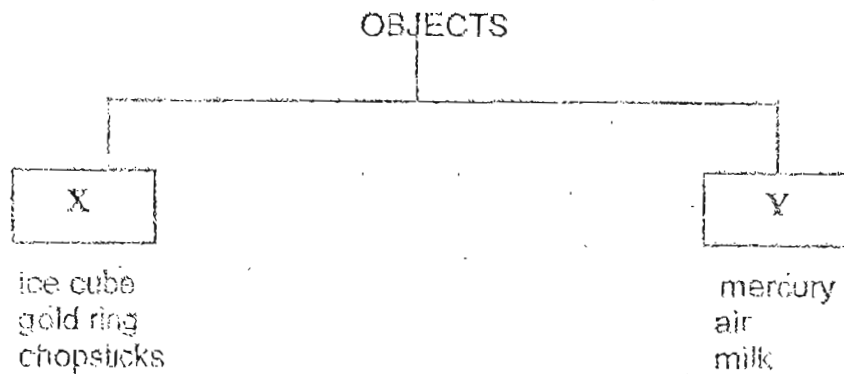

However, he has forgotten to put the headings for X and Y in his chart. What should the headings for X and Y be?

X	Y
1. Has definite volume	Has no definite volume
2. Has definite shape	Has no definite shape
3. Cannot be compressed	Can be compressed
4. Cannot dissolve in water	Can dissolve in water

- 5) In an experiment to study the effect of the amount of air needed to keep a candle burning, which one of the following variables must be changed?

- 1) The size of the candle.
- 2) The thickness of the jar.
- 3) The length of the wick.
- 4) The way burning time is measured.

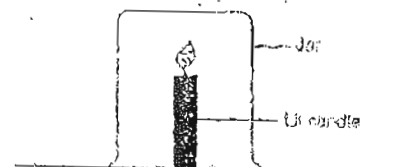

- 6) Which one of the following processes is correctly matched to the change of state that takes place in water?

PROCESS	CHANGE OF STATE
1. Freezing	Liquid to solid
2. Condensation	Solid to liquid
3. Evaporation	Liquid to solid
4. Melting	Liquid to gas

- 7) Jen put 15 pieces of ice cubes into a bowl and weighed them on a kitchen scale. The reading was as follows:

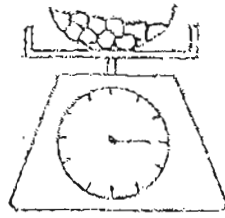

He then left the bowl of ice cubes on the table for 2 hours. When all the ice cubes had melted, he wiped the outside of the bowl and weighed again. Which one of the following diagrams shows the correct reading on the kitchen scale?

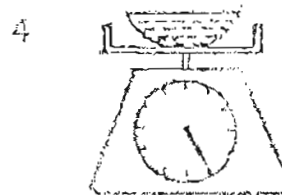
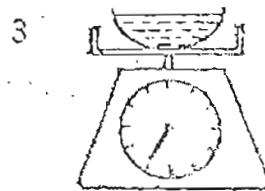
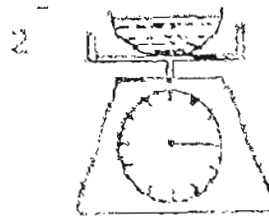
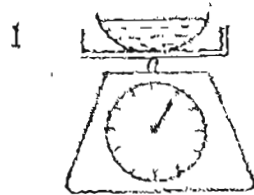

- 8) What causes the droplets of water to appear on the outside of the glass shown below?

It is caused by _____

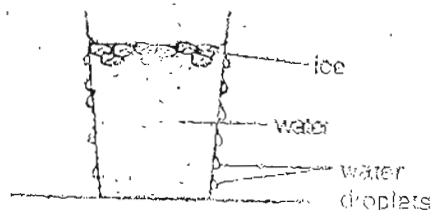

- 1) water leaking from the glass.
- 2) the melting of ice inside the glass.
- 3) condensation of water vapour from the surrounding air.
- 4) water in the glass losing heat to the surrounding air.

- 9) Which one of the following correctly describes what happens when all ice in a container is allowed to melt and then reach room temperature?

Mass	Volume	Temperature
1. Increases	Increases	Decreases
2. No change	Decreases	Increases
3. Decreases	Increases	No change
4. No change	Decreases	No change

- 10) Look at the diagrams below. Both containers contain the same amount of water.

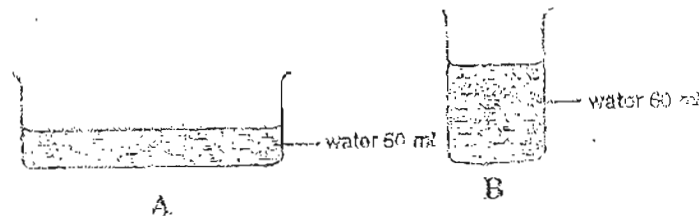

It is observed that the water in both containers dry up at about the same time. Which one of the following is the likely explanation for the observation made?

- 1) The water in Container A is hotter than that in Container B
 - 2) The water in Container B is hotter than that in Container A.
 - 3) Container B is put in a cool and shady place while Container A is put in a warm place.
 - 4) The exposed surface area of water in Container A is larger than that of Container B.
- 11) In the experiment shown below, what will happen to the water in the test tube if the test tube is placed into a beaker of ice?

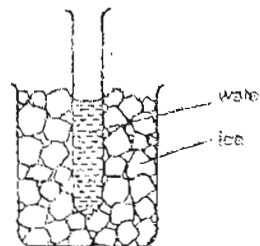

- 1) It will become ice.
- 2) Its temperature will drop.
- 3) Its temperature will rise.
- 4) Its temperature will rise and then drop.

- 12) Beakers A and B contain an equal amount of ice. They are heated using two heaters set at different temperatures as shown below. Which one of the following graphs correctly shows the changes in temperatures?

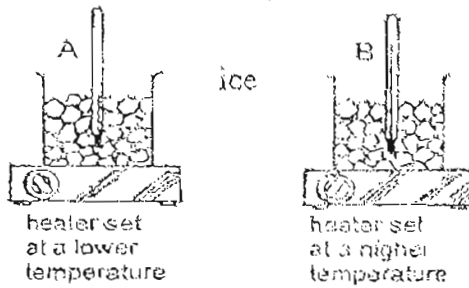

(1)

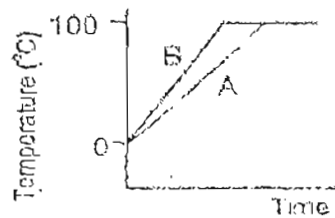

(2)

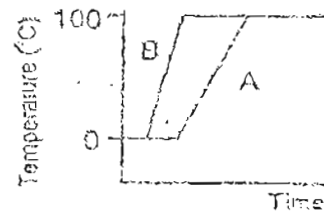

(3)

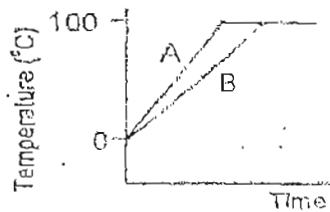

(4)

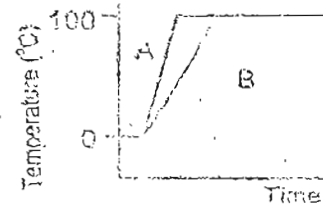

()

- 13) A match box containing an unknown object is placed on the 10th sheet of glass in the experimental set-up shown below.

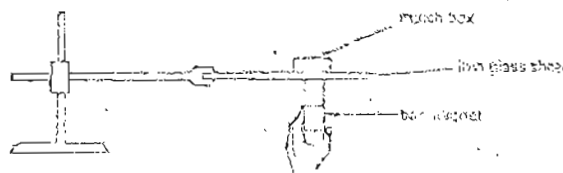

When a bar magnet placed below the piece of glass, it is able to drag the match box. What is most likely to be found in the match box?

- 1) gold rings
- 2) marbles
- 3) plastic paper clips
- 4) steel ball bearings

()

- 14) A steel wire can be made into a magnet by using the stroking method as shown in the diagram below. The arrows in each diagram indicate the direction of movement of the magnet. Which diagram correctly indicates the positions of the North and South poles of the steel wire?

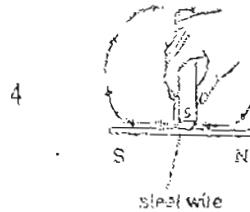
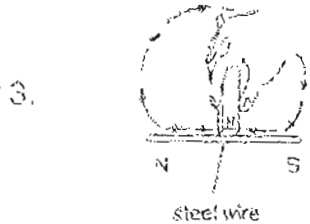
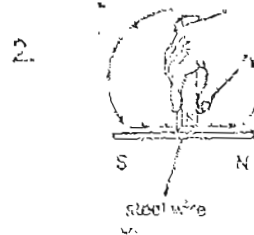
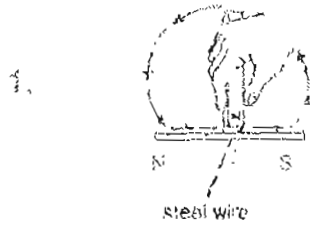

- 15) Which one of the following iron nails will not become a magnet?

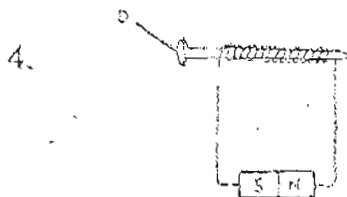
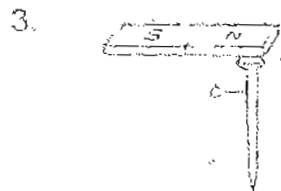

16. Three ring magnets are placed together by putting a pencil through the centre of the magnets.

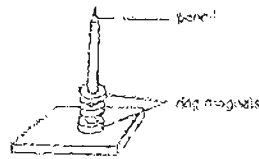

The ring magnets "float" one on top of another because of the _____

- 1) repulsion between the magnets
- 2) attraction between the magnets
- 3) repulsion between the magnets and the pencil
- 4) attraction between the magnets and the pencil

()

17. Which of the following can cause a magnet to lose its strength?

- A : Storing the magnet in oil for a few days.
- B : Heating the magnet over a strong flame.
- C : Hitting the magnet with a hammer several times.
- D : Dropping the magnet on the floor several times.

- 1) A and B only
- 2) C and D only
- 3) A, B and C only
- 4) B, C and D only

()

18. James was given four experimental set-ups as shown below.

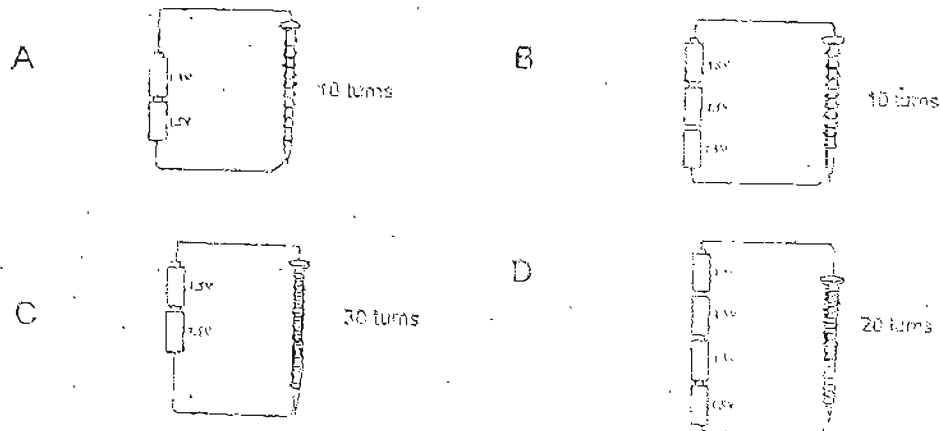

He was asked to find out whether the strength of an electromagnet is dependent on the number of turns of wire wound round the nail. Which pair of set-ups should he use for the comparison?

- 1) A and B
- 2) A and C
- 3) B and C
- 4) C and D

()

19. Which statements are true about heat?

- A : Heat can melt matter.
- B : Heat can cause matter to contract.
- C : Heat can flow from a hotter object to a colder object.
- D : Heat can flow from a colder object to a hotter object.

- 1) A and B only
- 2) C and D only
- 3) A and C only
- 4) B and D only

20. Which one of the following appliances produces heat but not light when it is turned on?

1.



gas stove

2.



reading lamp

3.



kerosene lamp

4.



hot plate

21. A group of students filled a test tube with red-coloured water and closed it as shown in the diagram. They then placed the test tube into a basin of ice cubes and watched the water level in the glass tube very carefully.

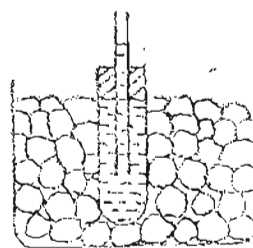

They noticed that the level of water rose slightly before it dropped.
They deduced that _____

- 1) the test tube expanded first and then contracted.
- 2) the coloured water expanded first and then contracted.
- 3) there were not enough ice cubes to cool the water quickly.
- 4) the test tube contracted first before the water got cooled.

22. Mother uses a pair of kitchen gloves to lift pots and pans when she is cooking.

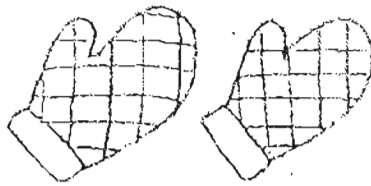

She needs them because they.....

- 1) keep her hands clean.
- 2) do not burn easily.
- 3) are good conductors of heat.
- 4) are good insulators of heat.

23.

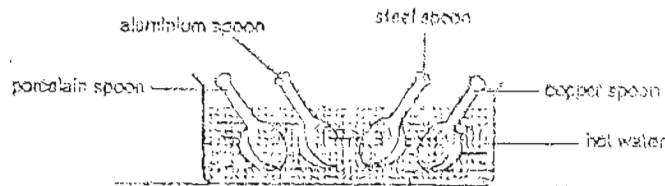

Four spoons are placed in a container of very hot water. Which spoon could you pick up with your bare hands?

- 1) Copper spoon
 - 2) Steel spoon
 - 3) Porcelain spoon
 - 4) Aluminium spoon
24. Vivien wanted to find out whether a cube of sugar dissolves faster in hot water or cold water. Which one of the variables must be changed to make her investigation a fair one?
- 1) The amount of sugar used.
 - 2) The amount of water used.
 - 3) The kind of container used.
 - 4) The temperature of water.

25 Study the graph below carefully.

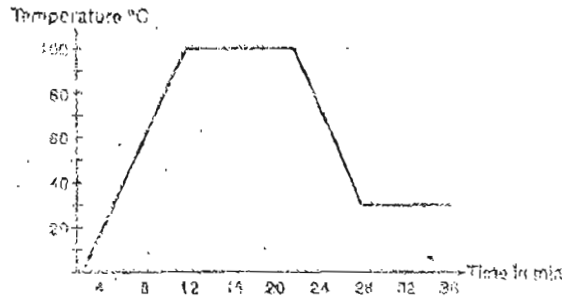

A beaker of ice cubes was heated for some time and was left to cool. The temperature was taken at intervals of two minutes. How long did the water take to reach room temperature?

- 1) 4 minutes
- 2) 8 minutes
- 3) 12 minutes
- 4) 28 minutes

()

26. Which one of the following will lose the most heat?

- 1) glass
- 2) ice cubes
- 3) metal spoon
- 4) warm water

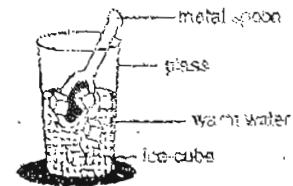

()

27. Beaker A contains 500 ml of water and Beaker B contains 200 ml of water were heated continuously even after the water boiled. Which of the statements about them are correct?

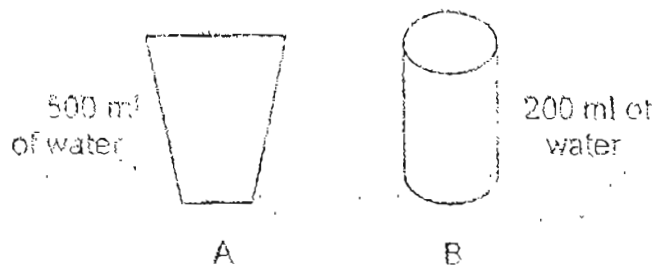

- A : Temperature of water in both beakers is the same.
- B : Beaker A produces more water vapour than Beaker B.
- C : Temperature of water in Beaker B is higher than that of Beaker A.

- 1) A only
- 2) B only
- 3) B and C only
- 4) A and B only

()

28. The metal strip shown below is made up of two different metals, X and Y, bound together. X expands faster than Y when heated.

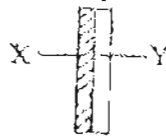

How would the strip look like when it is heated strongly over a Bunsen burner?

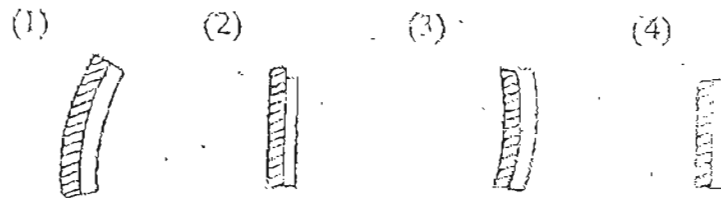

29. Study the three set-ups shown below. Which of them can be used to demonstrate that water expands when heated?

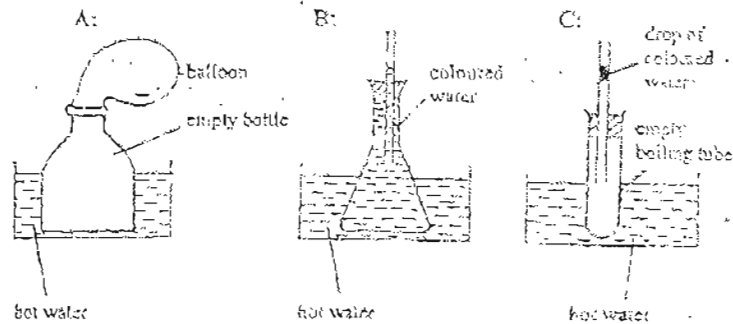

- 1) A only
- 2) B only
- 3) A and B only
- 4) B and C only

30.

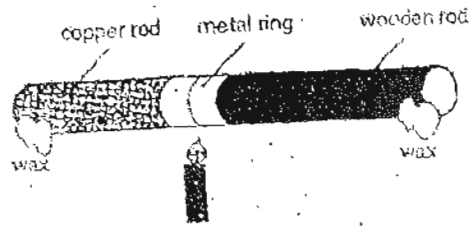

A copper rod and a wooden rod were held firmly together by a metal ring. The rods were heated at the metal ring. After a short while, the wax on the copper rod melted but not the wax on the wooden rod. Which of the following is true about the experiment?

- A : Heat travels through metal readily.
- B : Heat does not travel through wood easily.
- C : Heat travels from the hotter end of the object to the cooler end of the object.
- D : Heat travels from the cooler end of the object to the hotter end of the object.

- 1) A and C only
- 2) B and D only
- 3) A, B and C only
- 4) B, C and D only

()

SECTION B (20 MARKS)

Read the questions carefully and write the answers in the blanks provided.

31. Several items were thrown into a glass bowl of water.



a) What should John do in order to remove the items without touching the water? (1m)

b) What does this experiment show? (1m)

32. Jane wants to test if the pull of the magnet can pass through the following materials. She places a paper clip on each material:

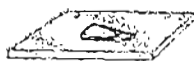

glass



wood



paper

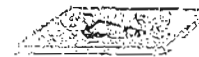

plastic

a) Do you think the test is a fair one? Why? (1m)

b) State 1 variable that she must keep the same other than the one stated above for the test to be fair? (1m)

33. 30 ml of water is poured into each of the containers A, B, C and D.

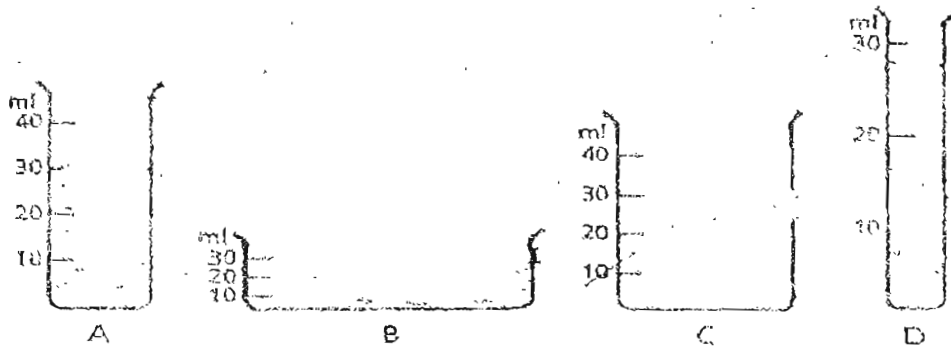

- Draw the water level for each of the container. (1m)
- State 1 property of water indicated in this experiment. (1m)

34. 500 ml of air is pumped into each of the 4 balls of different sizes as shown in the table below.

BALL	VOLUME
A	350 ml
B	400 ml
C	500 ml
D	600 ml

- Which of these balls can hold all the 500 ml of air? (1m)
- Give a reason for your answer. (1m)

35. Look at the diagram of the water cycle below.

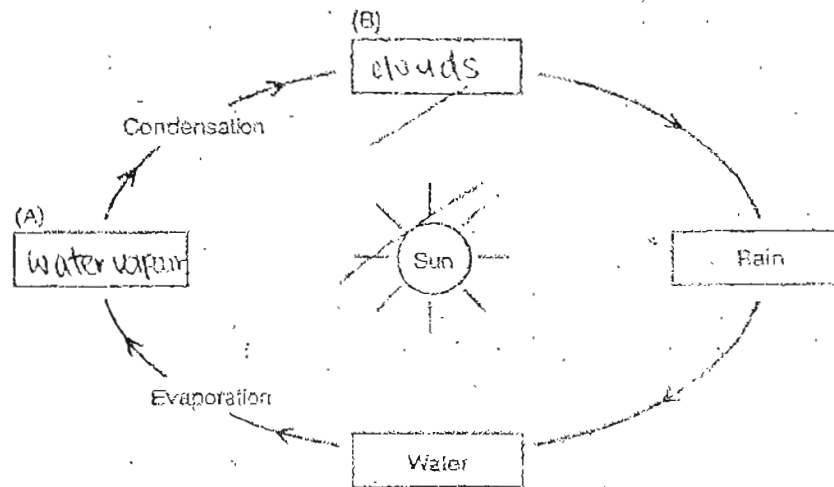

- a) Fill in boxes A and B above. (1m)
- b) Why is the water cycle important to Man? (1m)

36. A glass of water at room temperature was left in the freezer. The graph shows the changes in the temperature of the water.

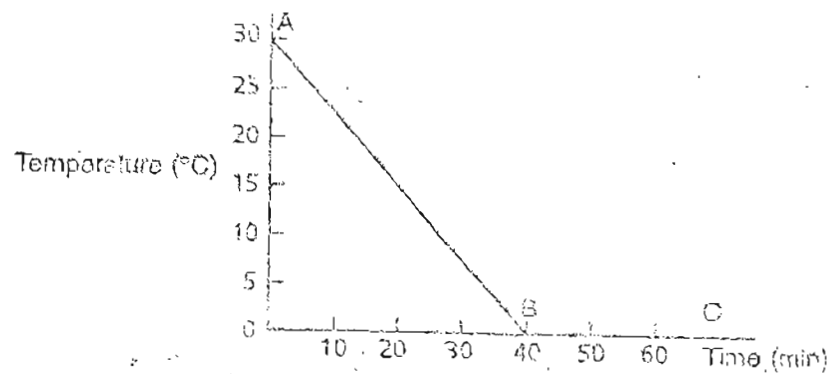

- a) In what state was the water at C? (1m)
- b) Name the process that took place from B to C? (1m)
- c) How long did the water take to reach 0°C ? (1m)

37.

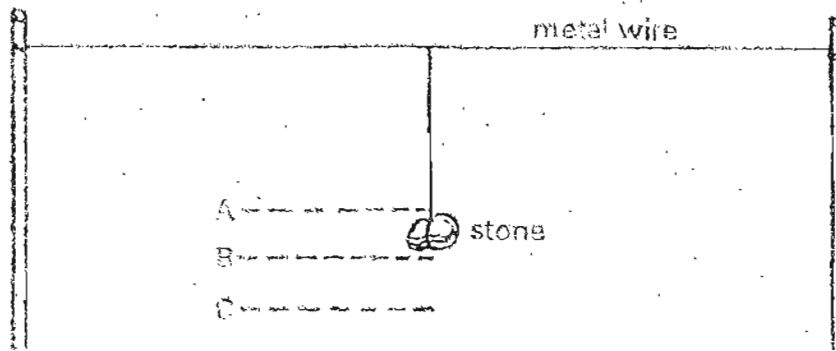

A piece of stone was hung on a metal wire in the garden.

a) On a hot day, the position of the stone would most like be at

_____ (1m)

b) This is because the metal wire _____ on a hot day.

(1m)

38.

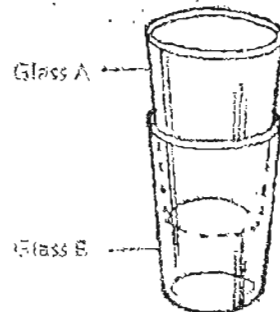

Two glasses are stuck together. No matter how hard Ken tried, he cannot separate them.

How would you separate them? (2m)

39. For each of the following examples, identify the object that is losing heat and the object that is gaining heat. (3m)

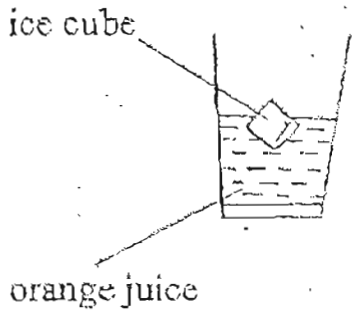
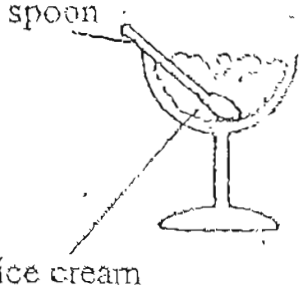
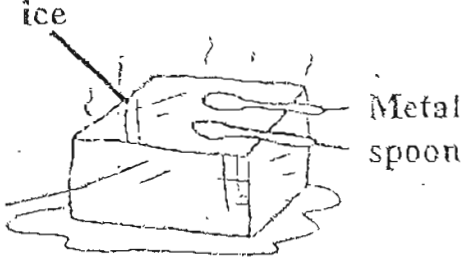
Example	Object that is losing heat	Object that is gaining heat
 <p>ice cube</p> <p>orange juice</p>		
 <p>spoon</p> <p>ice cream</p>		
 <p>ice</p> <p>Metal spoon</p>		

HAVE YOU CHECKED YOUR WORK?

METHODIST GIRLS SCHOOL (PRIMARY)
 CONTINUAL ASSESSMENT 2, 2004
 PRIMARY 4 SCIENCE

Handwritten scribbles

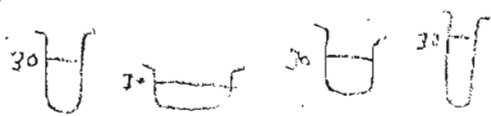
- 1) 2 27) 4 31) a) He should place a magnet outside
 the bowl of water and drag it up
 slowly.
- 2) 3 28) 1
- 3) 2 29) 2 b) Magnetism can pass through the
 glass and water.
- 4) 2 30) 3
- 5) 2 32) a) No. The thickness of the material
 must be the same.
- 6) 1 b) He must use the same magnet for
 the paperclips in the experiment.
- 7) 2
- 8) 3 33) a) 
- 9) 2
- 10) 2 b) Liquid does not have definite shape.
- 11) 2 34) a) A, B, C and D b) Air can be compressed.
- 12) 2 35) a) (A) water vapour (B) clouds
- 13) 4 b) It ensures a continuous supply of fresh
 water for people. Without it, we would not
 have any fresh water to drink.
- 14) 1
- 15) 4 36) a) Solid b) Freezing c) 40 minutes
- 16) 1 37) a) C
- 17) 4
- 18) 2 b) expands
- 19) 3 38) I would pour hot water on the bottom glass B.
 to make it expand.
- 20) 4 39) Orange juice ice cube
- 21) 4 Spoon ice cream
- 22) 4 Metal spoon ice
-
- 23) 3
- 24) 4
- 25) 4
- 26) 4