



RAFFLES GIRLS' PRIMARY SCHOOL

SEMESTRAL ASSESSMENT 2

2008

Name: _____ Index No: _____ Class: P4 _____

29 October 2008 SCIENCE Att: 1 hr 30 min

Section A	/50	
Section B	/40	
Your score out of 90 marks		
Highest score	Class	Level
Average score		
Parent's signature		

SECTION A (25 x 2 marks)

For each question from 1 to 25, four options are given. One of them is the correct answer. Make your choice (1, 2, 3 or 4). Shade the correct oval (1, 2, 3 or 4) on the Optical Answer Sheet (OAS) provided.

1. June did a study on two animals, X and Y. She drew a checklist and placed a tick (✓) in the box when she made the observation.
At the end of her study, the completed checklist is as follows:

Observation	Animal X	Animal Y
Eggs are laid in water.	✓	
There are 4 stages in its life cycle.	✓	✓
It has six legs.	✓	✓

Which one of the following identifies X and Y correctly?

	Animal X	Animal Y
(1)	butterfly	cockroach
(2)	mosquito	butterfly
(3)	mosquito	cockroach
(4)	butterfly	beetle

2. The pictures below show the nymph and adult grasshopper.

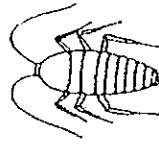

nymph

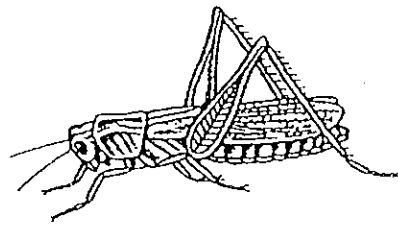

grasshopper

Based on your observation, which of the following statements is/are true about the nymph and adult grasshopper?

- A Both have 6 legs.
- B Both have feelers.
- C Both are **without** wings.

- (1) C only
- (2) A and B only
- (3) B and C only
- (4) A, B and C

3. The diagrams below show the different stages of growth of a plant.

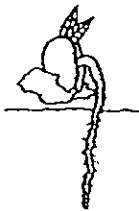

A



B

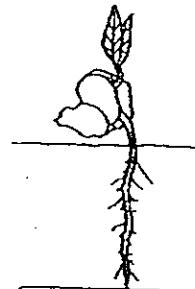

C



D

Which one of the following shows the correct order in which the young plant grows?

- (1) A → B → C → D
- (2) A → C → B → D
- (3) B → D → A → C
- (4) C → A → D → B

4. Figure 1 shows a leaf with two different coloured areas on a plant used in a photosynthesis experiment. The white area on the leaf has no chlorophyll.

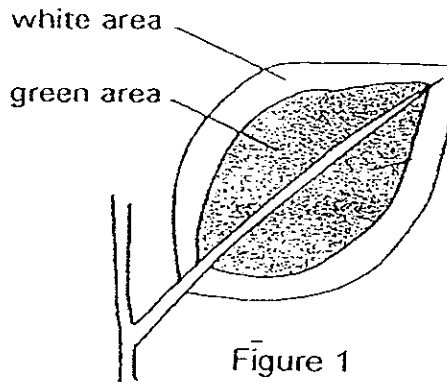

Figure 1

Next, the leaf was partly covered by black paper, as shown in Figure 2.

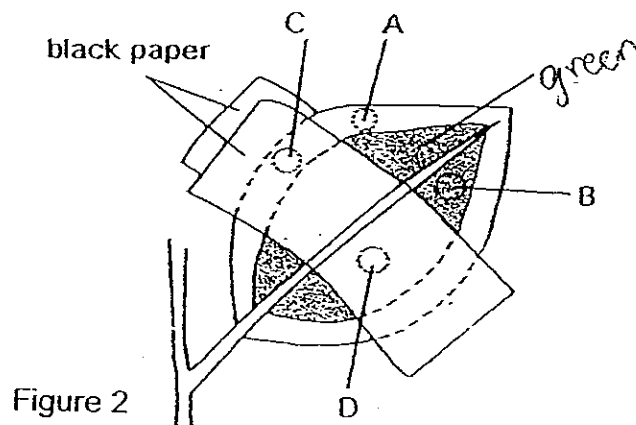

Figure 2

The plant was then put in the sun. After 2 days, the leaf was plucked off and the black paper was removed. The leaf was tested for starch.

Which of these areas, A, B, C and / or D, was / were starch mostly found?

- (1) A only
- (2) B only
- (3) A and B only
- (4) C and D only

5. The diagram below shows two green plants, X and Y, growing in a garden.

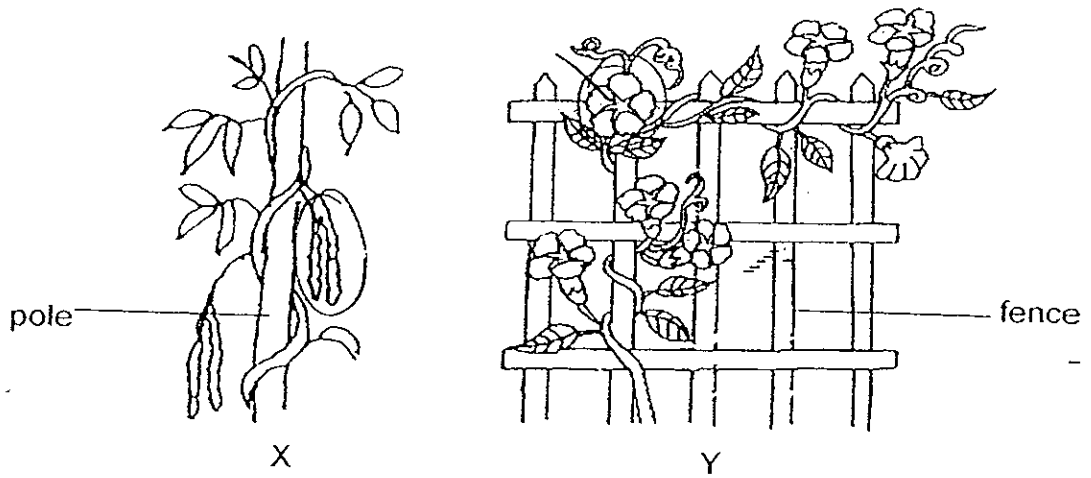

Which one of the following statements about both plants, X and Y, is **NOT** correct?

- (1) Both have weak stems.
- (2) Both make their own food.
- (3) Both reproduce by spores.
- (4) Both need a support to grow.

6. Mary ate a piece of bread for breakfast. The diagram below shows where the food was found at different times of the day.

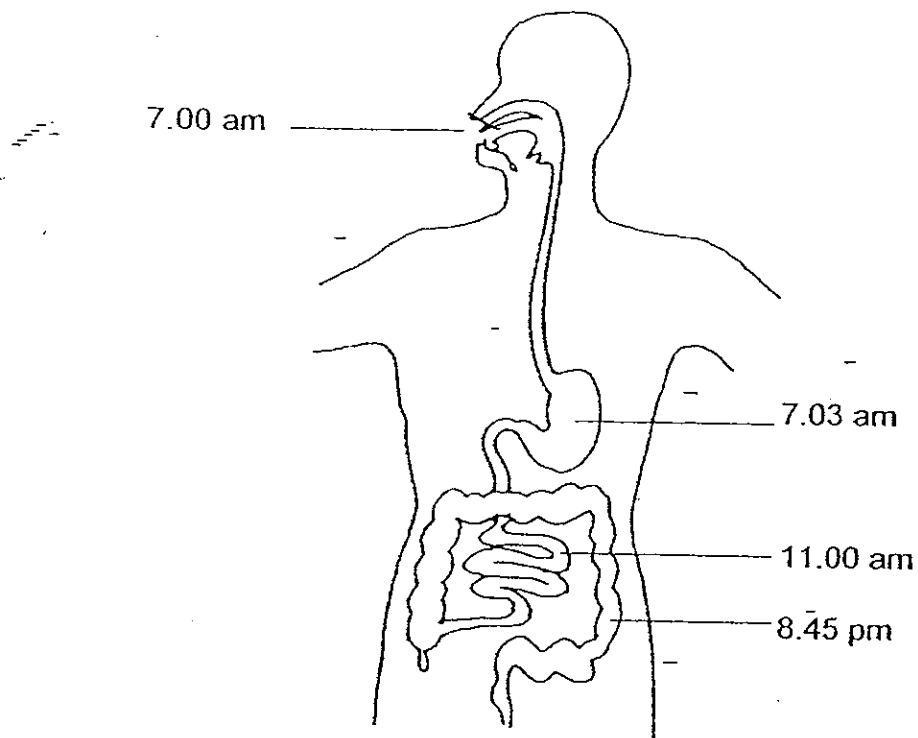

At about what time did the digestion of food begin?

- (1) 7.00 am
- (2) 7.03 am
- (3) 11.00 am
- (4) 8.45 pm

7. The diagram below shows part of the skeletal system of the human arm.

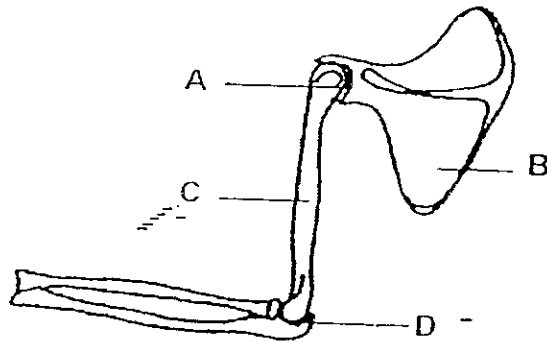

Which of these parts are the joints in the arm shown above?

- (1) A and B only
- (2) A and D only
- (3) C and D only
- (4) A, B, C and D

8. John observed two plants, Y and Z, using a table as shown below.

A tick (√) shows that the plant had the characteristic.

Characteristic \	Y	Z
bears fruit		√
grows on land	√	

From the information above, how could John classify the plants Y and Z using the classification chart below?

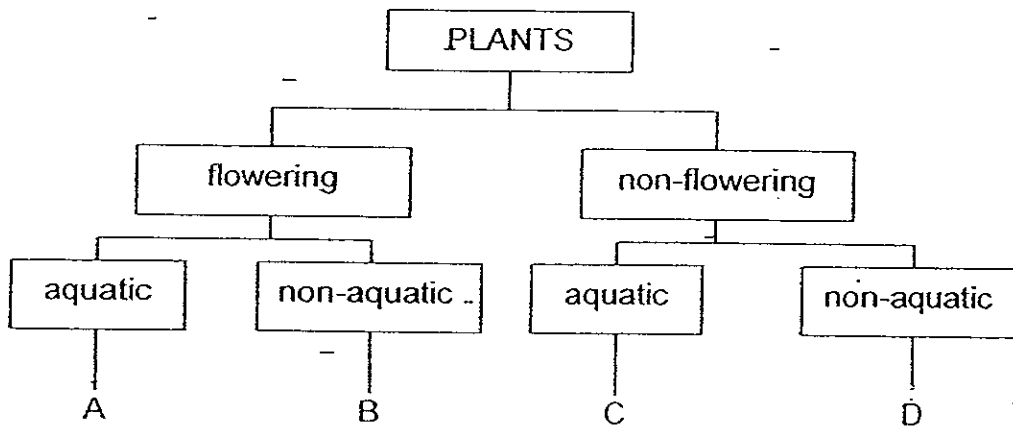

	Plant Y	Plant Z
(1)	A	D
(2)	B	C
(3)	C	B
(4)	D	A

9. Kim was given 5 leaves and she classified four of them as shown below.

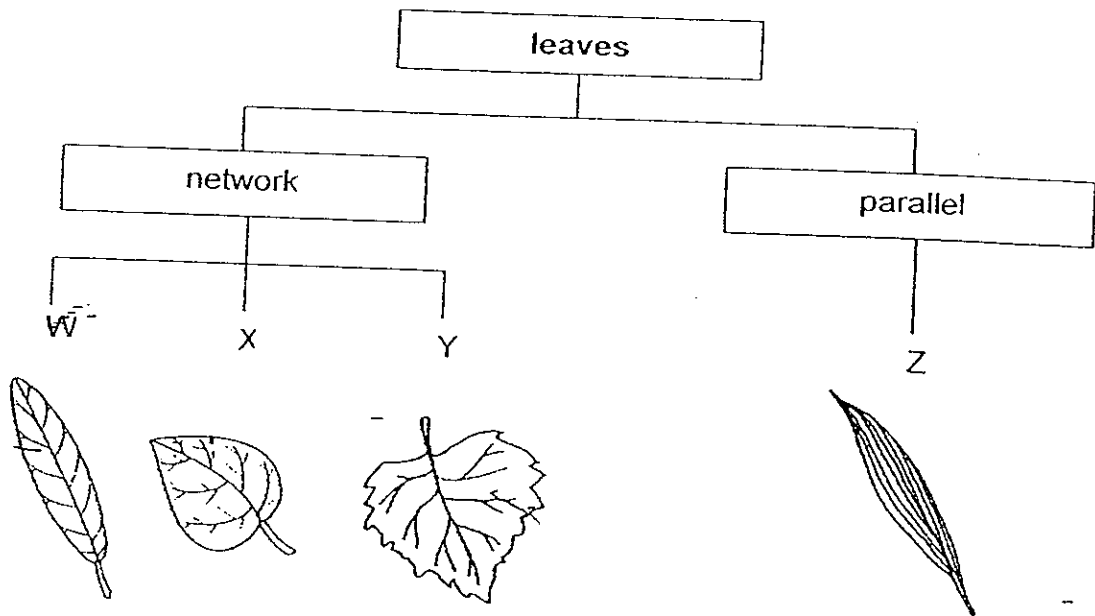

She was left with the last leaf as shown below

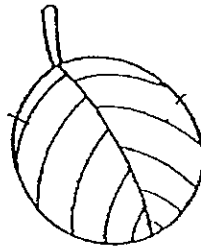

Based on the classification chart above, which group should Kim place this leaf?

- (1) W
- (2) X
- (3) Y
- (4) Z

10. James did a test to find out if the amount of water will affect the growth of the green bean plant.

He conducted the experiment using 5 pots of similar plants and measured their heights on the tenth day as shown below.

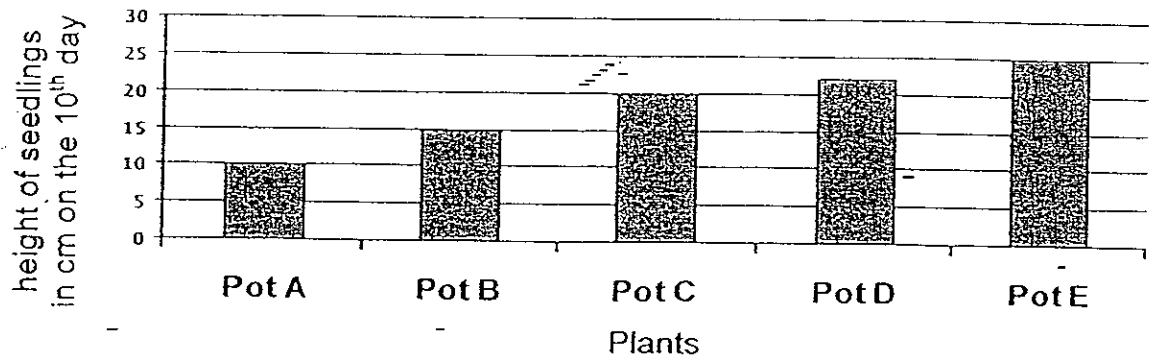

Which of the following conditions must James take note to ensure a fair test?

- A The type of soil
 - B The type of water
 - C The amount of water
 - D The size of the container
-
- (1) A and B only
 - (2) B and D only
 - (3) A, B and D only
 - (4) A, C and D only

11. Set-up 1 below shows the image of the letter 'C' when it was placed in front of a mirror.

Set-up 1

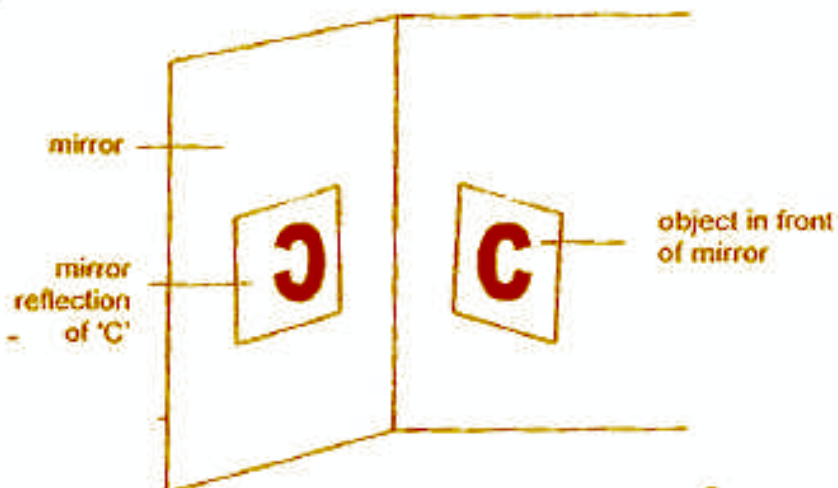

Set-up 2 below shows the object in front of the mirror.

Set-up 2

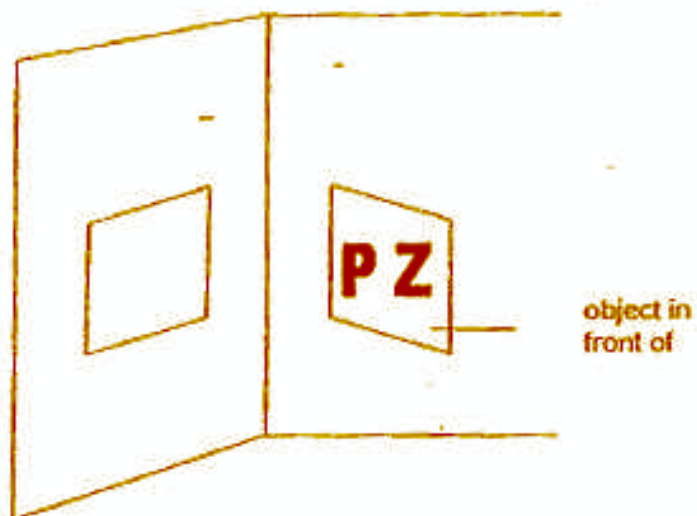

Which one of the following shows the mirror reflection in Set-up 2?

(1) **PZ**

(2) **ΣP**

(3) **Σq**

(4) **qZ**

- 12 The diagram below shows three pieces of objects. Objects A and C are made of wood, while object B is made of clear glass.

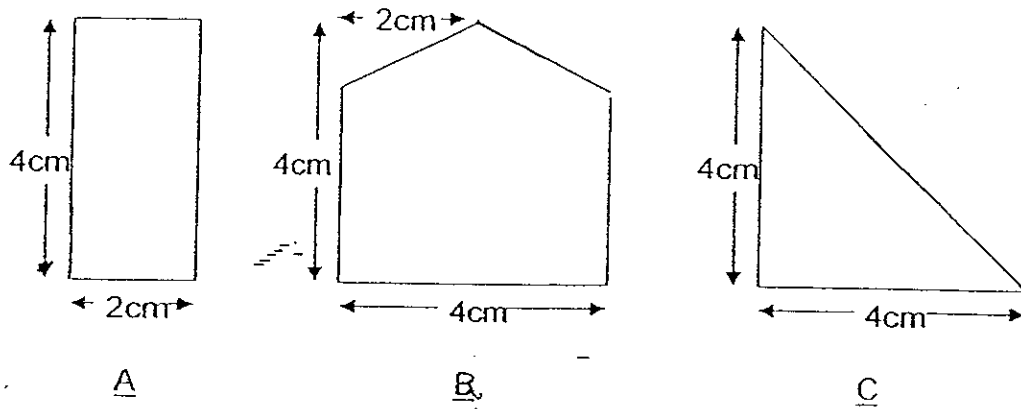

The three pieces of objects are glued together. They are then placed between a torch and a screen as shown below.

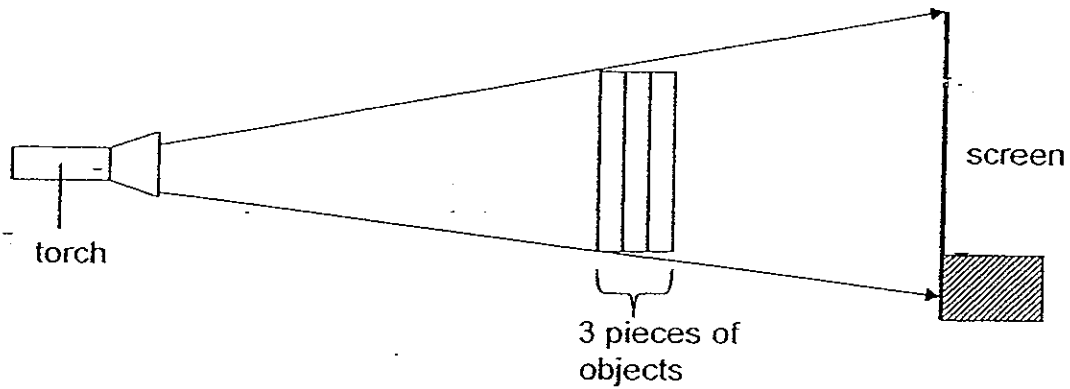

Which one of the following shadows is formed on the screen?

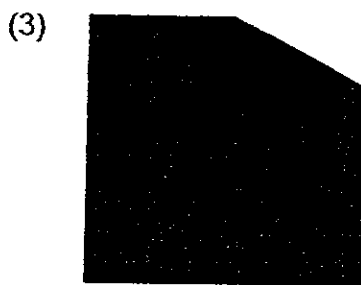
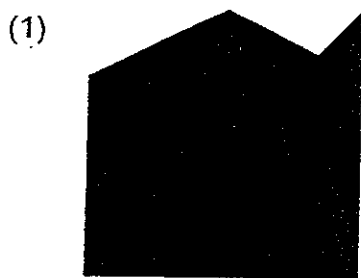

13. The diagram below shows the shadow cast by a 'STOP' sign.

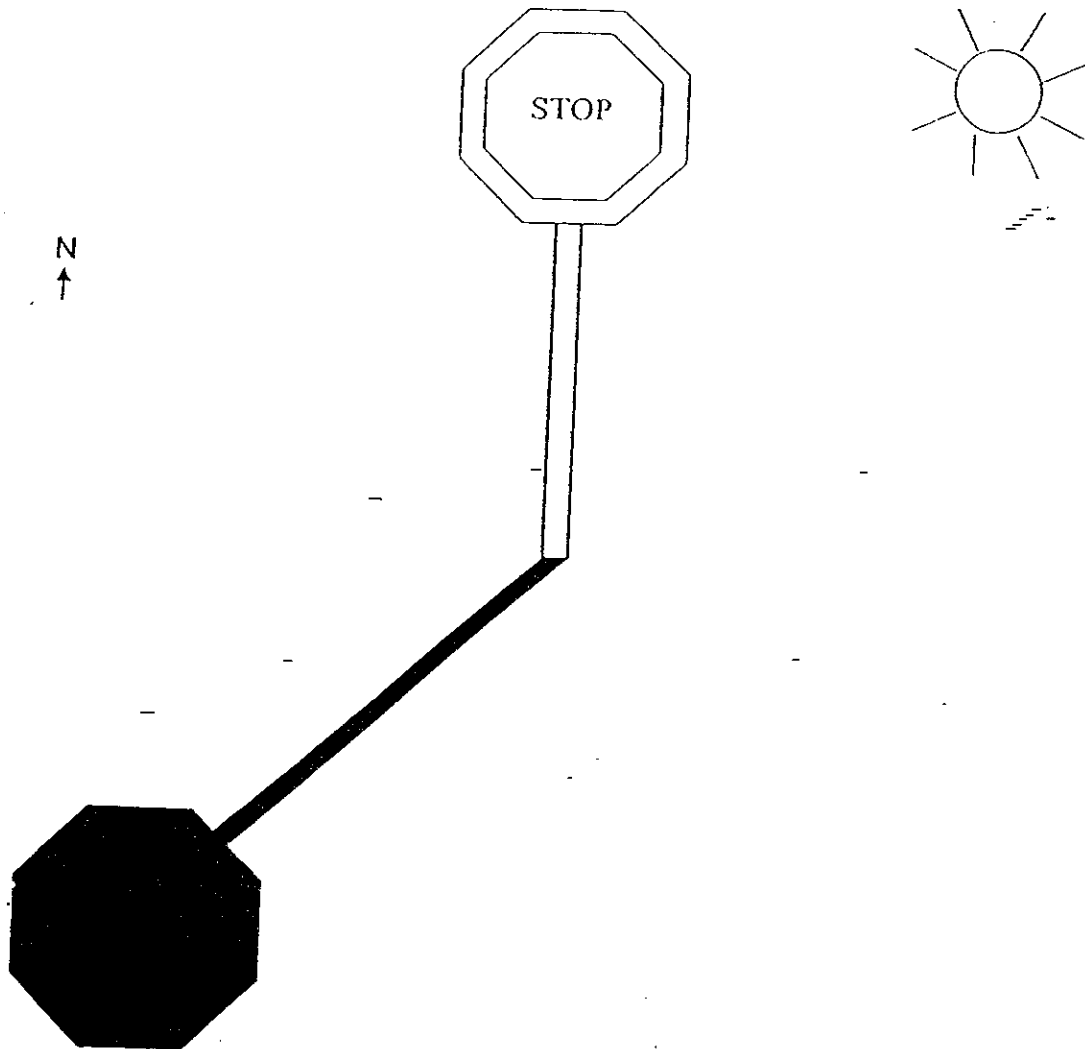

The shadow is most likely formed at _____.

- (1) 8 a.m.
- (2) 12 p.m.
- (3) 3 p.m.
- (4) 6 p.m.

14. Nicole heated 4 materials, A, B, C and D. The graph below shows the rise in their temperatures during heating after 10 minutes.

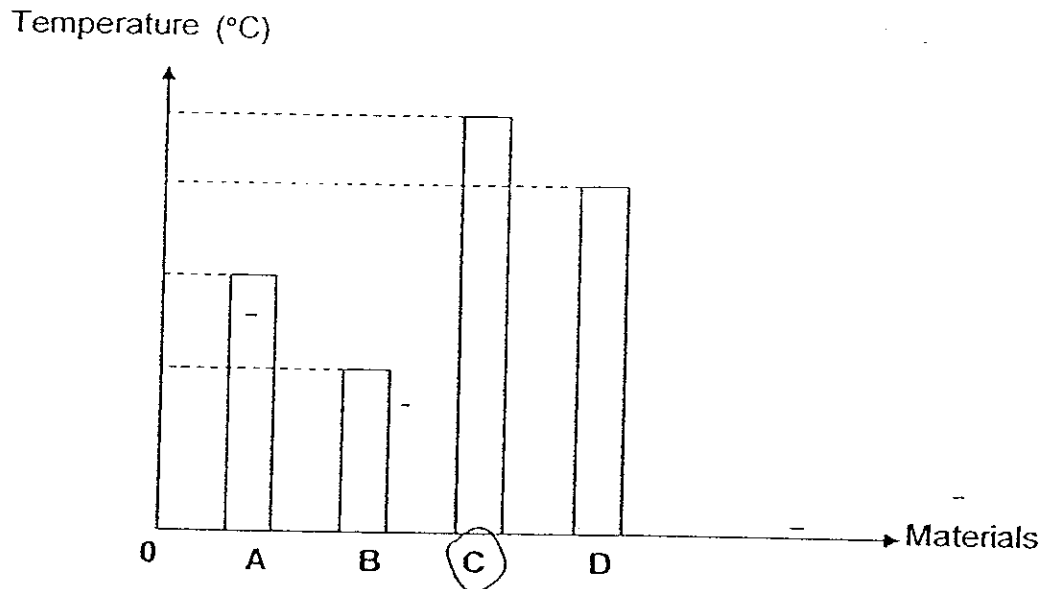

Based on the graph above, which material, A, B, C or D, is the most suitable material to be made into part R of the frying pan?

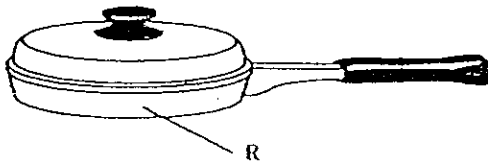

- (1) A
- (2) B
- (3) C
- (4) D

15. Fiona filled three basins with warm water, tap water and ice water as shown in the diagram below.

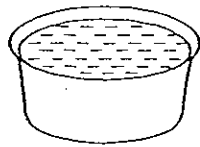

warm water

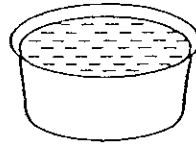

tap water

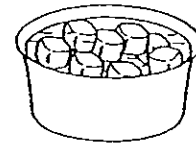

ice water

She put her right hand in warm water and her left hand in ice water.

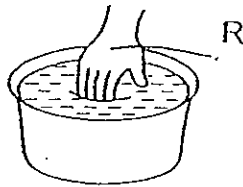

warm water

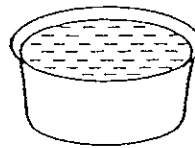

tap water

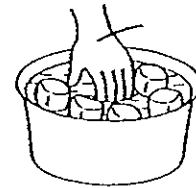

ice water

After three minutes, she put both her hands in the basin of tap water.

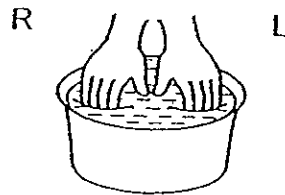

tap water

Which one of the following shows correctly how her hands would feel?

	left hand	right hand
(1)	warm	warm
(2)	warm	cold
(3)	cold	cold
(4)	cold	warm

16. Ali attached 4 thumbtacks using wax to an iron rod as shown in the diagram below. He then heated the rod at point X.

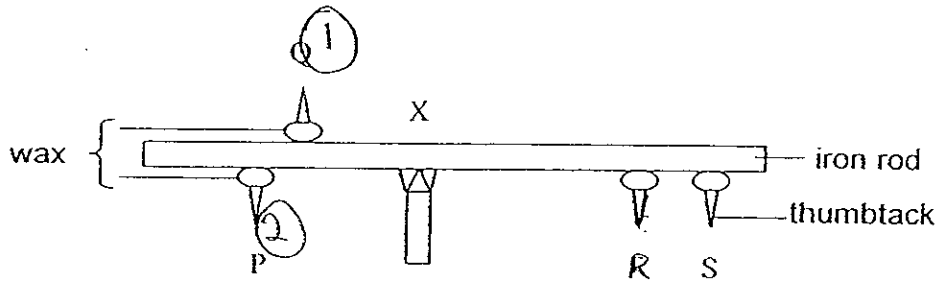

Which one of the following will show the order in which the thumbtacks fell?-

- (1) P, Q, R, S
- (2) P, R, S, Q
- (3) Q, P, R, S
- (4) Q, R, P, S

17. Sarah wanted to find out whether pond water or tap water would boil faster. The diagrams below show five possible set-ups, A, B, C, D and E.

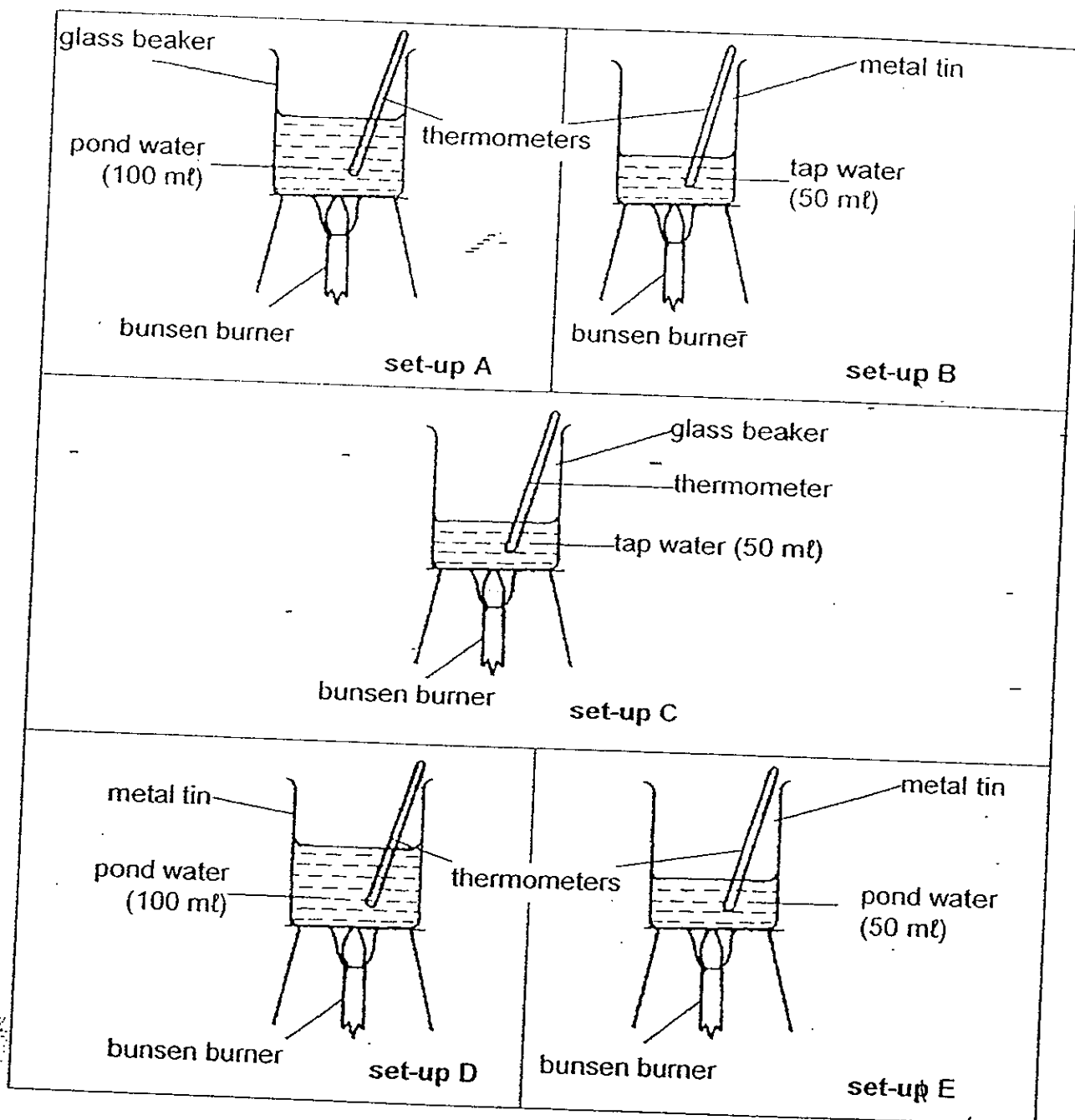

Which two set-ups should Sarah compare so that she can make a conclusion?

- (1) A and B
- (2) A and C
- (3) B and E
- (4) D and E

18. Steven has 4 objects A, B, C and D.
 When he puts A into a measuring cylinder containing 10 cm³ of water, the water level rises. He puts in B, C and D, one at a time and plots the graph below to show the changes in the water level in the measuring cylinder.

Height of water level (cm)

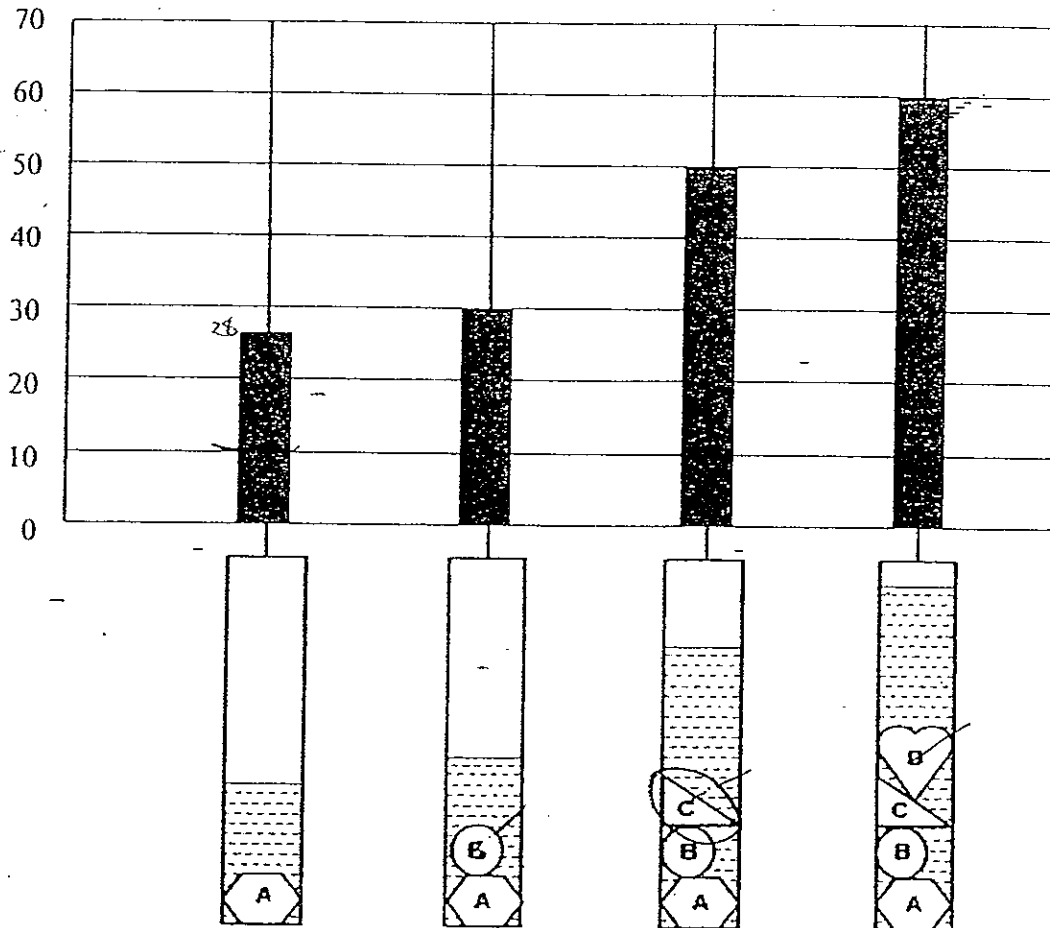

Which of the 4 objects, A, B, C or D, has the largest volume?

- (1) A
- (2) B
- (3) C
- (4) D

19. The diagram below shows the properties of various matter at room temperature.

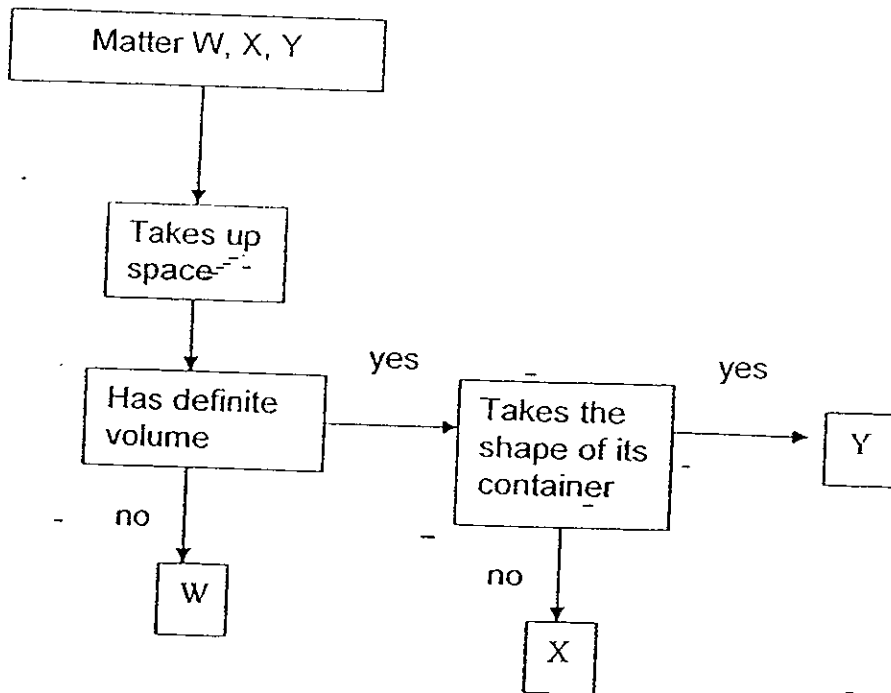

Which one of the following represents correctly the matter W, X and Y?

	W	X	Y
(1)	oxygen	juice	sand
(2)	water	stone	nitrogen
(3)	air	wood	milk
(4)	carbon dioxide	ice cube water	flour

20. Wendy placed a toy car made of steel on an aluminium sheet. She held a strong magnet under it as shown in Diagram 1 below.

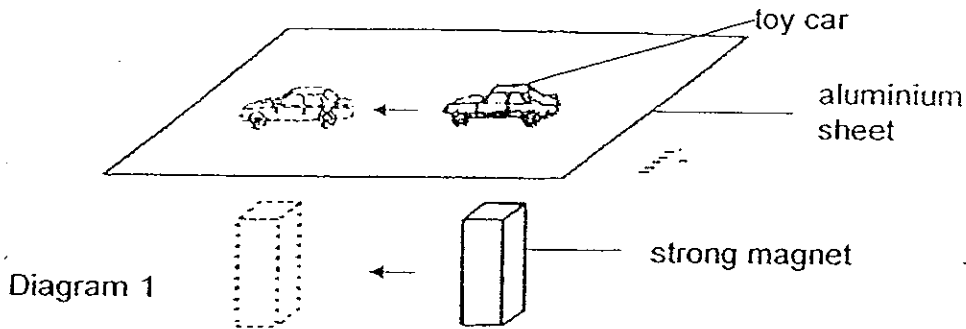

When she moved the magnet, she noticed that the toy car moved in the same direction.

When Wendy replaced the aluminium sheet with an iron sheet, she noticed that the toy car did not move when she moved the magnet as shown in Diagram 2 below.

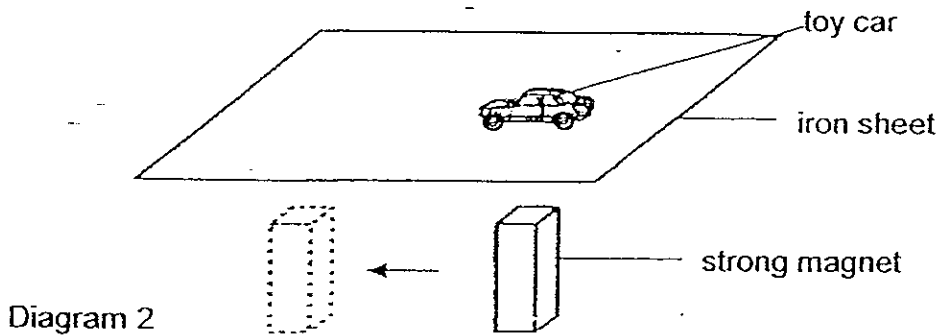

Which one of the following statements explains correctly her observations in Diagram 2?

- (1) The iron sheet repelled the magnet.
- (2) The toy car was attracted to the iron sheet.
- (3) The iron sheet was attracted to the magnet.
- (4) The toy car was attracted to the strong magnet.

21. Sandra put a bar magnet into a glass. She placed the glass over some iron filings. She observed that the iron filings were attracted to the bottom of the glass as shown in the diagram below.

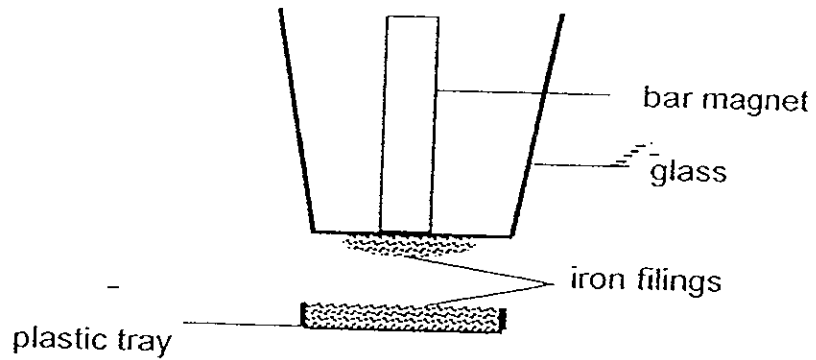

This experiment shows that _____

- (1) the iron filings were attracted to the glass
- (2) magnetic force could pass through the glass
- (3) the glass was magnetised by the bar magnet
- (4) the south pole of the bar magnet was attracted to the glass

22. The diagram below shows bar magnet A with 3 thumbtacks hanging from it.

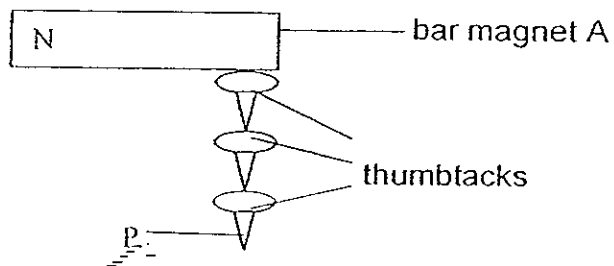

A bar magnet B is brought close to the end of thumbtack 'P' as shown below.

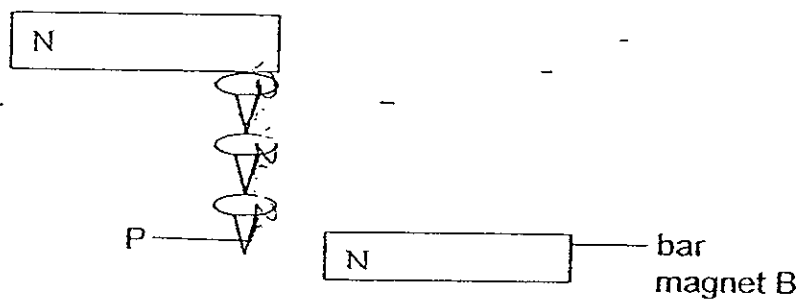

What will happen to thumbtack 'P'?

- (1) It will **not** move.
- (2) It will fall to the ground.
- (3) It will repel from bar magnet B.
- (4) It will be attracted to bar magnet B.

- 23 The diagram below shows four magnets, A, B, C and D, hanging from strings of different lengths. A glass tray of steel thumbtacks is placed below the magnets and different number of thumbtacks are attracted to each magnet.

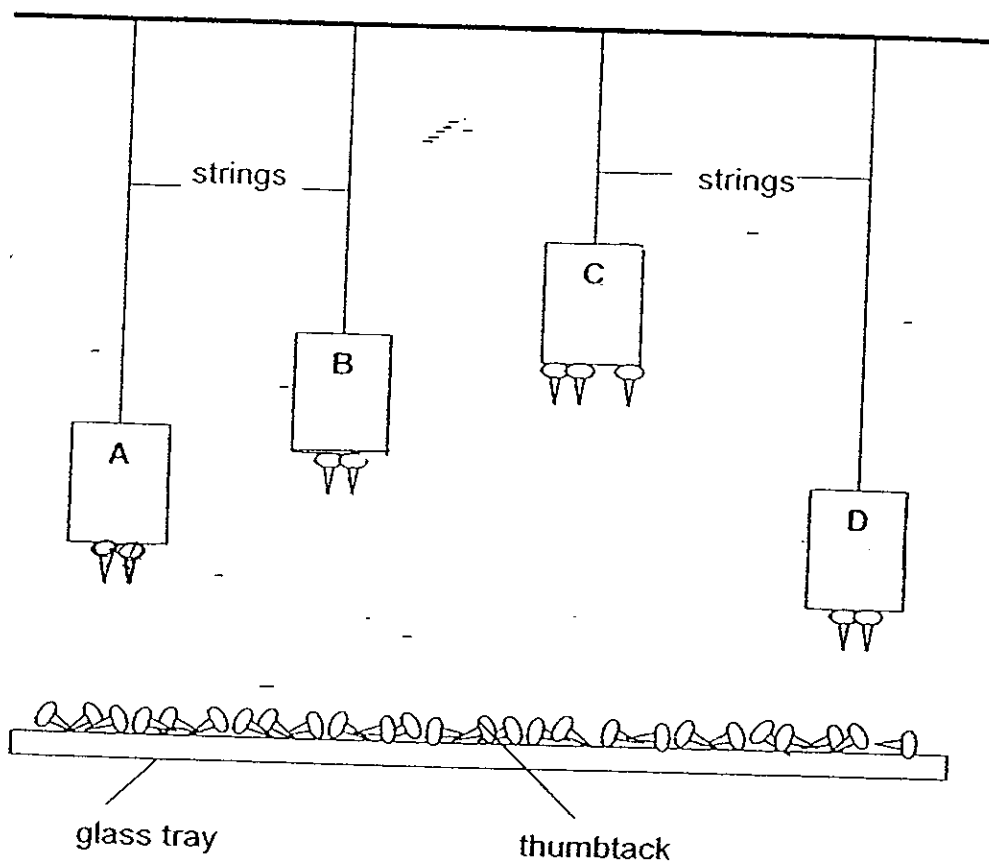

Which one of the following shows the correct order of the strength of the magnets from the weakest to the strongest?

	weakest → strongest			
(1)	C	A	B	D
(2)	C	B	A	D
(3)	D	B	A	C
(4)	D	A	B	C

25. The diagram below shows a bar magnet cut into 3 pieces, X, Y and Z.



Which one of the following arrangements will allow two of these pieces of the magnet to attract each other?

(1)

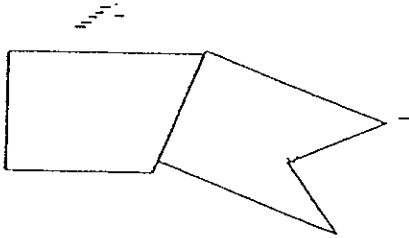

(2)

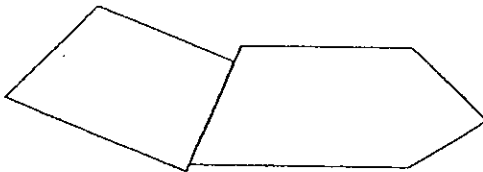

(3)

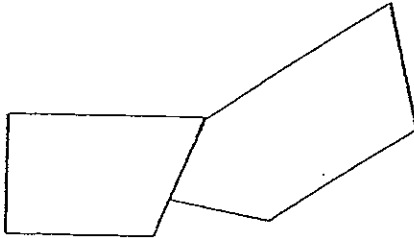

(4)

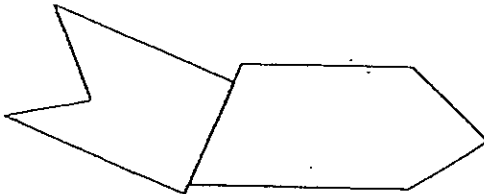

Name : _____

Index No: _____

Class: P4 _____

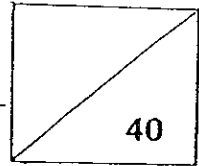

SECTION B (40 marks)

For questions 26 to 41, write your answers clearly in the spaces provided. The number of marks available is shown in brackets [] at the end of each question or part question.

26. Nadia studies the life cycle of a mosquito as shown in the diagram below.

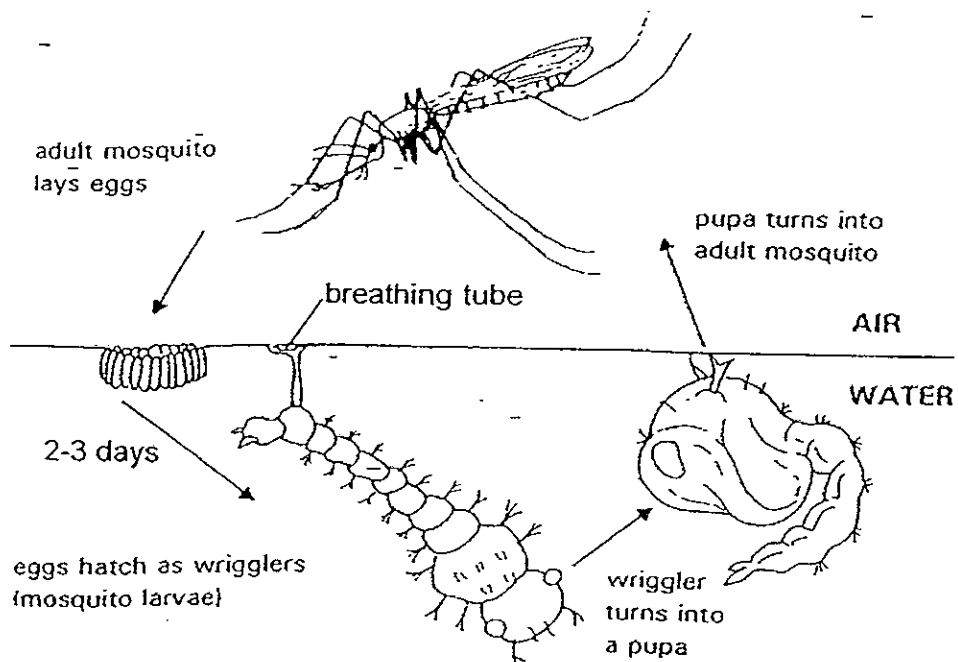

- (a) She said that one way of controlling the population of mosquitoes was to spread a layer of oil on the surface of the water.

Explain why this method can be used to control the population of mosquitoes.

[1]

- (b) Another way of preventing the mosquitoes from breeding is to remove the stagnant water.

Give a reason why Nadia should remove the stagnant water.

[1]

27. Ken conducted an experiment with 2 set-ups as shown below.

In Set-up A, seeds were placed in dry soil. The seeds in Set-up B were placed in wet soil. Both set-ups were then placed in his locker.

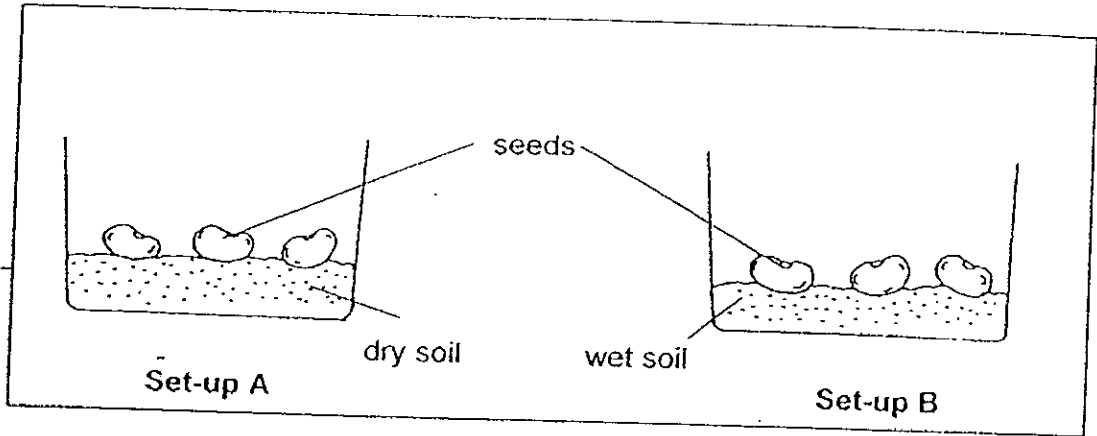

(a) Which seeds in the above set-ups germinated?
Give a reason for your answer.

[1]

(b) After a week, Ken noticed that the young seedlings with leaves mentioned in (a) were **NOT** growing well. Why?

[1]

28. Sue set up the experiment as shown below. She placed the beakers near the windows in the Science Lab.

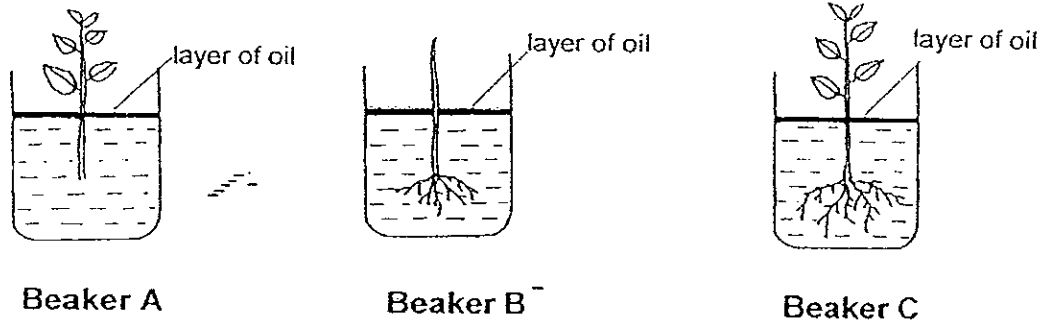

Which one of these beakers, A, B or C, showed the lowest water level after a week?

Give a reason for your answer.

[2]

Beaker _____

29. The diagram below shows the parts involved in the circulatory system of a mammal.

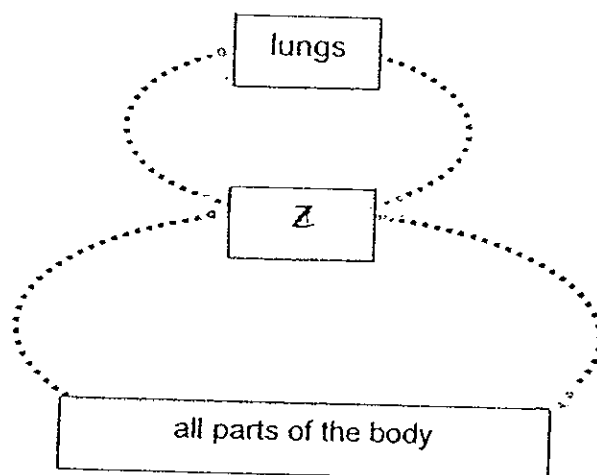

- (a) Complete the diagram above by drawing in the **ARROWHEADS** (**▶**) on the dotted line to show the directions in which blood flows from one part to another. [1]
- (b) Name organ Z [1]
- (c) What is the function of organ Z? [1]

30. Rachel made a model of the chest as shown below.
When Rachel pulled the rubber sheet downwards, the balloons inflated.

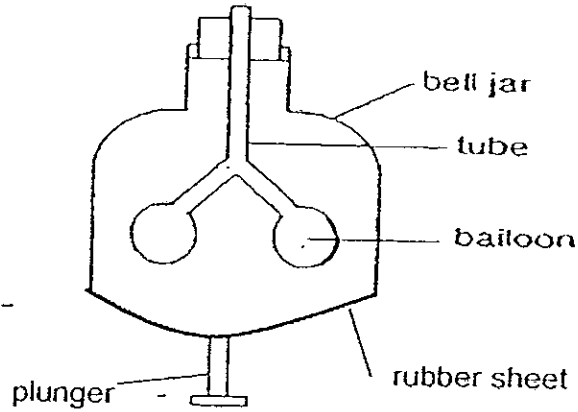

When Rachel let go of the rubber sheet, the balloons deflated.

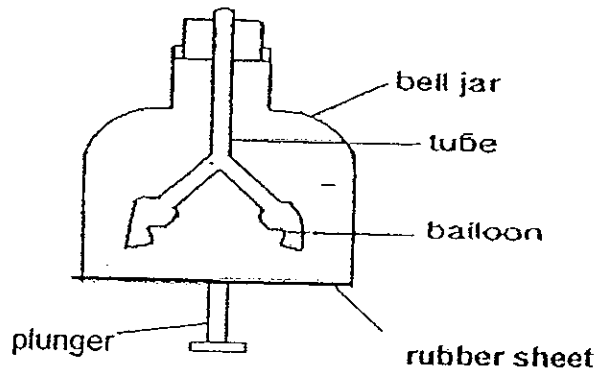

- (a) Fill in the blanks below with a suitable word(s) to explain why the model is **NOT** an accurate representation of how we breathe. [2]

Reason 1	The bell jar did not _____ like our chest did when we breathed in.
Reason 2	The rubber sheet should continue to move _____ like our diaphragm when we breathed out.

31. Jane split a celery stalk along its middle and stood the split stalk into two containers of different coloured water as shown below.

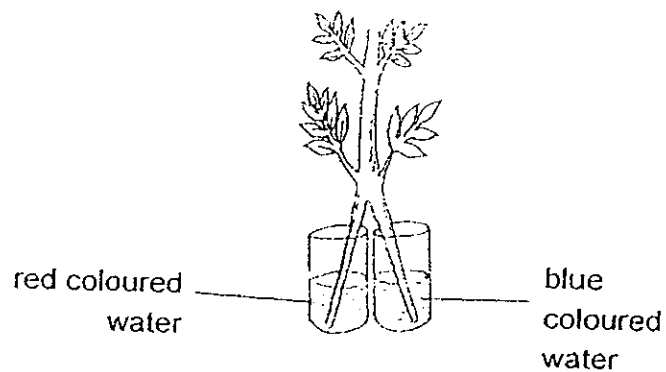

- (a) Predict what Jane would observe of the split celery stalk after 1 day. [1]

- (b) What did Jane's experiment show? stained red. [1]

32. The chart below shows the classification of some plants.

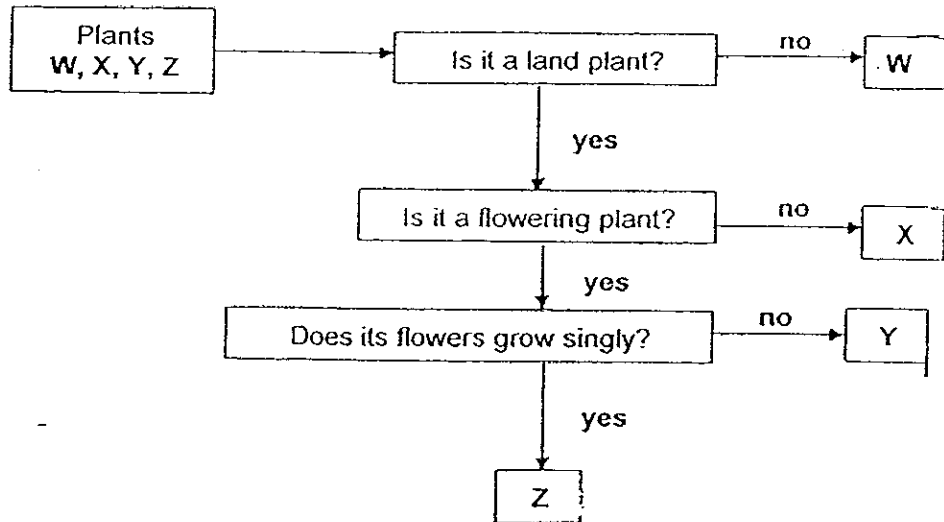

Identify plants W, X, Y and Z by using the chart above and the words in the box below.

[4]

~~ixora~~ ~~bird's nest fern~~ ~~cattail~~ ~~hibiscus~~

W: _____

X: _____

Y: _____

Z: _____

33. Peter set up the experiment shown below.

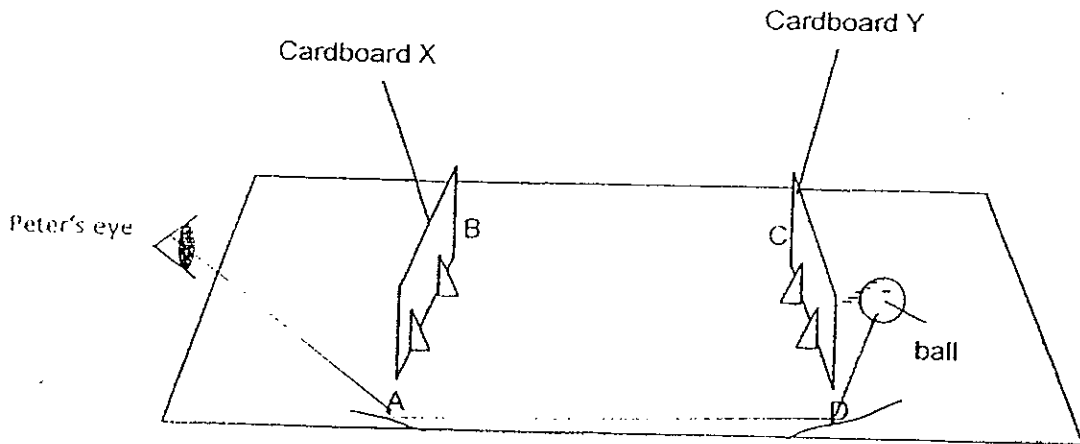

Peter stood behind cardboard X. He could **NOT** see the ball behind cardboard Y.

At which 2 positions, A, B, C or D, should Peter place the 2 mirrors such that he could see the ball?

Explain your answer.

[2]

Positions _____

34. Tom set up the apparatus as shown below to find out if the distance between the torch and ruler affects the size of the shadow formed on the screen.

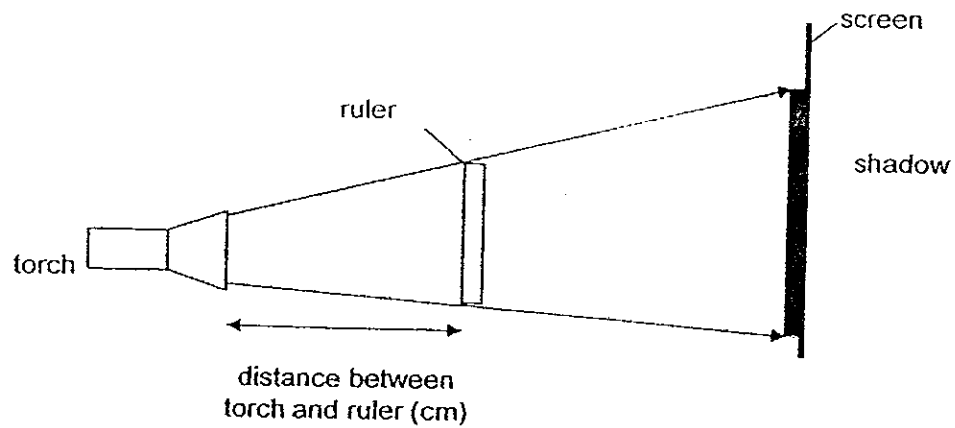

Based on the experiment above, answer the following questions:

- (a) Predict what would happen to the size of the shadow if the ruler was moved further away from the screen. [1]

- (b) What could Tom conclude? [1]

He could conclude that _____

- (c) Using the same apparatus as shown above, state **ANOTHER** way in which Tom could do to make a bigger shadow on the screen. [1]

35. Brenda set up the experiment as shown below.

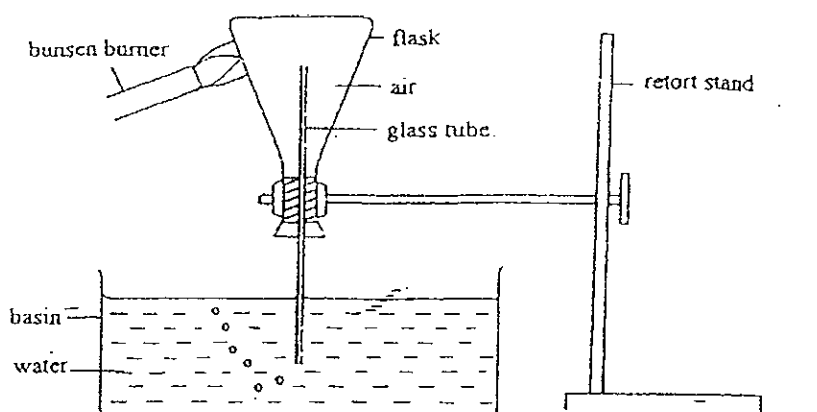

- (a) What would Brenda observe if she removed the bunsen burner after a while and the flask was allowed to cool?

Give a reason for your answer.

[2]

In **ANOTHER** experiment, Brenda heated a coin using the bunsen burner until it reached 38°C . She then dropped the coin into a glass containing water at 25°C as shown in the diagram below.

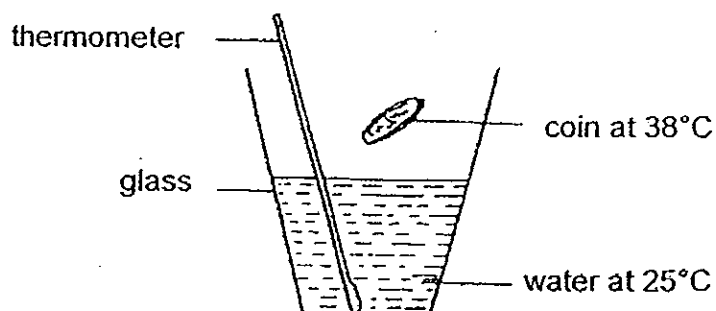

- (b) Put a tick (✓) in the correct box below to show the transfer of heat for each of the following when the heated coin was in the water. [1]

	Gained Heat	Lost Heat
water		
coin		

36. Ravi heated a beaker of water as shown in the diagram below.

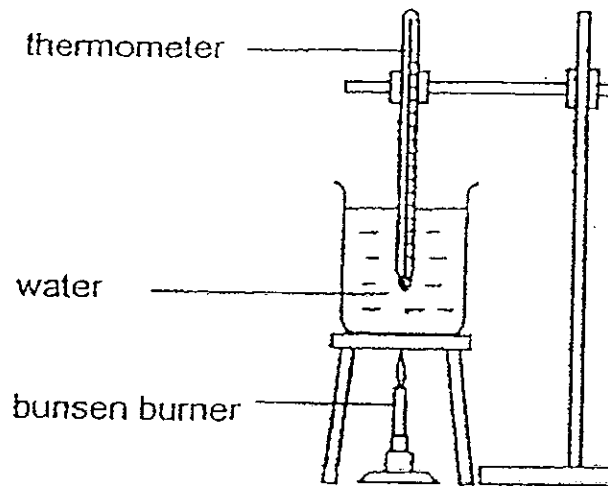

He recorded the temperature of the water and plotted the results in the graph shown below.

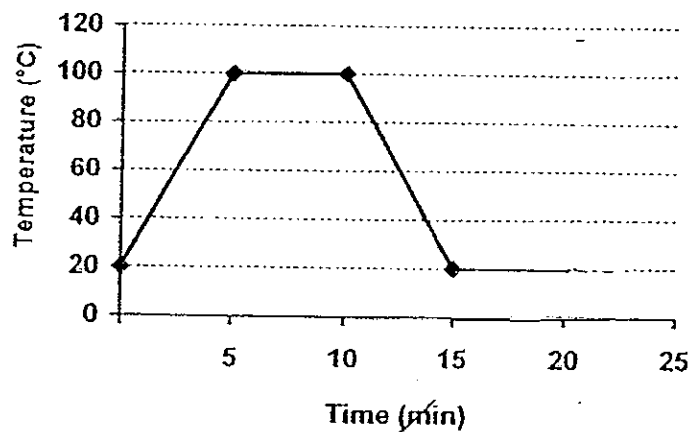

Based on the information above, answer the following questions:

- (a) What was the temperature of the water in the beaker at the 5th minute? [1]

- (b) The water in the beaker continued to boil for 5 minutes before its temperature fell.

When did the temperature of water in the beaker start to fall? [1]

The temperature of water in the beaker started to fall at the _____ minute.

(c) Give a possible reason why the temperature of the water in the beaker fell. [1]

-

-

(d) The water reached the room temperature of 20 °C at the 15th minute. The water was then left on a table for ANOTHER 5 minutes.

DRAW a line to complete the graph on page 35, extending it till the 20th minute. [1]

37. The diagram below shows a pump connected to a glass jar. The volume of the jar is 400 cm^3 . The jar contains 50 cm^3 of water.

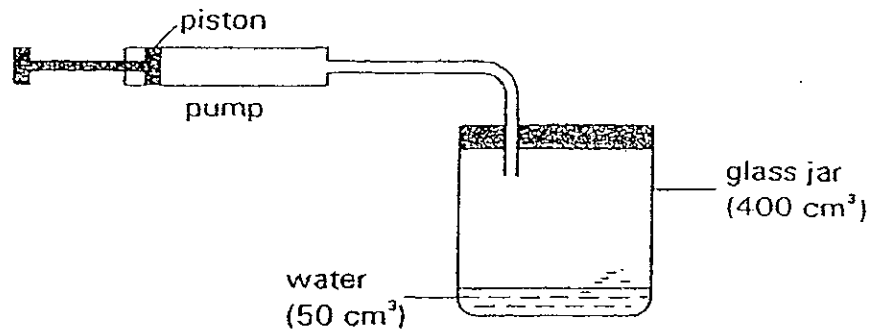

- (a) When the piston is pushed in **ONCE** completely, 30 cm^3 of air is forced into the jar. What is the volume of the air in the jar now? [1]

The mouth of a flask is attached to a balloon as shown in the diagram below.

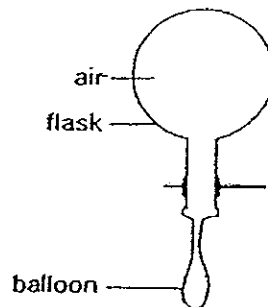

The balloon becomes inflated when part of the flask is heated by a flame after awhile.

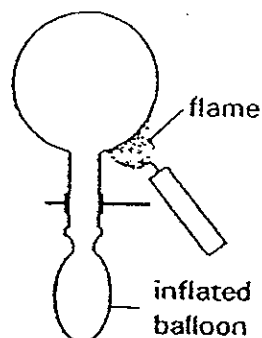

- (b) What does the experiment tell us about the property of air? [1]

38. Mary conducted an experiment shown below. She marked the initial water level in the glass tube. She then placed the set-up in a basin of hot water.

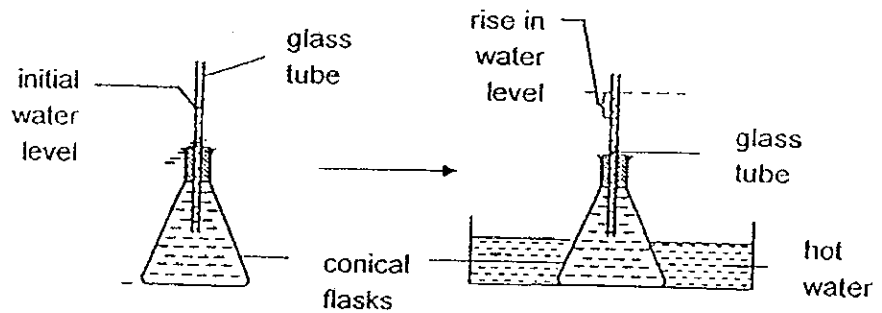

After a while, Mary observed that there was an increase in the water level in the glass tube.

- (a) Give a reason for her observation.

[1]

- (b) If Mary took the flask out of the basin of hot water and let it rest on a table for 5 minutes, what would she observe?

[1]

- (c) Give a reason for your answer in (b).

[1]

39. Siew Leng poured water into two containers as shown in the diagrams below. There was a glass tube in Set-up A but **NOT** in set-up B.

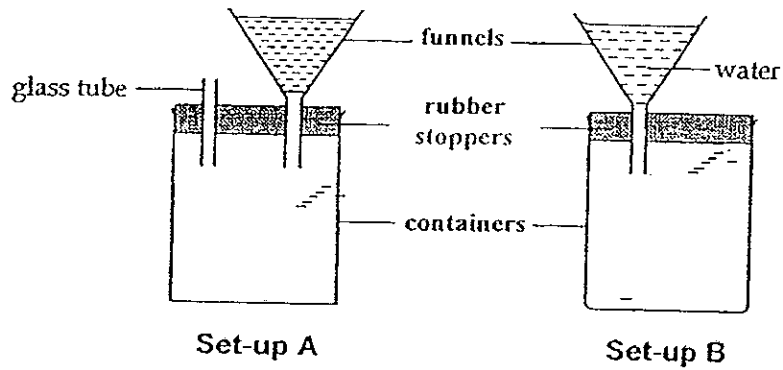

In which set-up would the water flow down more quickly?

Give a reason for your answer.

[2]

Set-up _____

40. Mary has two pieces of objects X and Y which are made of iron, as shown in the diagrams below.

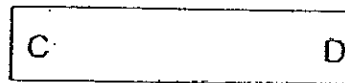
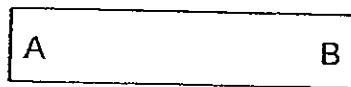

object X

object Y

When she put end B near to end C, she noticed that the objects were attracted to each other.

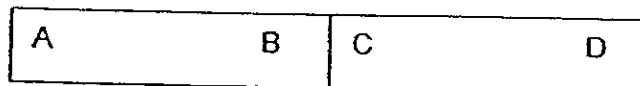

Mary concluded that both objects X and Y are magnets. Her teacher told her that her conclusion was inaccurate.

Using objects X and Y, what should Mary do to prove that they are magnets?

[2]

41. Cleo set up the following experiment to find out if the number of coils around an iron nail affects the number of pins attracted.

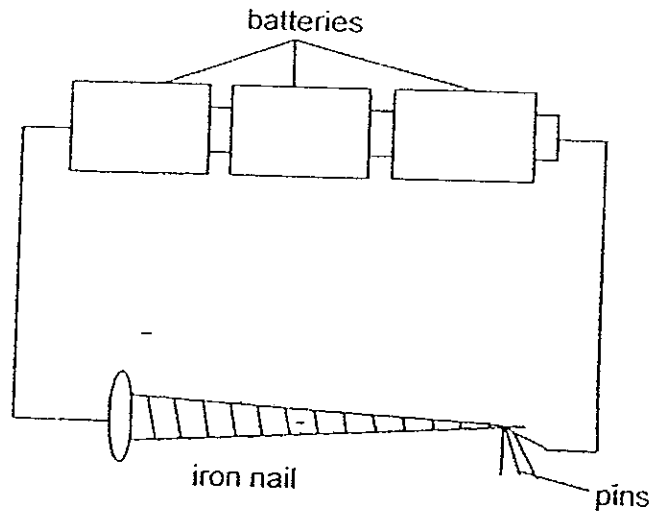

Cleo recorded her findings in the table below.

number of coils	number of pins attracted
20	4
25	6
30	9
35	11

Based on the information above, answer the following questions:

- (a) State the relationship between the number of coils around the iron nail and the number of pins it attracted. [1]

- (b) What else could Cleo do to increase the number of pins attracted to the coiled nail? [1]

- End of paper -

Setters: Mrs Anna Fong, Ms Ho Win Nie and Mdm Jane Woon

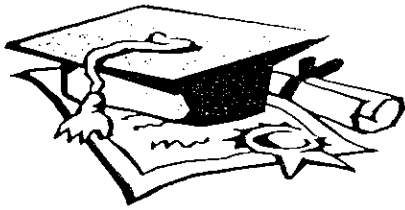

ANSWER SHEET

EXAM PAPER 2008

SCHOOL : RAFFLES GIRLS' PRIMARY SCHOOL

SUBJECT : PRIMARY 4 SCIENCE

TERM : SA 2

Q1	Q2	Q3	Q4	Q5	Q6	Q7	Q8	Q9	Q10	Q11	Q12	Q13	Q14	Q15	Q16	Q17
2	2	3	2	3	1	2	4	1	3	3	2	1	3	2	3	3

Q18	Q19	Q20	Q21	Q22	Q23	Q24	Q25
3	3	3	1	4	4	4	4

- 26)a) It prevents the mosquito from laying their eggs in the water.
 b) to prevent the eggs from hatching into wrigglers.

- 27)a) Set-up B. It is because the seeds in set-up B has water which is one of the conditions for germination.
 b) It is because the seedling had grown their leaves and are able to make food, but the locker has no light source to allow the seedling to make food, therefore, the seedling are not growing well.

28) Beaker C.

It is because beaker C's plant has roots to absorb water for photosynthesis, while beaker B's plant has no leaves to make food although it has roots and beaker A's plant has no roots to absorb water.

29)a)

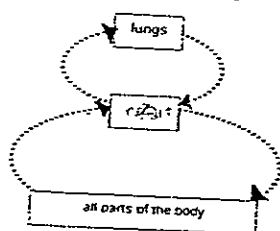

29)b) Organ Z is the heart.

c) Organ Z has to pump blood rich in oxygen to all parts of the body.

30)a) 1) move upwards 2) upwards

31)a) Tiny tubes inside the split stalk in the tube coloured water would be stained blue while the tiny tubes in the stalk which is in the red coloured water would be stained red.

b) Jane's experiment shows that the stem has tiny tubes which transport water to all parts of the plant.

32) W: cattail X: bird's nest fern Y: ixora Z: hibiscus

33) B and D.

Light from the ball reflect to mirror D which reflect to B which reflect to Peter's eyes.

34)a) The shadow on the screen would become bigger and blur.

b) He could conclude that when an object blocks most of the path of light, a big and blur shadow would be from.

c) Tom could move the screen further away from the object and light source.

35)a) The water will flow into the flask. When the air in the flask cool, it contracts the water to fill up the space in the flask.

b) Water: Gained Heat.

Coin: Lost Heat.

36)a) 100°C b) 10^{th}

c) Bunsen burner was turned off.

d)

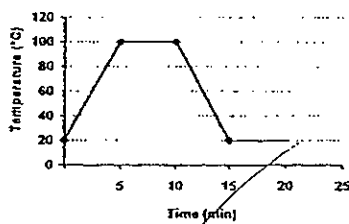

37)a)350cm³

b)Air expands when heated and occupies space.

38)a)The hot water transferred the heat to the water in the flask causing it to expand.

b)The water level in the glass tube would fall.

c)Water contracts when cooled.

39)Set-up A.

It is because there is a hole which allows air to escape when the water flows in.

40)She should put end A near to end C, if they repel then Many can prove that they are magnets.

41)a)The more coils around the iron nail, the more pins the iron nail attracted.

b)She could add more batteries.