

ELAU / YWW / KO / LYL / EC

SINGAPORE CHINESE GIRLS' SCHOOL  
SECOND SEMESTRAL ASSESSMENT 2019

PRIMARY 4  
MATHEMATICS  
BOOKLET A

Name : \_\_\_\_\_ (     )

23 October 2019

Class : Primary 4 SY/C/G/SE/P

Parent's Signature

There are 15 questions in this booklet.  
SECTION A

Total Time : 1 h 45 min (Booklet A and B)

**INSTRUCTIONS TO CANDIDATES**

DO NOT OPEN THIS BOOKLET UNTIL YOU ARE TOLD TO DO SO.

FOLLOW ALL INSTRUCTIONS CAREFULLY.

ANSWER ALL QUESTIONS.

CHECK THAT ALL MCQ ANSWERS ARE SHADED CORRECTLY IN THE OAS



**Section A: ( 30 marks )**

Questions 1 to 15 carry 2 marks each. For each question, four options are given. One of them is the correct answer. Make your choice (1, 2, 3 or 4). Shade the correct oval (1, 2, 3 or 4) on the Optical Answer Sheet.

1. Twenty-five thousand and thirteen in figures is \_\_\_\_\_.

- (1) 25 130
- (2) 25 103
- (3) 25 013
- (4) 2513

2. 49 726 rounded to the nearest hundred is \_\_\_\_\_.

- (1) 49 700
- (2) 49 730
- (3) 49 800
- (4) 50 000

3. 72 is **not** a multiple of \_\_\_\_\_.

- (1) 6
- (2) 7
- (3) 8
- (4) 9

4.  $6\frac{1}{4} = \frac{\square}{4}$  What is the missing number in the box?

- (1) 7
- (2) 11
- (3) 24
- (4) 25

5. The figure shown is made up of identical triangles. What fraction of the figure is shaded?

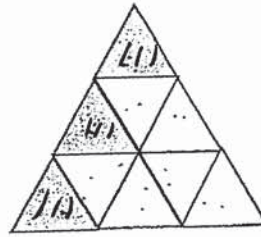

(1)  $\frac{3}{6}$

(2)  $\frac{3}{8}$

(3)  $\frac{3}{9}$

(4)  $\frac{6}{9}$

6. Which of the following decimals is the greatest?

(1) 4.09

(2) 4.108

(3) 4.063

(4) 4.21

Text

7. Express 0.75 as a fraction in its simplest form.

(1)  $\frac{3}{4}$

(2)  $\frac{3}{40}$

(3)  $\frac{5}{10}$

(4)  $\frac{5}{20}$

8. Which number below is 5.02 less than 10?

- (1) 4.8
- (2) 4.98
- (3) 15.2
- (4) 15.02

9. The total mass of Mrs. Kong and her husband is 110.8 kg. She is 30.6 kg lighter than her husband. What is Mrs Kong's mass?

- (1) 40.1 kg
- (2) 55.4 kg
- (3) 70.7 kg
- (4) 80.2 kg

10. Mrs Li cut 8 pieces of ribbon from a roll, measuring 20 m. Each piece measured 2.4 m long. Find the remaining length of the ribbon.

- (1) 0.8 m
- (2) 10.4 m
- (3) 17.6 m
- (4) 19.2 m

11. In the figure below, which angle is greater than a right angle?

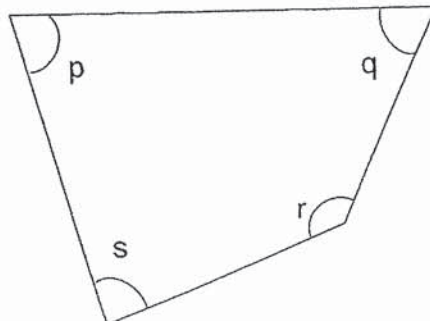

- (1) p
- (2) q
- (3) r
- (4) s

12. PQRS is a square.  $\angle PQT$  is \_\_\_\_\_  $^\circ$

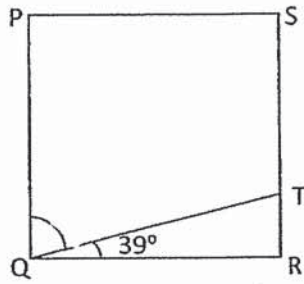

- (1) 39°
- (2) 51°
- (3) 129°
- (4) 141°

13. Which rectangle has the greatest area?

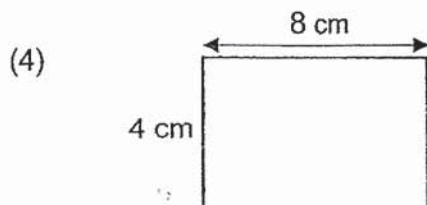
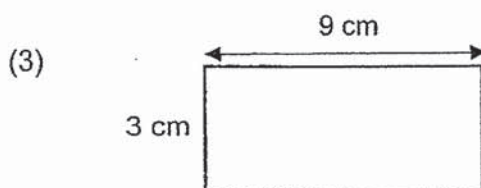
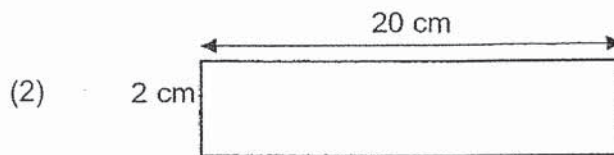
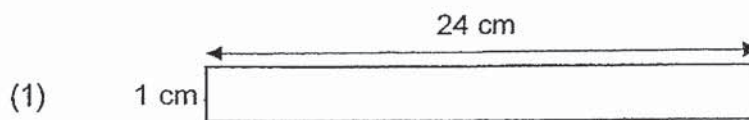

14. Mr Tan drove from Singapore to Kuala Lumpur. He started at 0920 and reached Kuala Lumpur at 1400. How long was the journey?

- (1) 3h 20 min
- (2) 3h 40 min
- (3) 4h 40 min
- (4) 5h 20 min

15 Find the value of  $\frac{7}{12} + \frac{3}{4}$ .  
Express your answer as a mixed number in its simplest form.

- (1)  $\frac{16}{12}$
- (2)  $\frac{10}{16}$
- (3)  $1\frac{2}{6}$
- (4)  $1\frac{1}{3}$

SINGAPORE CHINESE GIRLS' SCHOOL  
 SECOND SEMESTRAL ASSESSMENT 2019

PRIMARY 4  
 MATHEMATICS  
 BOOKLET B

Name : \_\_\_\_\_ ( )

23 October 2019

Class : Primary 4 SYIC/G/SE/P

		Marks attained	Max Mark
Booklet A	Section A		30
Booklet B	Section B		40
	Section C		30
Total			100

Parent's Signature

There are 28 questions in this booklet.  
 SECTION B and C

Total Time : 1 h 45 min (Booklet A and B)

**INSTRUCTIONS TO CANDIDATES**

DO NOT OPEN THIS BOOKLET UNTIL YOU ARE TOLD TO DO SO.  
 FOLLOW ALL INSTRUCTIONS CAREFULLY.  
 ANSWER ALL QUESTIONS.



**Section B: ( 40 marks )**

Questions 16 to 35 carry 2 marks each. Write your answers in the space provided. For questions which require units, give your answers in the units stated.

Do not write  
in this column

16.  $72\,508 = 70\,000 + 2000 + \underline{\hspace{2cm}} + 8$

What is the missing number?

Ans:                     

17. Write the missing number in the number pattern below.

Ans:                     

18. Some factors of 28 are 1, 2, 4 and 28. What are the other two factors of 28?

Ans :        ,       

19.  $\frac{3}{5} = \frac{6}{\square}$

Ans :                     

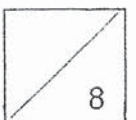

Do not write  
In this column

20. Find the value of  $1 - \frac{2}{9} - \frac{1}{3}$ .

Ans: \_\_\_\_\_

21. Find the value of  $5.83 \times 7$ .

Ans: \_\_\_\_\_

22.  $12.85 + 0.19 =$  \_\_\_\_\_

Ans : \_\_\_\_\_

23. In the figure below, name the smallest angle.

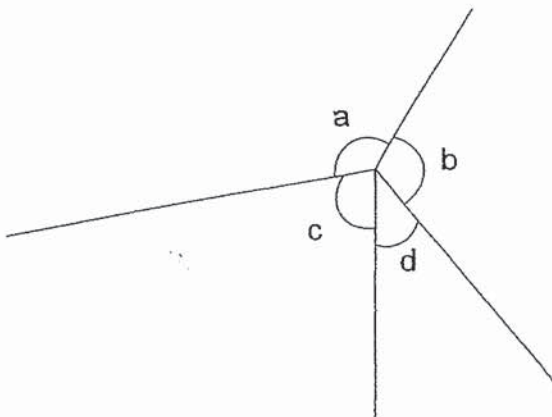

Ans :  $\angle$  \_\_\_\_\_

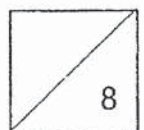

24. Measure and write down the size of  $\angle y$ .

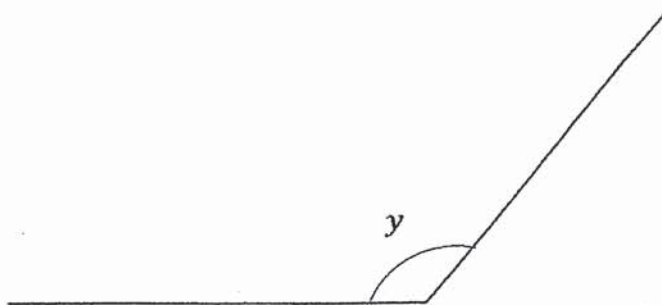

Ans: \_\_\_\_\_<sup>o</sup>

25. Five similar t-shirts cost \$102.50.  
What is the cost of one t-shirt?

Ans: \$ \_\_\_\_\_

26. Ellie and George have \$480. George has thrice as much money as Ellie.  
How much money does George have?

Ans: \$ \_\_\_\_\_

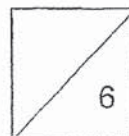

27. Mrs Li had 4 kg of flour. She used  $\frac{1}{2}$  of it to bake cookies and  $\frac{2}{3}$  kg to bake cakes. How much flour was left?

Do not write  
In this column

Ans: \_\_\_\_\_ kg

28. 7 bottles can hold as much water as 5 jars. 1 bottle can hold 0.75 l of water. How much water can 1 jar hold?

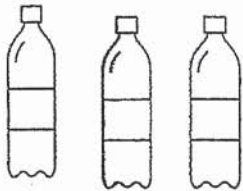
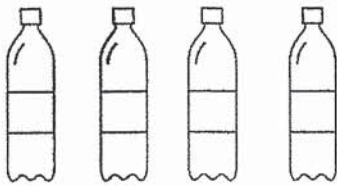

**7 bottles**



**5 jars**

Ans: \_\_\_\_\_ l

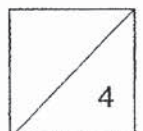

29. The figure below is made up of 3 identical rectangles. The length of each rectangle is twice its breadth. The total perimeter of the figure is 80 cm. What is the length of each rectangle?

Do not write  
In this column

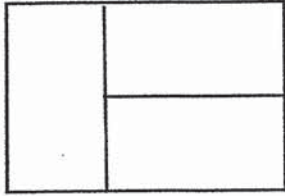

Ans: \_\_\_\_\_ cm

30. Complete the diagram below to form a symmetric figure. The dotted line is the line of symmetry. Draw the other half.

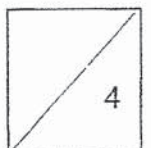
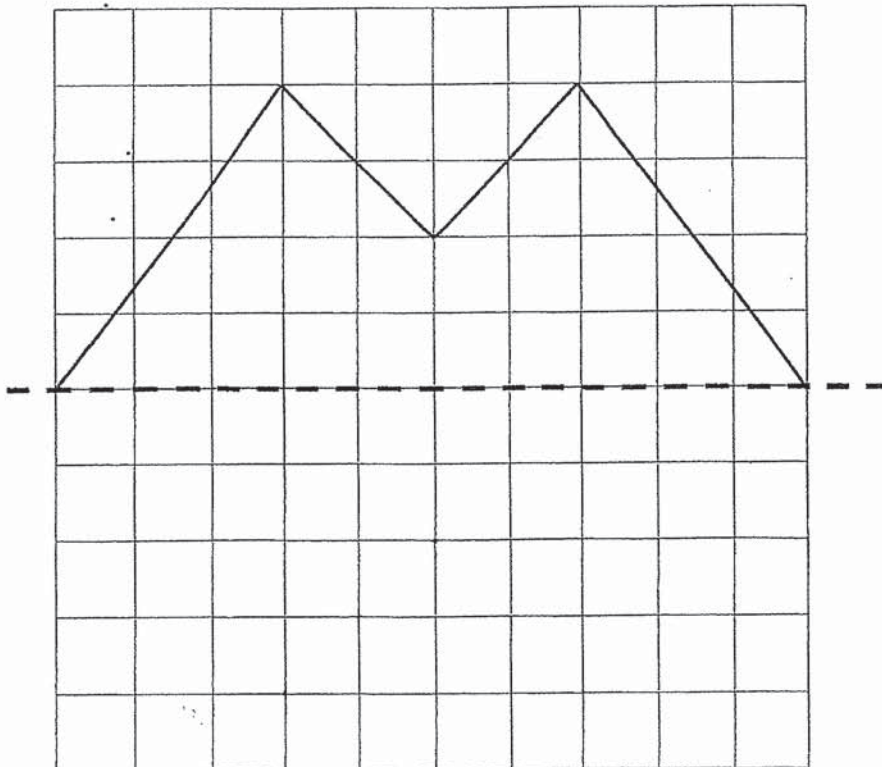

31. Tom wanted to watch a movie that started at 12.50 pm. He arrived at the theatre 35 minutes late. What time did he arrive at the theatre?

Do not write  
In this column

Ans: \_\_\_\_\_ p.m.

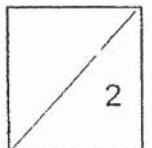

The bar graph below shows the number of shoes sold at Tom's shop.

Answer Questions 32 and 33.

Pairs of shoes sold in Tom's shop

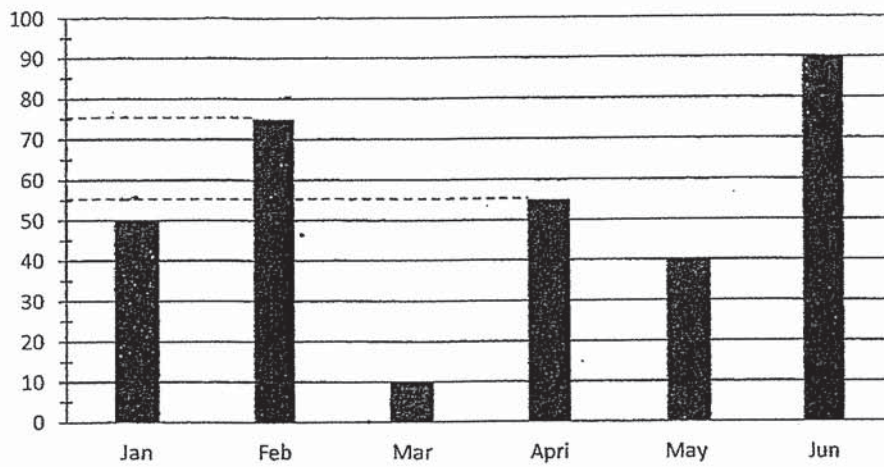

32. In January, Tom sold \_\_\_\_\_ times as many pairs of shoes as in March.

Ans: \_\_\_\_\_

33. Each pair of shoes was sold for \$30. How much did he earn for the month when he sold the most number of shoes?

Ans: \$ \_\_\_\_\_

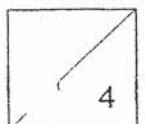



The line graph below shows survey results of the favourite snacks of some children. Use the graph to answer questions 34 and 35.

Do not write  
in this column

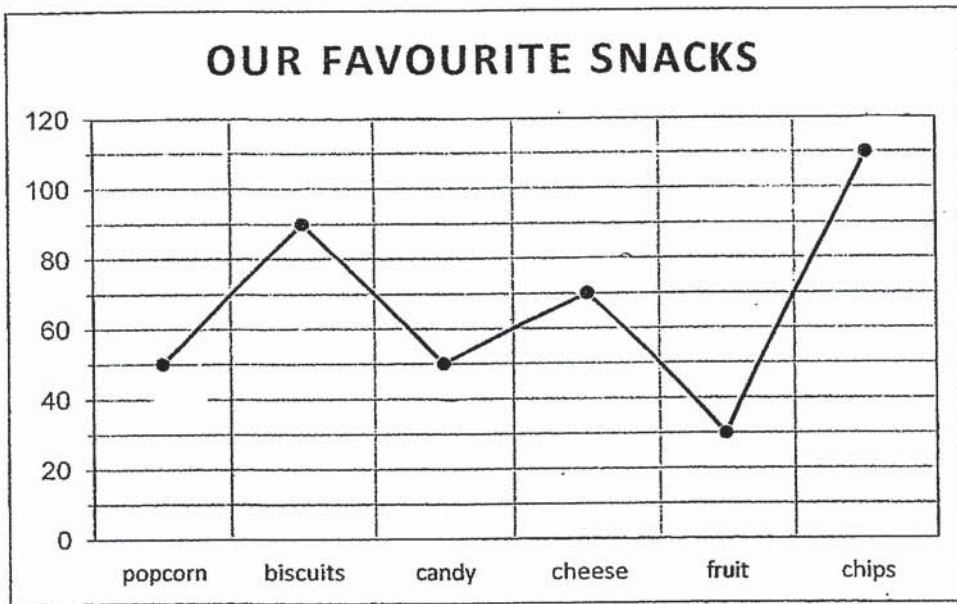

34. How many children took part in the survey?

Ans : \_\_\_\_\_

35. Which **2 snacks** have the same total number of votes as popcorn and candy?

Ans : \_\_\_\_\_ and \_\_\_\_\_

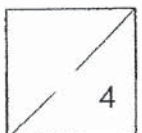



**Section C: ( 30 marks )**

For questions 36 to 43, show your working clearly in the space provided for each question and write your answer in the space provided.

The number of marks available is shown in brackets [ ] at the end of each question or part-question.

36. Peter had \$530. Ahmad had \$80 less than Peter. Bob had \$160 more than Ahmad. How much did Bob have?

Ans: \_\_\_\_\_ [ 3 ]

37. Paul lost  $\frac{3}{8}$  of his marbles in a game and had 565 marbles left. How many marbles did he have at first?

Ans: \_\_\_\_\_ [ 3 ]

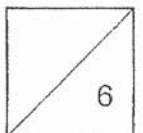

38. Mr Wong had 6 crates of equal number of peaches. He repacked them into 8 baskets. Each basket can hold 49 peaches. 22 peaches could not be packed into the baskets. How many peaches were there in 1 crate?

Do not write  
in this column

Ans : \_\_\_\_\_ [4]

39. Look at the diagram below.

- a) What is the distance between the 2<sup>nd</sup> and 9<sup>th</sup> lamp posts?  
b) How many lamp posts will there be if the total distance between the first and the last lamp post is 280 m?

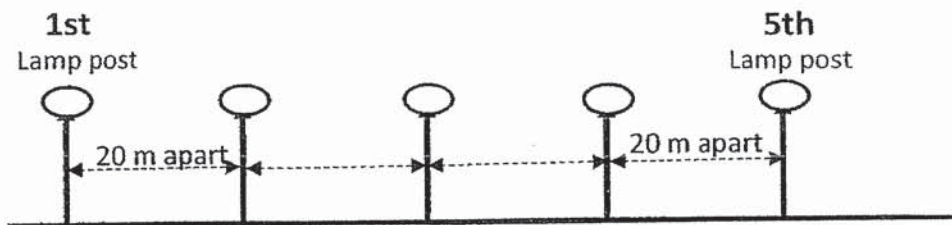

Ans : (a) \_\_\_\_\_ [2]

(b) \_\_\_\_\_ [2]

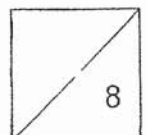

40. Katie had thrice as much money as Alan. When Alan gave \$20 to his brother, Katie would have 5 times as much money as Alan. How much did Katie have?

Do not write  
In this column

Ans: \_\_\_\_\_ [ 4 ]

41. Lily is  $\frac{3}{7}$  of her mother's age. Her mother is 49 years old now. In how many year's time will their total age be 100 years?

Ans: \_\_\_\_\_ [ 4 ]

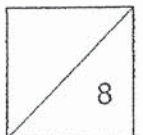

42. Oranges are sold at \$1.50 each or 3 oranges for \$3.45. What is the most number of oranges James can buy with \$10?

Do not write  
in this column

Ans : \_\_\_\_\_ [4]

12

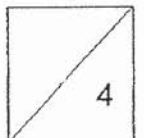

43. In the figure below, a rectangle is folded as shown.  
Find the area of the rectangle.

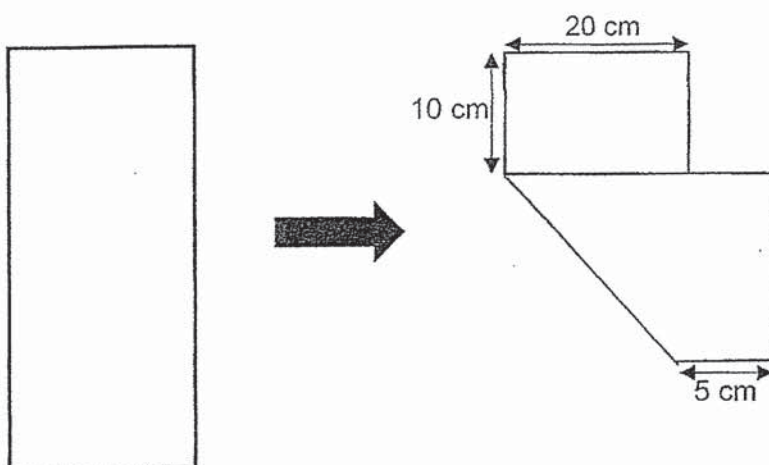

Ans: \_\_\_\_\_ [4]

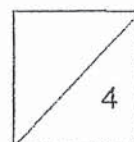

END OF PAPER



# ANSWER KEY

**YEAR : 2019**  
**LEVEL : PRIMARY 4**  
**SCHOOL : SINGAPORE CHINESE GIRLS' SCHOOL**  
**SUBJECT : MATHEMATICS**  
**TERM : SA2**

## PAPER ONE : BOOKLET A

<b>Q1</b>	<b>Q2</b>	<b>Q3</b>	<b>Q4</b>	<b>Q5</b>	<b>Q6</b>	<b>Q7</b>	<b>Q8</b>
3	1	2	4	3	4	1	2
<b>Q9</b>	<b>Q10</b>	<b>Q11</b>	<b>Q12</b>	<b>Q13</b>	<b>Q14</b>	<b>Q15</b>	
1	1	3	2	2	3	4	

## PAPER ONE : BOOKLET B

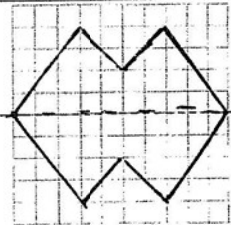
<b>Q16</b>	500
<b>Q17</b>	4099
<b>Q18</b>	7, 14
<b>Q19</b>	10
<b>Q20</b>	$\frac{9}{9} - \frac{2}{9} - \frac{3}{9} = \frac{4}{9}$
<b>Q21</b>	$5.83 \times 7 = 40.81$
<b>Q22</b>	$12.85 + 0.19 = 13.04$
<b>Q23</b>	<d
<b>Q24</b>	130°
<b>Q25</b>	$\$102.50 \div 5 = \$20.50$
<b>Q26</b>	E : G $\rightarrow$ 1 : 3 4u $\rightarrow$ \$480 3u $\rightarrow$ $\$480 \div 4 \times 3 = \$360$
<b>Q27</b>	$4 \div 2 = 2\text{kg}$ $2 - \frac{2}{3} = 1\frac{1}{3}\text{kg}$
<b>Q28</b>	$0.75 \times 7 = 5.25$ $5.25 \div 5 = 1.05\text{l}$
<b>Q29</b>	Length : Breadth $\rightarrow$ 3u : 2u 10u $\rightarrow$ 80 1u $\rightarrow$ $80 \div 10 = 8$ 2u $\rightarrow$ $8 \times 2 = 16$
<b>Q30</b>	



Q31	10 min	25min					
	12 50	13 00				13 25	
	Ans: 1.25 p. m.						
Q32	$50 \div 10 = 5$						
Q33	Jun $\rightarrow 90 \times \$30 = \$2700$						
Q34	$50 + 90 + 50 + 70 + 30 + 100 = 400$						
Q35	$50 + 50 = 100$ Ans: Cheese and fruit ( $30 + 70 = 100$ )						
Q36	$\$530 - \$80 + \$160 = \$610$						
Q37	$5u \rightarrow 565$ $1u \rightarrow 565 \div 5 = 113$ $8u \rightarrow 113 \times 8 = 904$ marbles						
Q38	8 buckets $\rightarrow 49 \times 8 = 392$ Total $\rightarrow 392 + 22 = 414$ Ans $\rightarrow 414 \div 6 = 69$ peaches						
Q39	(a) 7 gaps $\times 20m = 140m$ (b) $280 \div 20 = 14$ ANS(b) $\rightarrow 14 + 1 = 15$						
Q40	K	1u	1u	1u	20	20	20
	A	1u	20				
	$4u = 2u + 60$ $2u = 60$ $1u = 30$ Katie = $30 \times 3 + 60 = 150$ Ans $\rightarrow 150$						
Q41	$7u = 49$ $1u = 7$ Lily = $7 \times 3 = 21$ $21 + 49 = 70$ (total now) $100 - 70 = 30$ $30 \div 2 = 15$						
Q42	$\$3.45 \times 2 = \$6.90$ $\$1.50 \times 2 = \$3.00$ Total $\rightarrow (2 \times 3) + 2 = 8$ oranges						
Q43	Length $\rightarrow 10 + 20 + 5 = 35cm$ Area $\rightarrow 35 \times 20 = 700cm^2$						

2  
END