



Rulang Primary School

END OF YEAR EXAMINATION SCIENCE 2022

Name: _____ () Marks: _____ / 60

Level: Primary 4 Total Time for Booklets

Class: Primary 4 () A and B: 1 h 30 min

Setter: Ms Maslishah Punari Date: 1 Nov 2022

Total Marks:

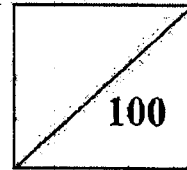

31.5

BOOKLET A

Instructions to pupils:

1. Do not open this booklet until you are told to do so.
2. You are required to answer **all** the questions in this booklet.
3. This question booklet consists of 17 printed pages, including the cover page.

Section A (30 x 2 marks)

For each of the questions from 1 to 30, four options are given. One of them is the correct answer. Make your choice (1, 2, 3 or 4). **Shade the correct oval (1, 2, 3 or 4) on the Optical Answer Sheet.**

1. Matter is anything that has mass and occupies space. Which one of the following is not matter?

- (1) Air
- (2) Soil
- (3) Water
- (4) Shadow

2. Which one of the following properties is true for both air and a book?

- (1) They can be seen.
- (2) They take up space.
- (3) They have definite shapes.
- (4) They have definite volumes.

3. The diagram below shows a plant.

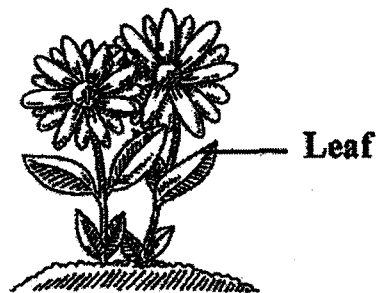

The leaf helps the plant to _____.

- (1) make food
- (2) absorb water
- (3) grow upright
- (4) absorb nutrients

4. In which part of the digestive system is food absorbed into the blood?

- (1) Gullet
- (2) Stomach
- (3) Small intestine
- (4) Large intestine

5. The diagram below shows the life cycle of a plant.

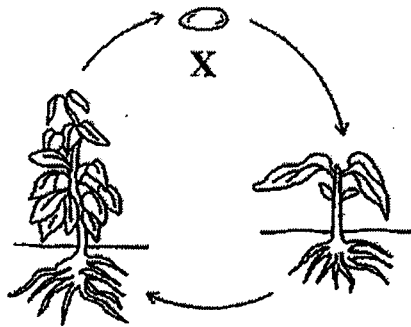

What is the stage marked X?

- (1) Egg
 - (2) Seed
 - (3) Adult plant
 - (4) Young plant
6. Adam places a metal spoon into a cup of hot water.

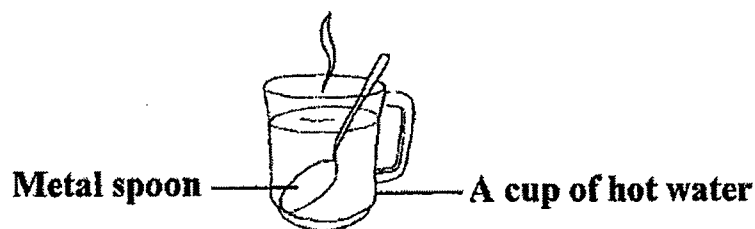

The spoon becomes hot after a while. Which one of the following explains this?

- (1) The cup loses heat to the hot water.
- (2) The spoon loses heat to the hot water.
- (3) The hot water gains heat from the spoon.
- (4) The spoon gains heat from the hot water.

7. A mimosa plant closes when we touch its leaves.

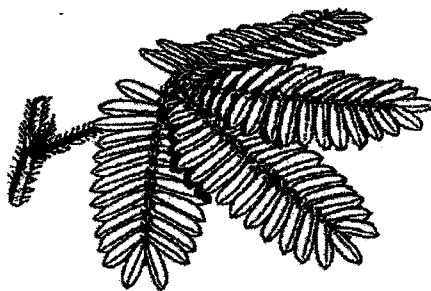

This shows that the mimosa plant is a living thing because it can _____.

- (1) grow
 - (2) breathe
 - (3) reproduce
 - (4) respond to changes around it
8. Which one of the following is a source of light?

(1)



A banana

(2)



The crescent moon

(3)

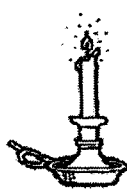

A candle flame

(4)



A leaf

9. The set-up below shows light shining on an iron ball.

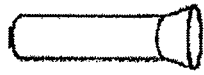

Torchlight



Iron ball



Screen

Which one of the following would likely be seen on the screen?

(1)

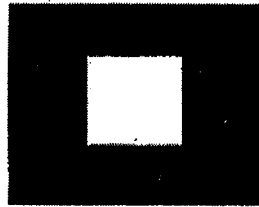

(2)

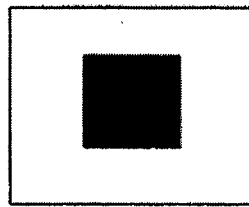

(3)

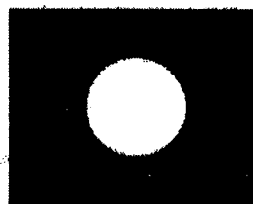

(4)

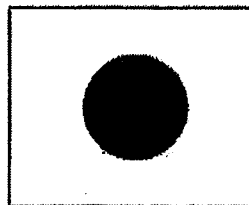

10. The diagram below shows a painting hung on a wall.

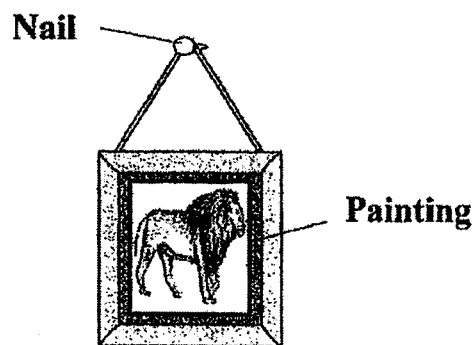

The nail is made of iron because iron _____.

- (1) is shiny
- (2) is strong
- (3) sinks in water
- (4) conducts heat well

11. Luke carried out the experiment shown below in a dark room.

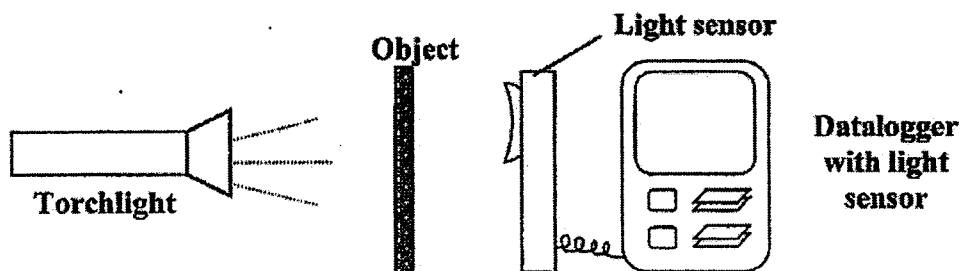

He used three different objects, A, B and C, and recorded the readings in the table below using the light sensor.

Objects	Amount of light detected by the light sensor (Unit)
A	45
B	0
C	110

He wrote down a few conclusions below based on the readings.

- A: Object A is most likely an opaque material.
- B: Object B does not allow light to pass through.
- C: Object C allows more light to pass through it than object B.
- D: Object A allows less light to pass through it than object C.

Which of the following conclusions are correct?

- (1) A, B and C only
- (2) A, B and D only
- (3) A, C and D only
- (4) B, C and D only

14. The table below shows four different human body systems.

System	Parts of the system
Digestive	Mouth, stomach, gullet, small intestine, large intestine
Respiratory	Heart, blood vessels, blood
Circulatory	Lungs, nose, windpipe
Skeletal	Rib, backbone, skull

Which two of the following systems do not show the parts that make up the system correctly?

- (1) Digestive and respiratory systems
 (2) Respiratory and circulatory systems
 (3) Circulatory and skeletal systems
 (4) Digestive and skeletal systems
15. What is the main function of the large intestine?
- (1) It removes digested food from the body.
 (2) It removes undigested food from the body.
 (3) It allows digested food to be passed into the blood.
 (4) It absorbs water and minerals from the undigested food.
16. A, B and C describe how a seed develops into a young plant.

Letter	Descriptions
A	Shoot appears
B	Roots appear
C	First leaves appear

Which one of the following shows the correct order of the development?

- (1) A → B → C (2) B → A → C
 (3) B → C → A (4) C → A → B
17. Temperature is a measure of the _____.
- (1) amount of matter of an object
 (2) degree of hotness of an object
 (3) amount of heat lost by an object to contract
 (4) amount of heat taken in by an object to expand

18. Walter poured hot water into a beaker and left it on a wooden tabletop in the living room as shown below.

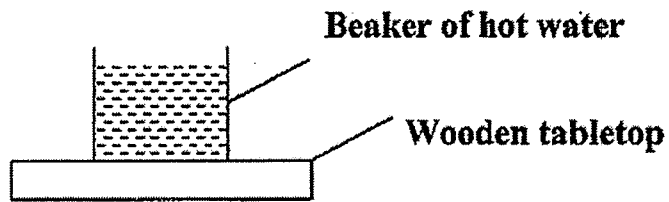

Which one of the following shows the heat flow correctly?

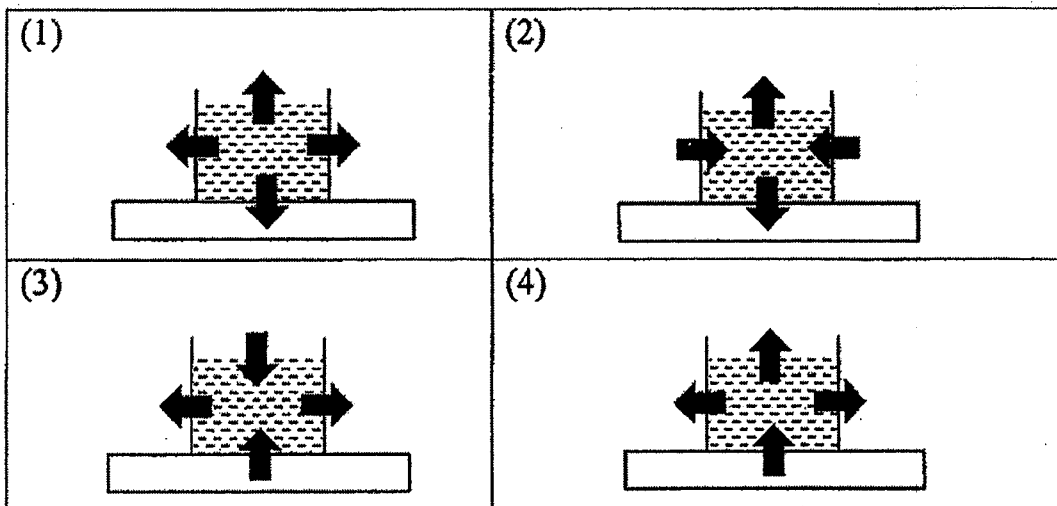

19. The diagram below shows four identical drops of wax, A, B, C and D, stuck on a rod. The rod is then heated by a Bunsen burner placed at the position shown below.

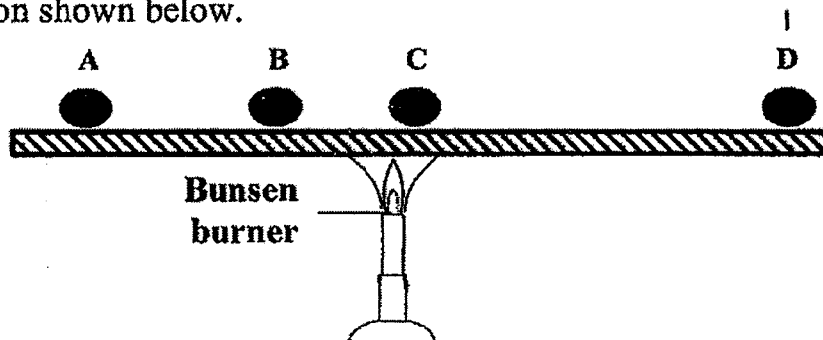

Arrange the order in which the drops of wax melt, starting with the slowest.

- (1) A → B → C → D
 (2) C → B → A → D
 (3) D → A → B → C
 (4) D → B → A → C

20. A metal block was heated for twenty minutes. A pair of tongs was then used to dip the metal block in a beaker of ice water.

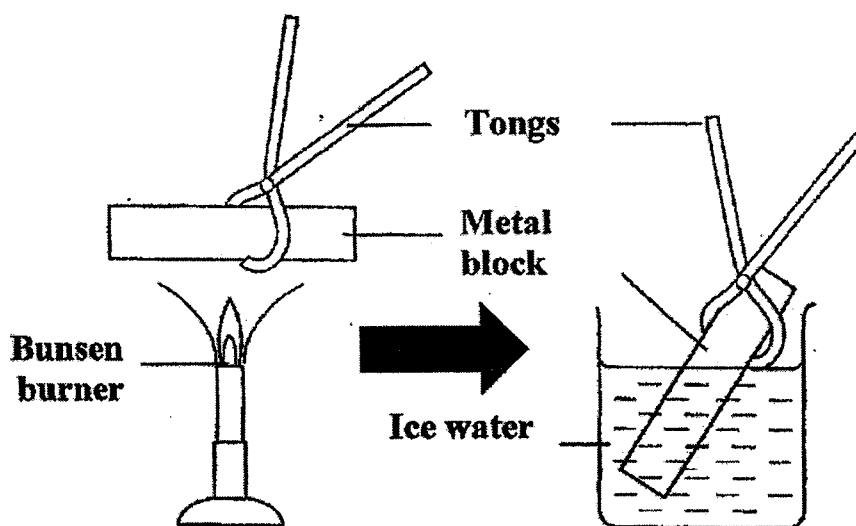

Which of the following statements are true after the metal block was dipped in a beaker of water?

- A: The metal block would become warmer.
- B: Heat would flow from the metal block to the water.
- C: The metal block and water would have the same temperatures after one day.
- D: The temperature of the water would increase as it gained heat from the metal block.

- (1) A and C only
- (2) C and D only
- (3) A, B and D only
- (4) B, C and D only

21. Josh poured different volumes of water at 80°C into four identical beakers, W, X, Y and Z, as shown in the diagram below. He then put them in the refrigerator.

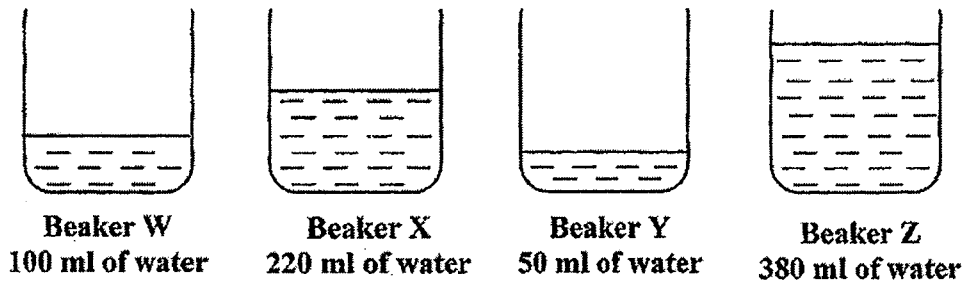

He recorded the time taken for each beaker of water to reach 5°C in the table below.

Beaker	W	X	Y	Z
Time taken for water to reach 5°C (min)	14	25	6	36

What was Josh trying to find out from his experiment?

- (1) To find out if the type of beaker affects how fast the water gains heat.
 - (2) To find out if the type of beaker affects how fast the water loses heat.
 - (3) To find out if the volume of water affects how fast the water gains heat.
 - (4) To find out if the volume of water affects how fast the water loses heat.
22. Sam poured some water into a glass and added a few ice cubes in it as shown in the diagram below. When he held the glass, his hand felt cold.

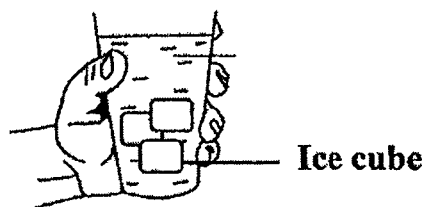

Which one of the following statements correctly explains what happened?

	Glass	Sam's hand
(1)	Lost heat to the water	Gained heat from the glass
(2)	Lost heat to the water	Lost heat to the glass
(3)	Gained heat from the water	Gained heat from the glass
(4)	Gained heat from the water	Lost heat to the glass

23. Tina filled two similar beakers, X and Y, with the same amount of water at 70°C at the start of the experiment. She then covered beaker X with material A as shown in the diagram below.

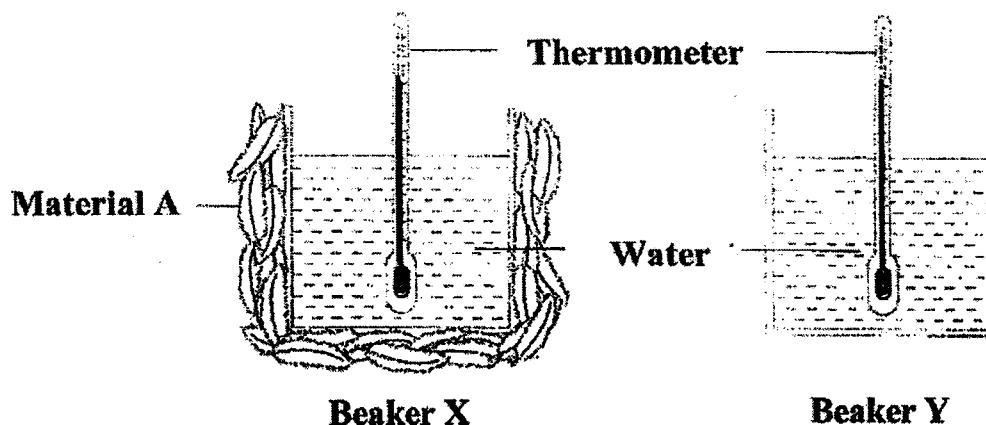

After 25 minutes, Tina recorded the temperatures of the water in both beakers in the table below.

	Temperature of water at the start of the experiment ($^{\circ}\text{C}$)	Temperature of water after 25 minutes ($^{\circ}\text{C}$)
Beaker X	70	45
Beaker Y	70	30



Based on the results in the table above, what can you conclude from the experiment?

- (1) Material A used in beaker X is a poor conductor of heat.
- (2) Material A used in beaker X is a good conductor of heat.
- (3) The water in both beakers gained heat from the surroundings.
- (4) The water in beaker Y took a longer time to lose heat to the surroundings.

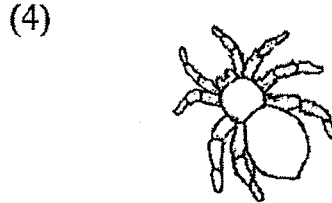
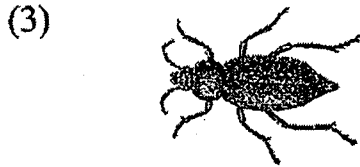
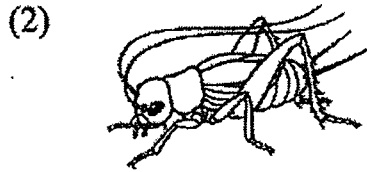
24. Which one of the animals shown below is not an insect?



25. The living things shown below have common characteristics.

		
<p>Moss</p>	<p>Bracket fungus</p>	<p>Staghorn fern</p>

All of them _____.

- (1) are green
- (2) reproduce by spores
- (3) only need water to grow
- (4) do not need sunlight to grow

26. Rose wanted to find out if the size of a magnet would affect its magnetism. She prepared two set-ups, A and B, as shown in the diagram below. She then lowered the two magnets to the heights shown below and observe the number of paper clips attracted.

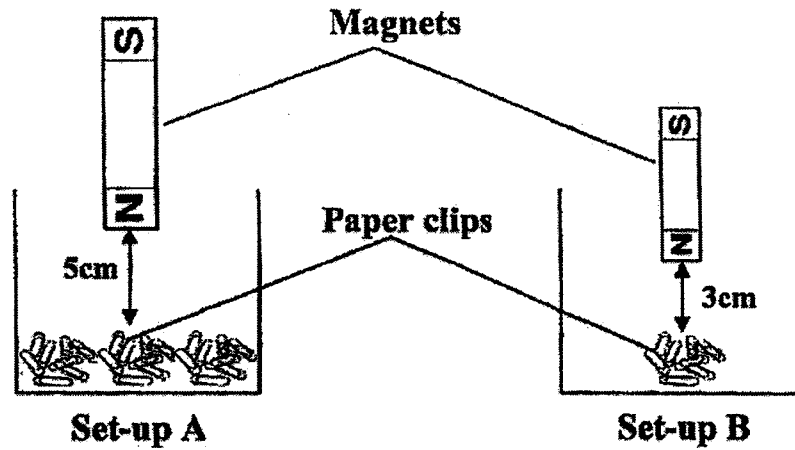

Based on both set-ups above, which of the following should be done to ensure that the test is fair?

- A: The size of the magnets should be the same.
 B: The number of paper clips should be the same.
 C: The distance between the paper clips and the magnets should be the same.

- (1) A and B only
 (2) A and C only
 (3) B and C only
 (4) A, B and C

27. Four different objects, P, Q, R and S, were placed on a transparent glass tabletop in a dark room as shown in the diagram below. The shadows of the four objects were cast onto the ground when the lamp was switched on.

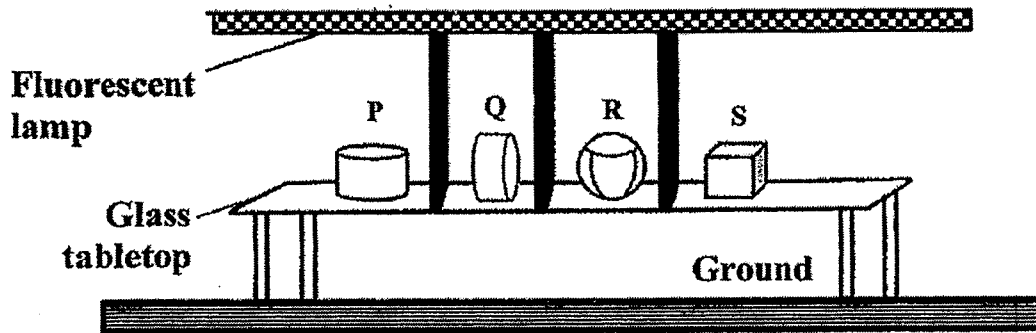

Based on the diagram above, which one of the following sets correctly shows the shadows cast on the ground?

	P	Q	R	S
(1)				
(2)				
(3)				
(4)				

28. The diagram below shows a helmet that is worn by a construction worker.

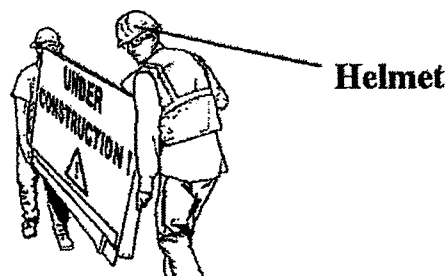

Plastic is used to make the helmet because it _____.

- (1) is strong
- (2) is flexible
- (3) is able to float on water
- (4) does not allow light to pass through it

29. Cayden set up an experiment with container P as shown in the diagram below and recorded the temperature of the water at the start of the experiment and three hours later. He then conducted the same experiment using containers Q, R and S which were of the same size and thickness as container P but made of different materials.

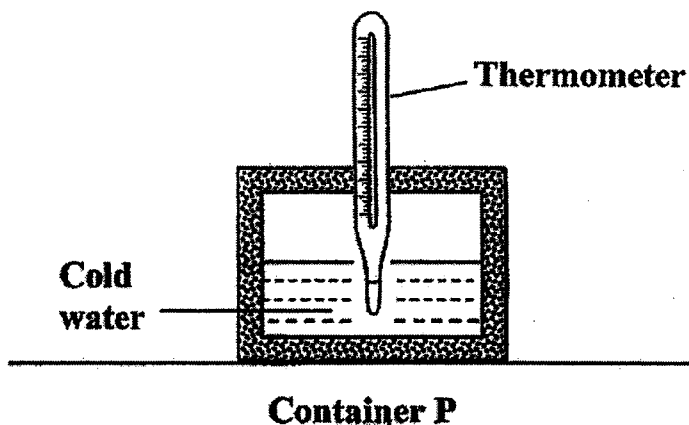

Cayden's results are shown in the table below.

Container	Temperature of water ($^{\circ}\text{C}$)	
	At the start of the experiment	Three hours later
P	5	10
Q	5	18
R	5	25
S	5	14

Instead of cold water, Cayden used hot water for his next experiment. Based on the results above, can you predict which container would allow hot water to lose the most amount of heat in the shortest time?

- (1) P
- (2) Q
- (3) R
- (4) S

30. Jayden had four strips made of different materials, A, B, C and D. He dipped each of them into a beaker of water for five minutes as shown below.

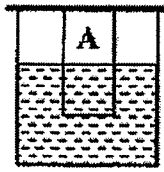

Set-up 1

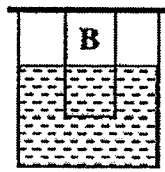

Set-up 2

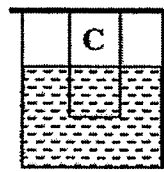

Set-up 3

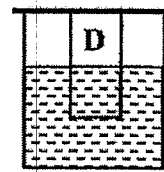

Set-up 4

He then removed the strips and measured the volume of water left in each beaker. He recorded his observations in the table below.

Time (min)	Volume of water (cm ³)			
	Set-up 1	Set-up 2	Set-up 3	Set-up 4
0	30	30	30	30
5	30	26	28	29

Based on his observations in the table above, which material is most suitable for making a towel?

- (1) A
- (2) B
- (3) C
- (4) D

Section B (40 marks)

Write your answers to questions 31 to 44 in this booklet.

31. The diagram below shows a cup of hot tea.

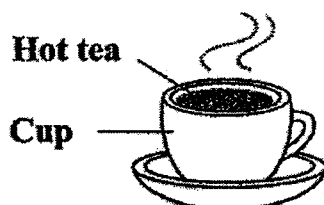

Circle the correct state for the following things.

- (a) Hot tea: Solid / Liquid / Gas [1]
- (b) Cup: Solid / Liquid / Gas [1]

32. The diagram below shows the human digestive system.

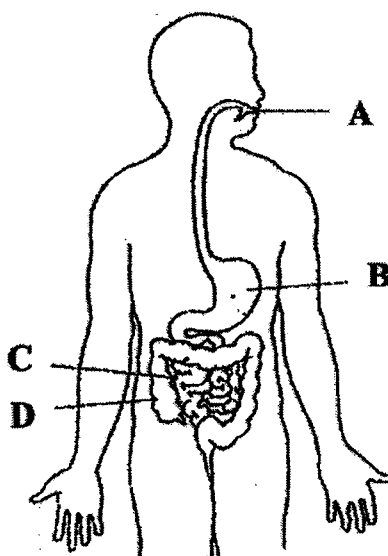

Identify the part where:

- (a) digestion first takes place: _____ [1]
- (b) there is no digestion: _____ [1]

33. James placed a metal rod and a plastic rod in a tank of boiling water as shown below. Equal amounts of wax were put on both rods.

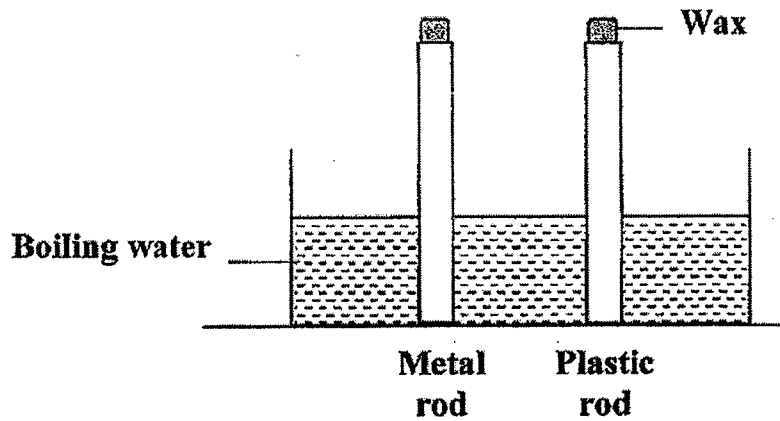

What would he observe and why?

The wax on the metal rod melted _____ than the wax on the plastic rod, as metal is a _____ conductor of heat than plastic. [2]

34. Study the diagram below.

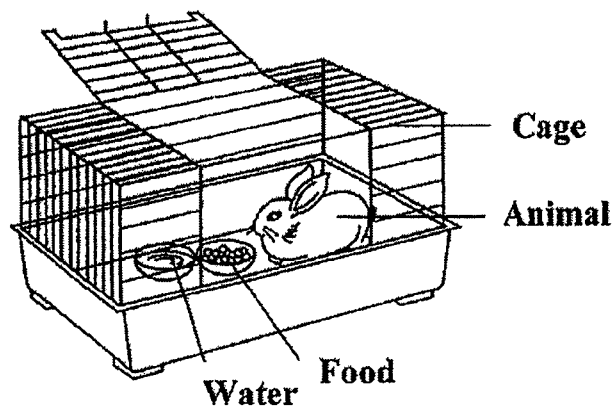

- (a) After a few days, will the amount of food in the bowl increase, decrease or remain the same? [1]

- (b) Based on the diagram above, name one substance this animal needs in order to remain alive. [1]

35. Leena shines a torch on a ball and a shadow is formed on a screen.



Torchlight



A ball

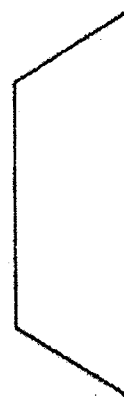

Screen

- (a) A shadow is formed when light is _____ by an object. [1]
- (b) Draw the shadow of the ball that is formed on the screen. [1]

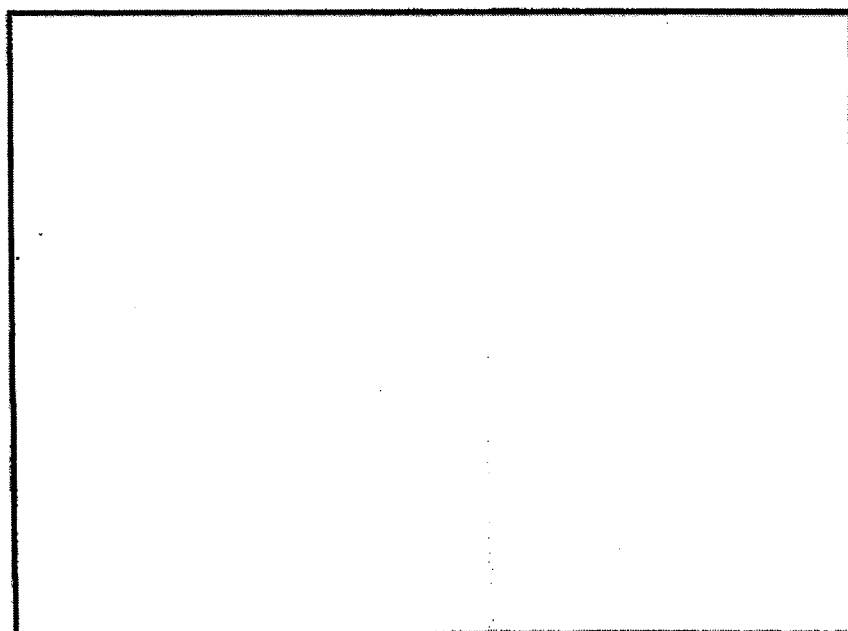

36. Shawn positioned a block of wood in a dark room and shone a torch at it from position A. He moved the torchlight slowly from positions A to C as shown in the diagram below.

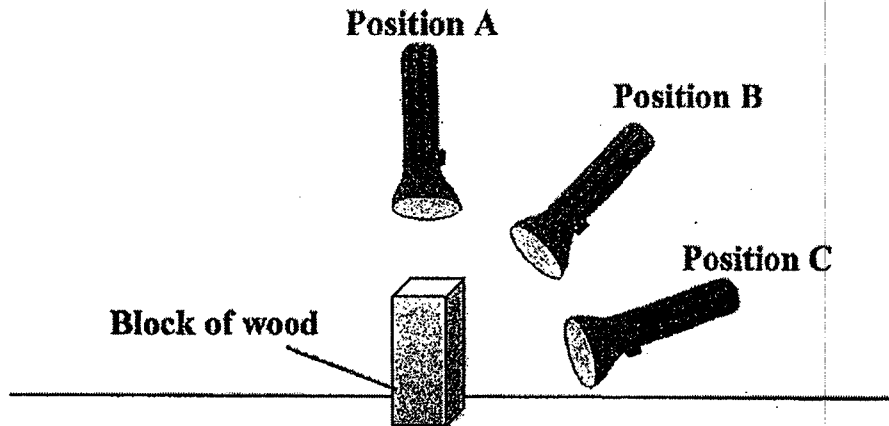

He recorded the length of the shadows cast on the ground at various positions in the table below.

Position	Length of shadow
A	0cm
B	7cm
C	12cm

- (a) Would a shadow be formed when Shawn switched off the torchlight? Explain your answer. [1]

- (b) The length of the shadow at position A was 0cm. Why was that so? [1]

- (c) What happened to the length of the shadows as the torchlight moved from positions B to C? [1]

37. Jenny wanted to find out if the number of leaves on a plant affects the amount of water the plant absorbs. She set up an experiment using three different plants, P, Q and R, placed in a bottle of water each. At the end of the experiment, she recorded her results in the table below.

Plant	Number of leaves	Amount of water absorbed
P	13	25 ml
Q	18	30 ml
R	25	40 ml

- (a) Based on the results in the table above, how does the number of leaves on the plant affect the amount of water it absorbs? [1]

- (b) Jenny conducted another experiment using two similar plants, X and Y, in her garden. She removed all the roots on plant X. Then she planted plant X back in the soil.

Explain what would happen to plants X and Y after one month. [2]

38. Study the human digestive system shown below.

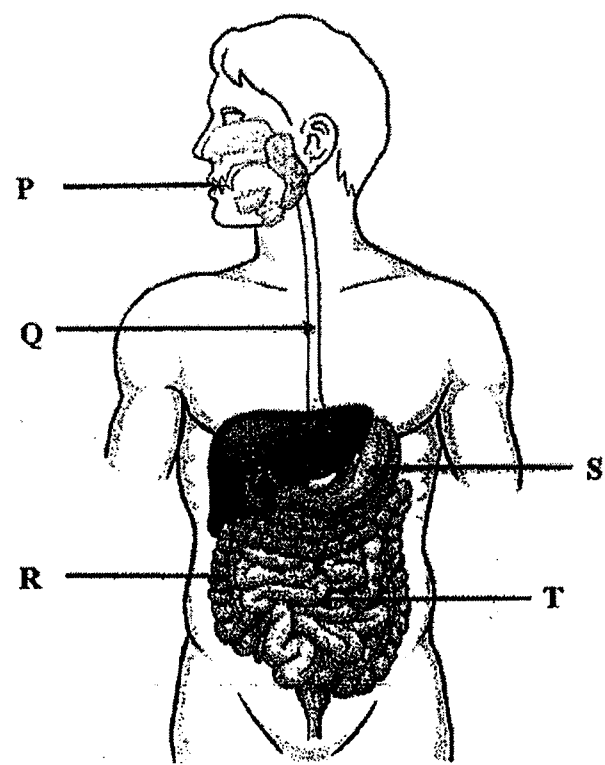

(a) In which parts, P, Q, R, S or T, are digestive juices present to break down food into simpler substances? [1]

(b) Undigested food enters an organ after leaving the small intestine. Name this organ and state its main function. [2]

Total Score on this page:

39. Leila placed some green bean seeds in two separate containers with cotton wool as shown below. She then placed both containers in a cupboard.

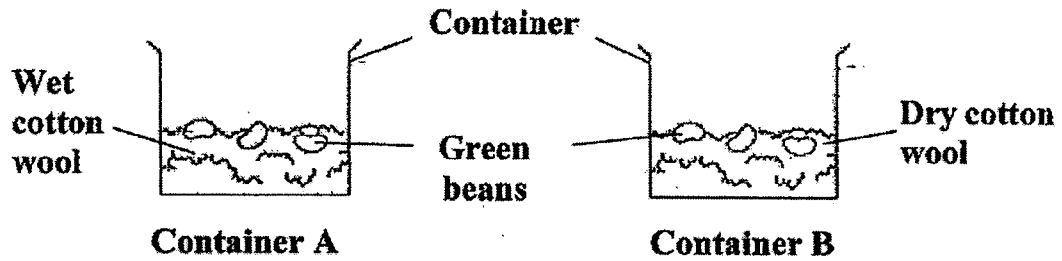

- (a) What will Leila observe about the green bean seeds in the two containers after five days? [1]

- (b) Explain your answer in (a). [2]

40. Megan wanted to find out what would happen to the drop of ink in set-up X when she placed the set-up in a basin of warm water.

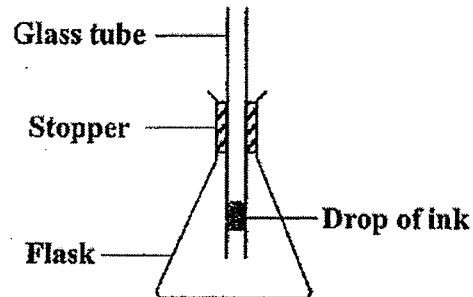

She then prepared another two set-ups, Y and Z, and placed both of them in two different basins of warm water at different temperatures. After a few minutes, she observed that the drop of ink in all three set-ups had moved up as shown below.

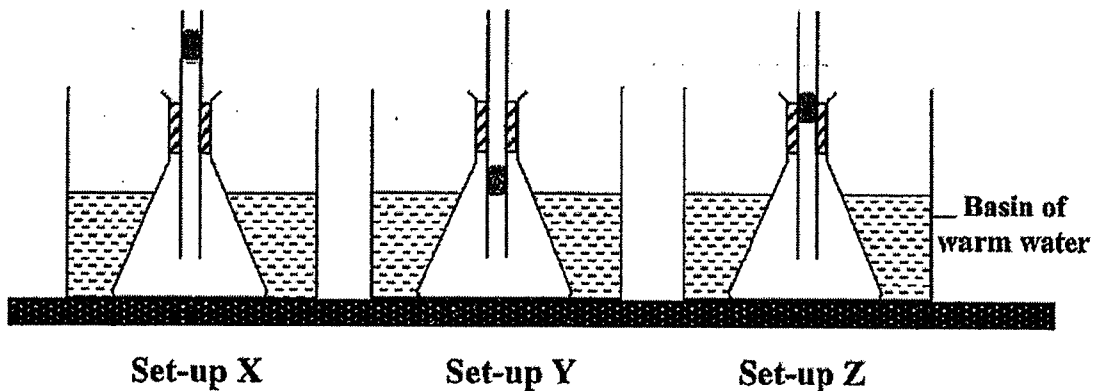

- (a) Based on the diagram above, fill in the table below with the correct set-up, X, Y or Z, that matches the temperature of the water in the basin. [1]

Temperature of the water in the basin ($^{\circ}\text{C}$)	Set-up
40	
50	
60	

- (b) Based on the results in the table above, explain why the drop of ink moved up in all the set-ups. [2]

41. Greg wanted to find out what would happen to the length of a bar when it is heated. He set up an experiment using three different bars, A, B and C, of similar shapes and sizes but made of different materials. Each bar was heated with the same amount of heat. He then recorded the results in the table below.

Bar	Length of bar before heating (cm)	Length of bar after heating (cm)
A	20	22
B	20	21
C	20	24

- (a) Based on the results in the table above, what can you conclude about the bars when they are heated? [1]

- (b) Name one variable that Greg should keep the same to make the experiment a fair test. [1]

Greg noticed gaps between the tiles on the ground at the car park as shown below.

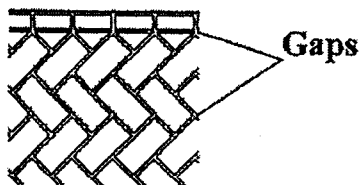

- (c) What is the purpose of having gaps in between the tiles? [2]

42. Jovan placed four similar pairs of leather shoes in four identical sealed boxes. He placed boxes A and B in an air-conditioned room and boxes C and D in a room at room temperature. Substance S which absorbs moisture from the surroundings was placed near the shoes in boxes B and D.

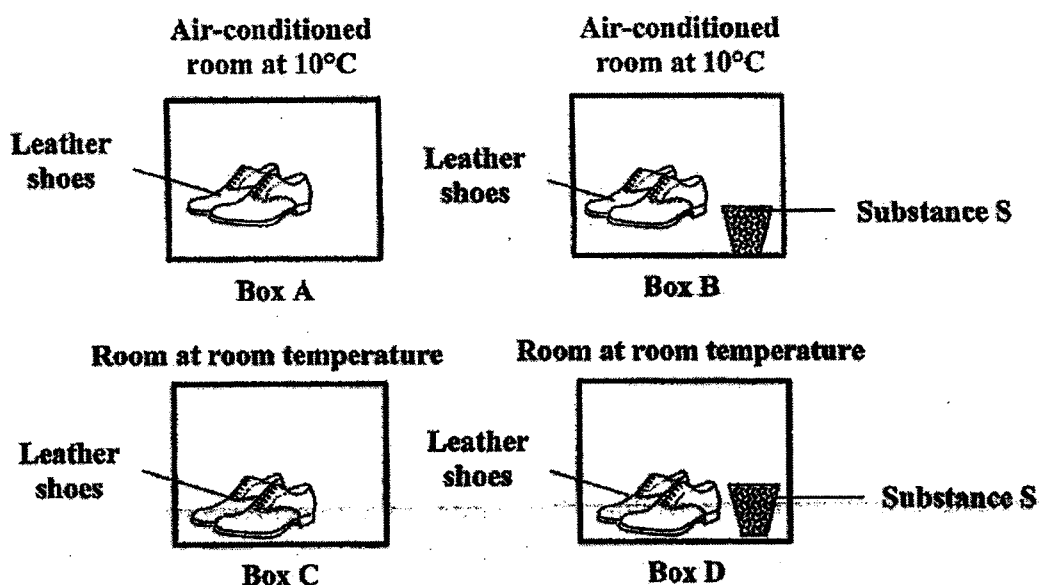

- (a) In which box, A, B, C or D, would mould first appear on the shoes? Explain your answer. [1]

- (b) In which group of living things does mould belong to? [1]

Anna kept her leather jacket in a dark and damp cupboard. She saw dark green spots growing on it when she took it out from the cupboard a month later.

Dark green spots (mould)

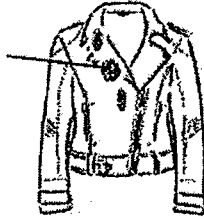

Anna's brother told her to place her jacket in the bright and airy living room to reduce the growth of mould on the jacket.

(c) Explain why his suggestion worked.

[1]

43. Zack moved a metal ball slowly from the 15cm mark along the ruler towards magnet P as shown in the diagram below. He recorded the distance, d cm, where the magnet started to attract the metal ball. He repeated the experiment using magnets Q, R and S.

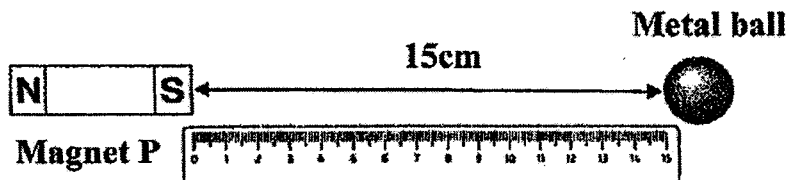

Zack recorded the results in the table below.

Magnet	Distance d (cm)
P	8
Q	10
R	5
S	7

- (a) Based on the results of his experiment, arrange the magnets, starting with the strongest, in the table below. [1]

Strongest → Weakest			

- (b) Why was the metal ball attracted to the magnet? [1]

- (c) Tick (✓) the variable(s) that Zack must keep the same to ensure a fair test in the table below. [1]

Variables	Tick (✓)
Magnet	
Metal ball	
Distance between the magnet and metal ball	

- (d) In another experiment, Zack dropped magnet Q several times before testing its strength again. Would magnet Q attract the metal ball from a distance of 10cm, more than 10cm or less than 10cm this time? Explain your answer. [1]
-
-

44. Kayley placed three blocks, X, Y and Z, made of different materials, in three similar beakers filled with 900cm^3 of water as shown in the diagram below. She left the beakers in her room overnight.

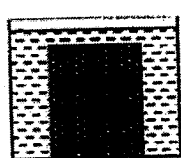

Block X

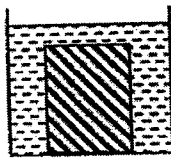

Block Y

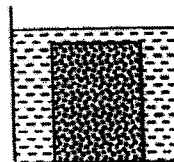

Block Z

Kayley recorded the results in the table below on the next day.

Block	Amount of water in beaker (cm^3)	Amount of water left in the beaker (cm^3)	Amount of water absorbed (cm^3)
X	900	800	100
Y	900	750	150
Z	900	900	0

- (a) Based on the results above, tick (\checkmark) the physical property of the blocks that Kayley was testing. [1]

Ability to float on /sink in water
 Strength

Flexibility
 Waterproof

- (b) The amount of water absorbed by block Z is 0cm^3 . What do the result say about block Z? [1]

- (c) Write down two variables that should be kept constant to make it a fair test. [2]

(i)

(ii)

END OF PAPER

SCHOOL : RULANG PRIMARY SCHOOL
 LEVEL : PRIMARY 4
 SUBJECT : SCIENCE
 TERM : 2022 SA2

SECTION A

Q 1	Q2	Q3	Q4	Q5	Q6	Q7	Q8	Q9	Q10
4	2	1	3	2	4	4	3	4	2
Q 11	Q12	Q13	Q14	Q15	Q16	Q17	Q18	Q19	Q20
4	3	4	2	4	2	2	1	3	4
Q 21	Q22	Q23	Q24	Q25	Q26	Q27	Q28	Q29	Q30
4	2	1	4	2	3	2	1	3	2

SECTION B

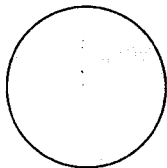
Q31)	a) Liquid b) Solid
Q32)	a) A b) D
Q33)	The wax on the metal rod melted <u>faster</u> than the wax on the plastic rod, as metal is a <u>better</u> conductor of heat than plastic.
Q34)	a) Decrease b) Air
Q35)	a) blocked b) 
Q36)	a) No. A shadow is formed when there is an object blocking the path of light. Therefore, a shadow cannot be formed when there is no light. b) The torchlight was directly above the block of wood.

	c) The length of the shadow increased as the torchlight moved from positions B to C.
Q37)	a) The more leaves there are on the plant, the more water is absorbed. b) Plant X will wilt as it does not have roots and cannot absorb water and minerals from the soil while plant Y will not wilt as it has roots so it can absorb water and minerals from the soil.
Q38)	a) P , S , T b) The organ is called the large intestine, Its main function is to absorb water and minerals from the undigested food.
Q39)	a) The seeds in container A will germinate while the seeds in container B will not germinate. b) The seeds in container A have water but the seeds in container B do not have water.
Q40)	a) Y Z X b) The air in the flask gained heat from the hot water and expanded in the glass tube and pushed the drop of ink.
Q41)	a) The bars gained heat and expanded after heating. b) He should heat each bar for the same amount of time. c) On hot days, the tiles would gain heat and expand. Therefore, the gaps are to prevent the tiles from buckling with each other.
Q42)	a) Box C. Mould grows when there is moisture and warmth. b) Fungi c) Mould can only thrive in dark and moist places. So, without moisture, the mould could not thrive anymore.
Q43)	a) <input type="checkbox"/> Q <input type="checkbox"/> P <input type="checkbox"/> S <input type="checkbox"/> R b) The metal ball is made of a magnetic material. c) Metal ball <input checked="" type="checkbox"/> d) H would be less than 10cm as the magnetism has been weakened.
Q44)	a) <input checked="" type="checkbox"/> waterproof b) Block Z is waterproof as it did not absorb any water. c) i) Duration of experiment ii) The size of the block.