



Rosyth School
End-of-Year Examination 2021
Mathematics
Paper 1
Primary 5

Name: _____

Register No. _____

Class: Pr 5 - _____ Group: _____

Date: 28 October 2021

Parent's Signature: _____

Total Time for Booklets A and B : 1 hour

Booklet A

Instructions to Pupils:

1. Do not open this booklet until you are told to do so.
2. Follow all instructions carefully.
3. Shade your answers in the Optical Answer Sheet (OAS) provided.
4. You are not allowed to use a calculator.
5. Answer all questions.

Section	Maximum Mark	Marks Obtained
Paper 1 (Booklet A)	20	

* This booklet consists of 7 pages (including this cover page).

This paper is not to be reproduced in part or whole without the permission of the Principal.

Questions 1 to 10 carry 1 mark each. Questions 11 to 15 carry 2 marks each.
For each question, four options are given. One of them is the correct answer.
Make your choice (1, 2, 3 or 4). Shade the oval (1, 2, 3 or 4) on the Optical Answer Sheet.

All diagrams in this paper are not drawn to scale unless stated otherwise.

(20 marks)

1. Round off 348 550 to the nearest thousand.

- (1) 348 000
- (2) 348 600
- (3) 349 000
- (4) 350 000

2. In 35 416, what does the digit 5 stand for?

- (1) 5 ones
- (2) 5 tens
- (3) 5 hundreds
- (4) 5 thousands

3. How many eighths are there in $2\frac{3}{4}$?

- (1) 6
- (2) 9
- (3) 11
- (4) 22

(Go on to the next page)

4. What is the value of the digit 7 in 26.475?
- (1) 0.007
 - (2) 0.07
 - (3) 0.7
 - (4) 7
5. There are 72 books on a shelf. 45 of them are storybooks while the rest are comic books. What is the ratio of the number of comic books to the number of storybooks on the shelf?
- (1) 3 : 5
 - (2) 5 : 3
 - (3) 5 : 8
 - (4) 8 : 5
6. Toby had \$200. He gave \$70 to his mother. What percentage of his money did Toby give to his mother?
- (1) 30%
 - (2) 35%
 - (3) 65%
 - (4) 70%

(Go on to the next page)

7. The figure shows a cuboid with a square base of side 3 cm and a height of 8 cm. What is the volume of the cuboid?

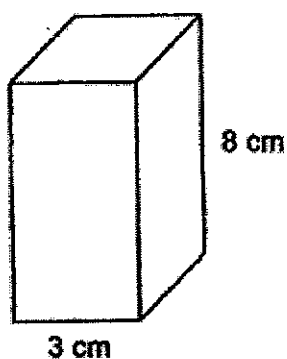

- (1) 24 cm^3
 (2) 48 cm^3
 (3) 72 cm^3
 (4) 192 cm^3
8. The table below shows the marks Gary scored for four subjects.

Subject	Marks
English	72
Mathematics	?
Mother Tongue	68
Science	70

Gary scored a total of 268 marks for his four subjects. How many marks did he score for Mathematics?

- (1) 56
 (2) 58
 (3) 60
 (4) 62

(Go on to the next page)

9. In the figure below, PR and ST are straight lines. Find $\angle UOT$.

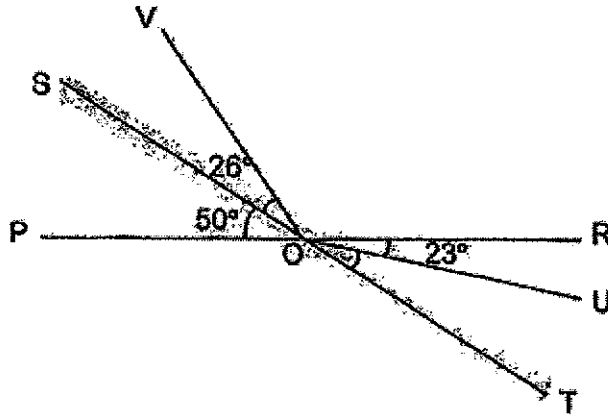

- (1) 23°
 (2) 26°
 (3) 27°
 (4) 53°
10. In the figure below, ABC is an isosceles triangle. BCE is a straight line. Find $\angle ACD$.

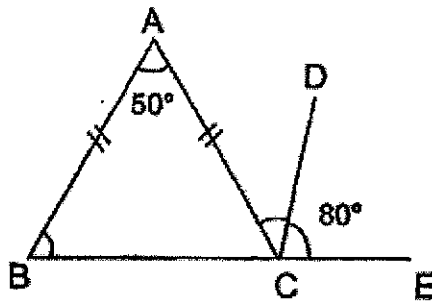

- (1) 35°
 (2) 40°
 (3) 50°
 (4) 65°

(Go on to the next page)

11. The thickness of one magazine is 0.35 m. What is the thickness of 8 similar magazines in metres and centimetres?
- (1) 2 m 8 cm
 - (2) 2 m 80 cm
 - (3) 20 m 8 cm
 - (4) 20 m 80 cm
12. Sue has some \$2 and \$5 notes. The number of \$2 notes is twice the number of \$5 notes. The total value of all the notes is \$126. How many \$2 notes does she have?
- (1) 14
 - (2) 18
 - (3) 28
 - (4) 36
13. Andy bought 5 kg of flour. He used $\frac{1}{10}$ of the flour to bake cookies. How much flour did Andy have left?
- (1) $\frac{9}{10}$ kg
 - (2) $4\frac{1}{2}$ kg
 - (3) $4\frac{9}{10}$ kg
 - (4) $5\frac{1}{10}$ kg

(Go on to the next page)

14. Mr Leon had \$245. He gave $\frac{1}{7}$ of his money to his mother and gave the remaining amount of money to his three brothers equally. How much money did each brother receive?

- (1) \$35
 (2) \$70
 (3) \$105
 (4) \$210

15. The figure below is formed using 5 equilateral triangles. The length of XY is 21 cm. Find the perimeter of the figure.

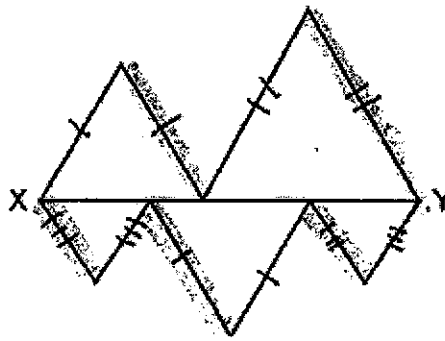

- (1) 84 cm
 (2) 105 cm
 (3) 126 cm
 (4) 210 cm

(End of Booklet A)



Rosyth School
End-of-Year Examination 2021
Mathematics
Paper 1
Primary 5

Name: _____

Register No. _____

Class: Pr 5 - _____

Group No. _____

Date: 28 October 2021

Parent's Signature: _____

Total Time for Booklets A and B : 1 hour

Booklet B

Instructions to Pupils:

1. Do not open this booklet until you are told to do so.
2. Follow all instructions carefully.
3. You are not allowed to use a calculator.
4. Write your answers in the booklet.
5. Answer all questions.

Section	Maximum Mark	Marks Obtained
Paper 1 (Booklet B)	25	

* This booklet consists of 9 pages (including this cover page).

This paper is not to be reproduced in part or whole without the permission of the Principal.

Questions 16 to 20 carry 1 mark each. Write your answers in the spaces provided.
For questions which require units, give your answers in the units stated.

Do not write
in this space

All diagrams in this paper are not drawn to scale unless stated otherwise.
(5 marks)

16. Find the value of $6 + 3 \times (14 - 6) \div 2$.

Ans : _____

17. Find the value of $\frac{2}{3} + \frac{5}{6}$. Give your answer as a mixed number in the simplest form.

Ans : _____

18. Find the value of $64.8 \div 80$.

Ans : _____

19. Complete the following figure to make it symmetrical using line XY as the line of symmetry.

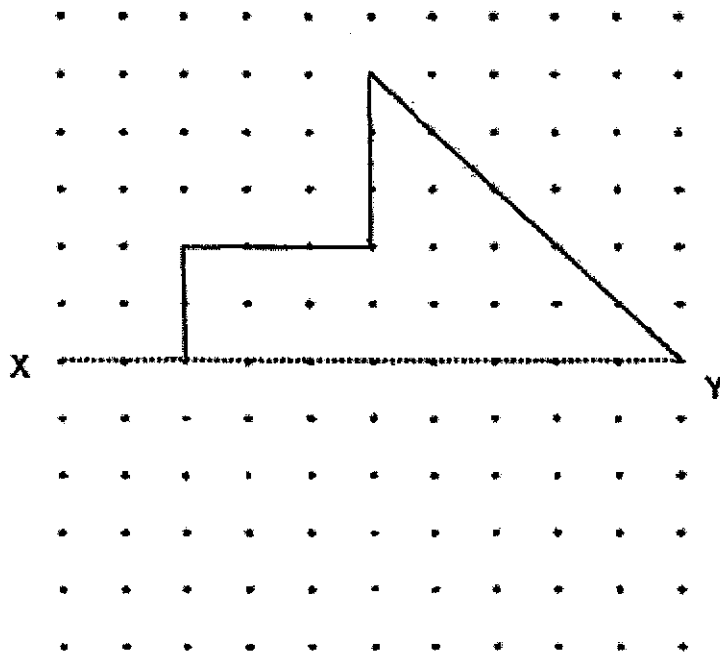

Do not write in this space

20. In the diagram below, the angles meet at a point. Find $\angle a$.

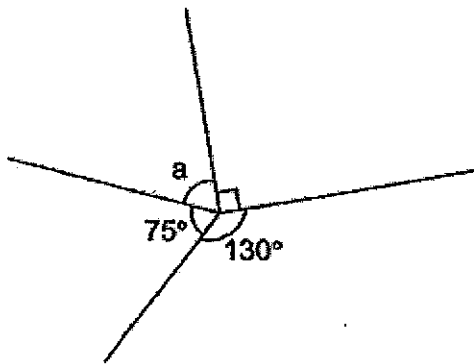

Ans : _____ °

Questions 21 to 30 carry 2 marks each. Show your workings clearly in the space provided for each question and write your answers in the spaces provided. Do not write in this space. For questions which require units, give your answers in the units stated.

All diagrams in this paper are not drawn to scale unless stated otherwise.
(20 marks)

21. Mrs Rajah deposits \$15 000 in a bank for one year. The interest rate is 2% per year. What is the total amount of money she will have in the bank at the end of one year?

Ans : \$ _____

22. In the figure below, CAD is a straight line. Find the area of triangle ABC .

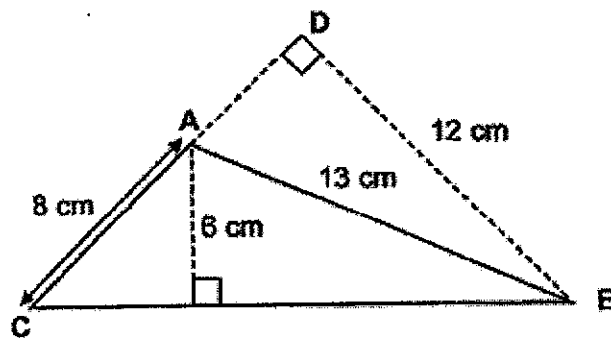

Ans : _____ cm^2

23. The line graph below shows the amount of money Helena spent from January to April.

Do not write
in this space

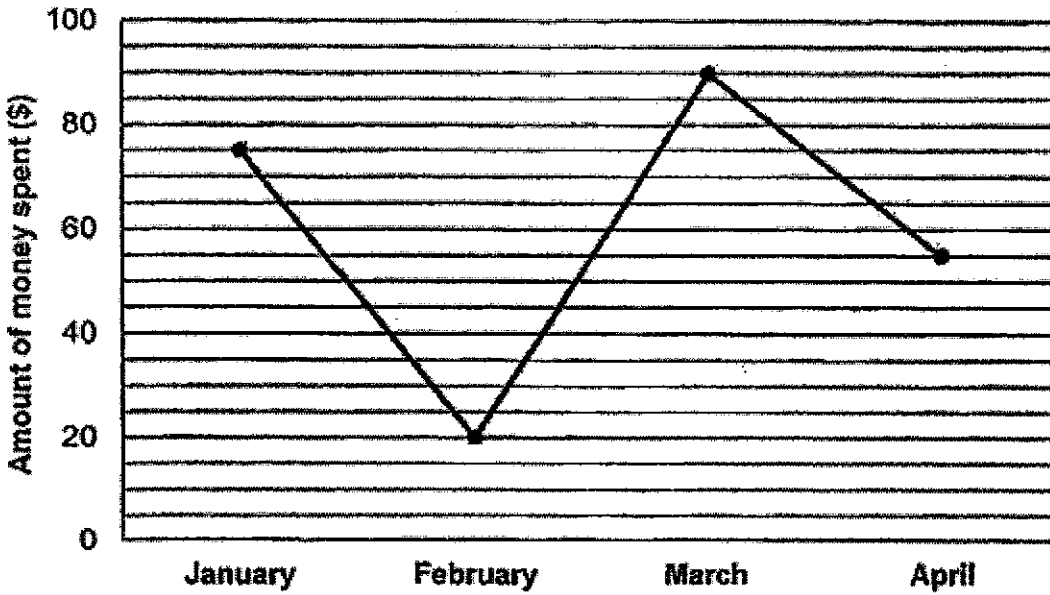

What was the total amount of money that Helena spent from January to April?

Ans : \$ _____

24. Using line AB shown below, draw and label Triangle ABC where $AB = BC$.

Do not write in this space

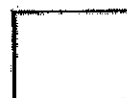
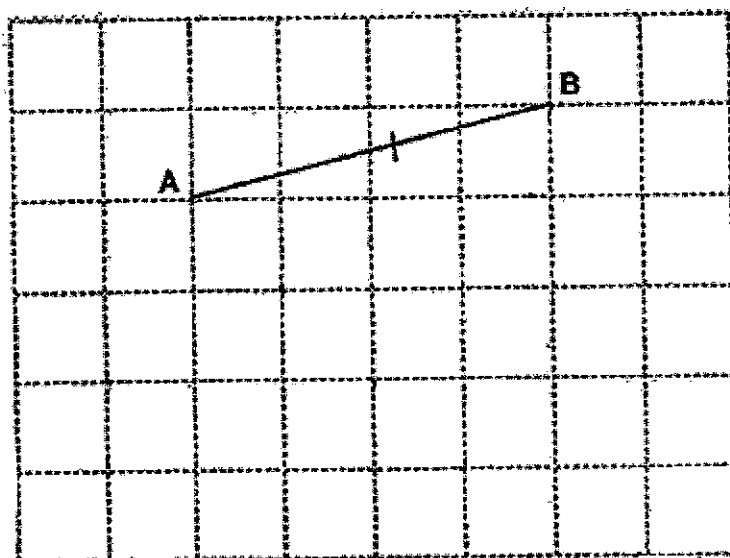

25. In the figure below, ABCD is a square. $AE = CE$ and $\angle AEC$ is 34° . Find $\angle DAE$.

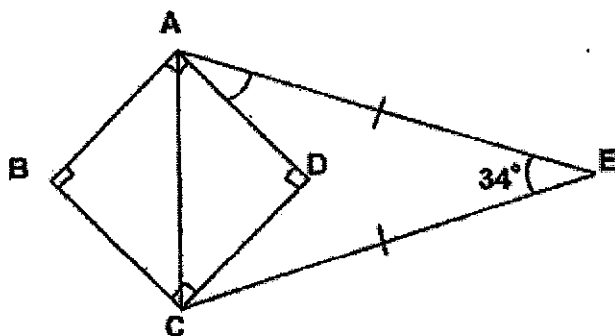

Ans : _____ °



26. 6 girls and 4 boys shared some stickers equally among themselves. When each of the 6 girls gave up half of their share, the boys had 3 extra stickers each. How many stickers were there altogether?

Do not write
in this space

Ans : _____

27. Penny spent \$16.50 on 3 similar books and 2 similar files. Each book cost \$3 more than each file. How much did each book cost?

Ans : \$ _____

28. There are three types of straws in a box. The ratio of the number of red straws to the number of blue straws is 4 : 5. The ratio of the number of green straws to the total number of red and blue straws is $\frac{5}{11}$. Given that there are 32 red straws, find the number of green straws in the box.

Do not write
in this space

Ans : _____

29. A rectangular container measuring 40 cm by 20 cm by 10 cm is $\frac{3}{5}$ filled with water at first. $\frac{1}{2}$ of the water is poured out of the container. Find the volume of water left in the container.

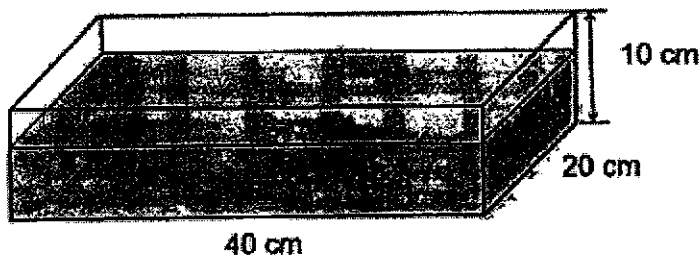

Ans : _____ cm³

30. Ben folded a rectangular piece of paper ABCD along its diagonal AC. Find $\angle ACD$.

Do not write in this space

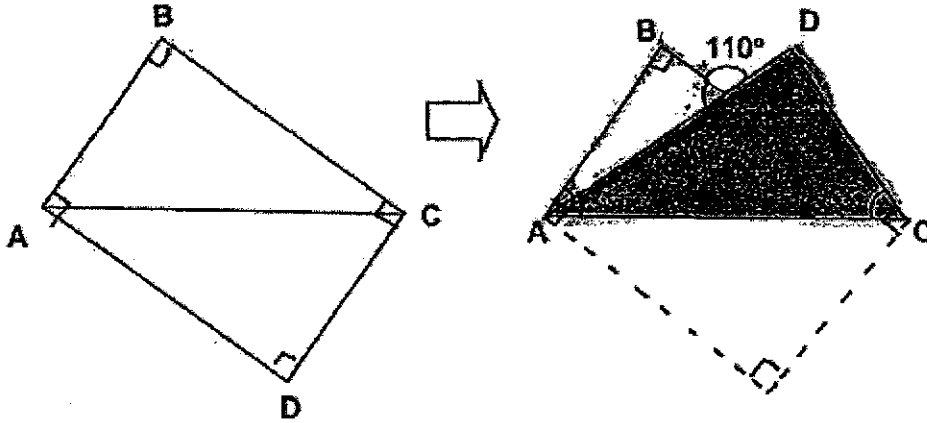

Ans : _____ °



End of Paper
Have you checked your work?



Rosyth School
End-of-Year Examination 2021
Mathematics Paper 2
Primary 5

Name: _____

Register No. _____

Class: Pr 5 - _____

Group No. _____

Date: 28 October 2021

Parent's Signature: _____

Time: 1 h 30 min

PAPER 2

Instructions to Pupils:

1. Do not open this booklet until you are told to do so.
2. Follow all instructions carefully.
3. **Show your workings clearly** as marks are awarded for correct working.
4. Write your answers in this booklet.
5. You are allowed to use a calculator.
6. Answer all questions.

Questions	Maximum Mark	Marks Obtained
Q 1 to 5	10	
Q 6 to 17	45	

Section	Maximum Mark	Marks Obtained
Paper 1	45	
Paper 2	55	
Total	100	

* This booklet consists of 14 pages (including this cover page)

This paper is not to be reproduced in part or whole without the permission of the Principal.

Questions 1 to 5 carry 2 marks each. Show your working clearly in the space provided for each question and write your answers in the spaces provided. For questions which require units, give your answers in the units stated.

Do not write in this space

(10 marks)

All diagrams in this paper are not drawn to scale unless stated otherwise.

1. The solid figure below is made up of 6 cubes.

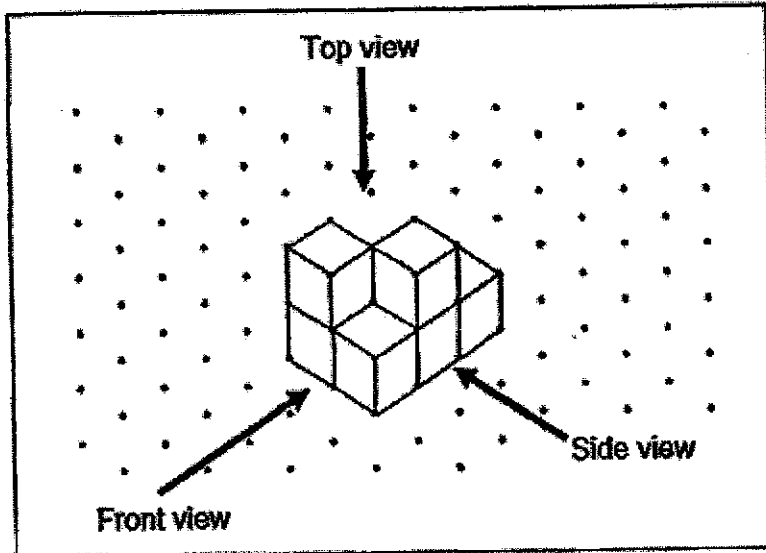

- (a) Draw the top view of the solid figure.
- (b) Draw the side view of the solid figure.

(a) Top View:

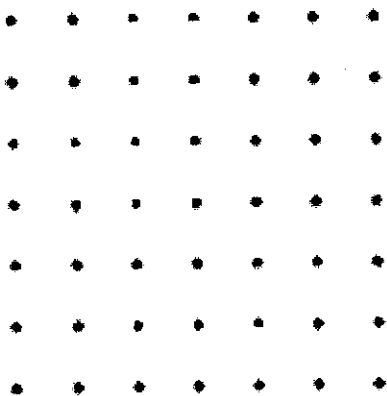

(b) Side View:

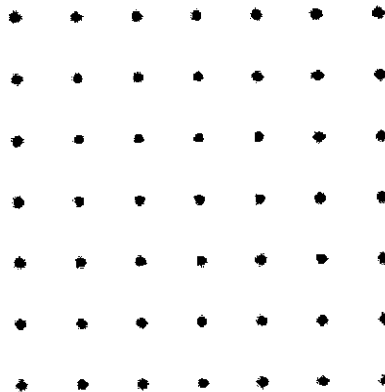

2. John and Ken scored an average of 65 marks for their tests. John scored 14 marks more than Ken. How many marks did Ken score for his test?

Do not write
in this space

Ans: _____

3. The table below shows the parking charges at a car park.

First hour	\$2
Every additional $\frac{1}{2}$ hour or part thereof	\$0.90

Mr Goh parked his car at the car park for 135 min. How much did he pay for the parking charges?

Ans: \$ _____

4. In the figure below, BCD is an equilateral triangle and ABC is an isosceles triangle. AD is a straight line. Find $\angle ACB$.

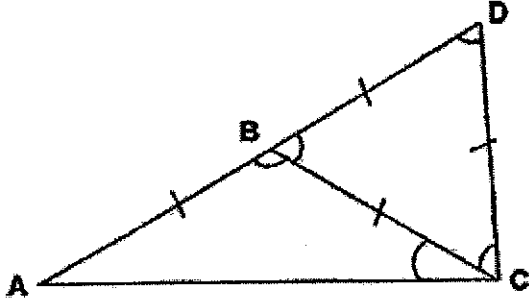

Do not write
in this space

Ans: _____ °

5. Sean wanted to pack 48 apples and 72 oranges into as many bags as possible with no remainder. He packed the same number of fruit in each bag. The number of oranges in each bag was the same. How many oranges were there in each bag?

Ans: _____

For Questions 6 to 17, show your working clearly in the space provided for each question and write your answers in the spaces provided. The number of marks available is shown in brackets [] at the end of each question or part-question. For questions which require units, give your answers in the units stated. (45 marks)

Do not write
in this space

All diagrams in this paper are not drawn to scale unless stated otherwise.

6. At first, Amir had \$450 and Rickesh had \$265. Each of them bought a tennis racket at the same price. The ratio of the amount of money Amir had left to the amount of money Rickesh had left became 7 : 3. How much did the tennis racket cost?

Ans: _____ [3]

7. The figure below shows two squares, with sides 3 cm and 10 cm, and a shaded triangle. Find the total area of the unshaded parts.

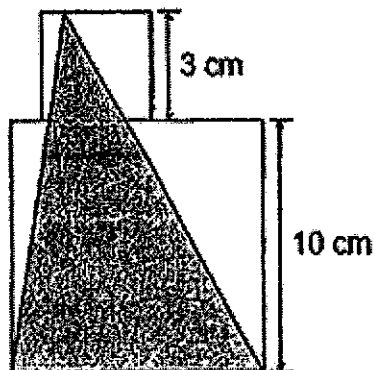

Ans: _____ [3]

8. In the figure below, BCD is an isosceles triangle and $\angle BDA = 78^\circ$. Find $\angle DAE$.

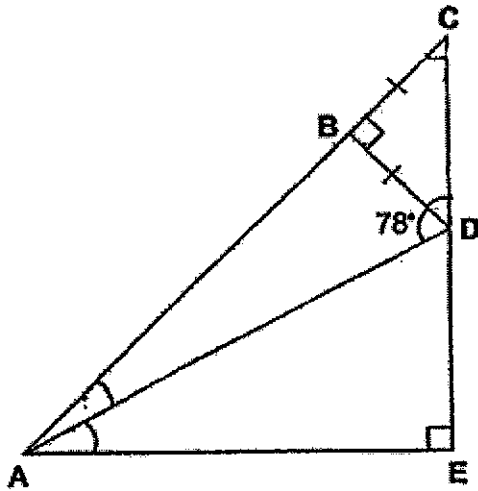

Do not write
in this space

Ans: _____ [3]

9. Tim spent $\frac{1}{10}$ of his money on a cap and $\frac{2}{3}$ of his remaining money on a pair of shoes. He had \$66 left. How much money did Tim have at first?

Ans: _____ [3]

10. The figure below is made up of four small squares. Linda had painted part of one square white and the rest of the figure grey. The perimeter of the white part is 38 cm and the perimeter of the grey part is 72 cm. Find the area of one small square.

Do not write
in this space

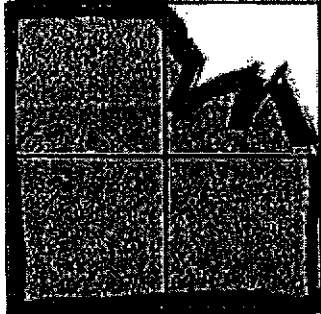

Ans: _____ [3]



11. Container A and B held a total of 10.25 t of water. After 2.75 t of water was transferred from Container A to Container B, Container B had 4 times as much water as Container A. How much water was in Container B at first?

Do not write
in this space

Ans: _____ [4]

12. The graph below shows the cost of printing invitation cards for the first 200 cards.

Do not write in this space

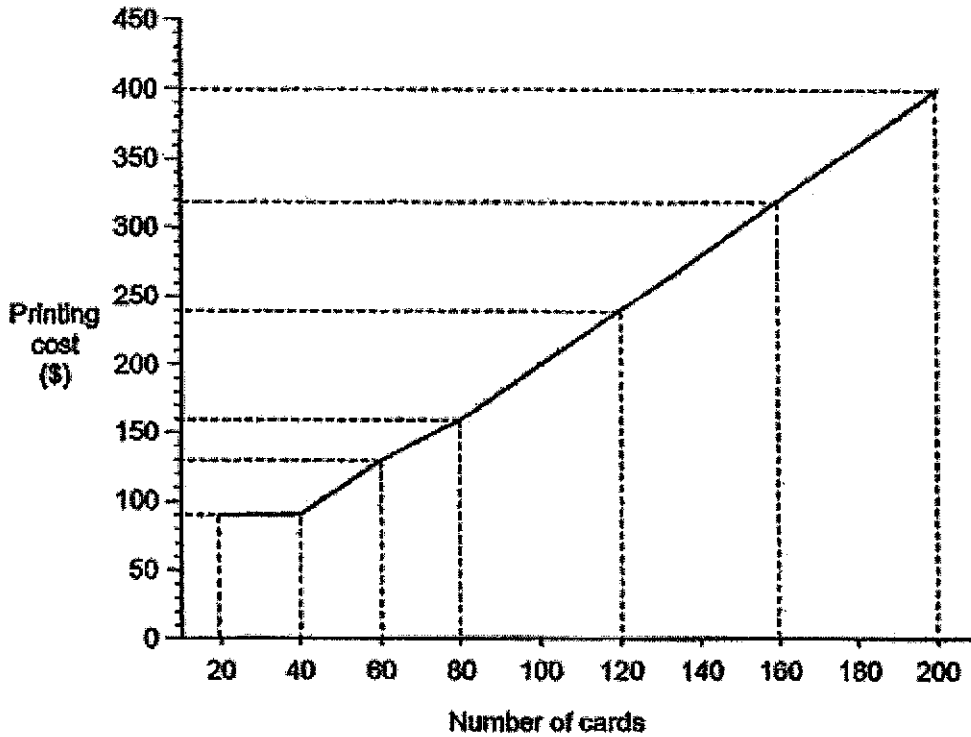

- (a) Wendy printed 40 invitation cards. How much did she have to pay?
- (b) Xavier paid \$130 for his invitation cards. How many invitation cards did he print?
- (c) How much does the printing company charge for every invitation card printed after the 80th invitation card?

Ans: (a) _____ [1]

(b) _____ [1]

(c) _____ [2]



13. During a sale, Mdm Hasnah bought a blouse and a skirt at a discount. She paid a total of \$189.10 on these two items. She paid \$52.30 more on the blouse than on the skirt.

Do not write
in this space

- (a) How much did she pay for the blouse?
- (b) Mdm Hasnah received a total discount of \$38.40 for the blouse and the skirt. What is the percentage discount given by the shop? Give your answer correct to 1 decimal place.

Ans: (a) _____ [2]

(b) _____ [2]

14. Mrs Tan had two rolls of ribbons of the same length but different designs. She cut the first roll of ribbon into equal pieces of length 40 cm and there were 7 suns on each piece of ribbon as shown below.

Do not write
in this space

First roll of ribbon

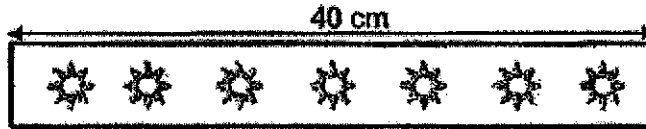

She then cut the second roll of ribbon into equal pieces of length 60 cm and there were 9 stars on each piece of ribbon as shown below.

Second roll of ribbon



After she finished cutting both rolls of ribbons, she counted that the total number of suns was 126 more than the total number of stars. Find the length of one roll of ribbon.

Ans: _____ [4]



15. The bar graph below shows the number of people who went for a theatre play from Tuesday to Friday last week. The theatre can hold a maximum number of 600 people for each day.

Do not write
in this space

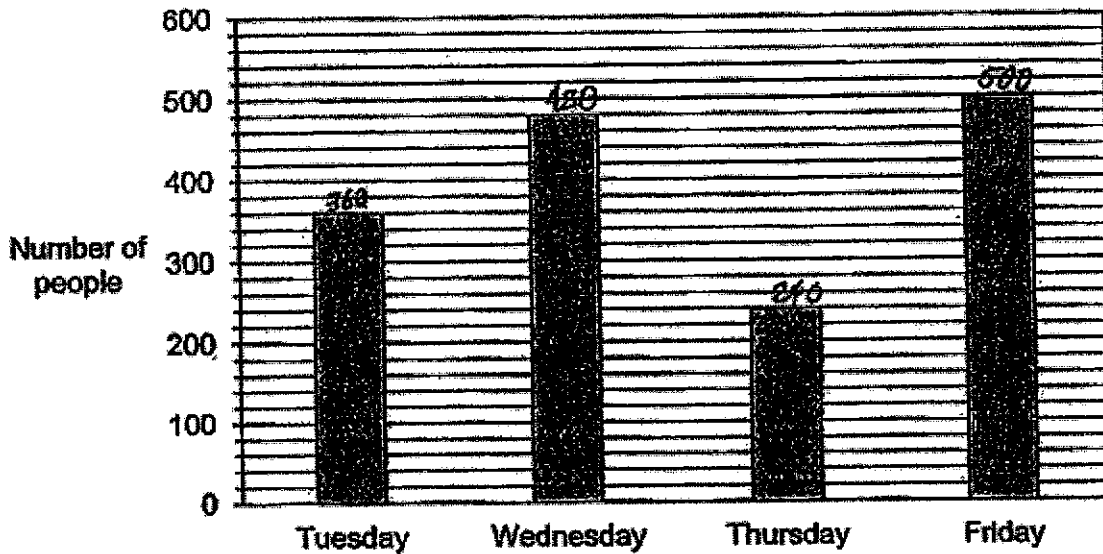

- (a) What was the average number of people from Tuesday to Friday last week?
- (b) The average number of people on Saturday and Sunday was 85 more than the average number of people from Tuesday to Friday.

Write down one possible set of values for the number of people on Saturday and Sunday.

Ans: (a) _____ [2]

(b) _____ [2]

16. Rani packed some candles into two boxes of different sizes. The small box can hold 100 candles while the big box can hold 240 candles. She packed half of the number of candles in small boxes and the other half of the number of candles in big boxes. At the end of her packing, Rani counted that there were 21 more small boxes than big boxes.

Do not write
in this space

- (a) How many small boxes of candles did Rani pack?
(b) How many candles were there altogether?

Ans: (a) _____ [3]

(b) _____ [2]

17. Marsya spent $\frac{2}{5}$ of her money on 8 rulers and 12 pens. The cost of one pen is twice the cost of one ruler. She bought some more pens with $\frac{1}{4}$ of her remaining money. How many pens did Marsya buy altogether?

Do not write
in this space

Ans: _____ [5]

End of paper
Have you checked your work?

SCHOOL : ROSYTH PRIMARY SCHOOL
 LEVEL : PRIMARY 5
 SUBJECT : MATH
 TERM : 2021 EOY

PAPER 1 BOOKLET A

Q 1	Q2	Q3	Q4	Q5	Q6	Q7	Q8	Q9	Q10
3	4	4	2	1	2	3	3	3	1

Q 11	Q12	Q13	Q14	Q15
2	3	2	2	1

PAPER 1 BOOKLET B

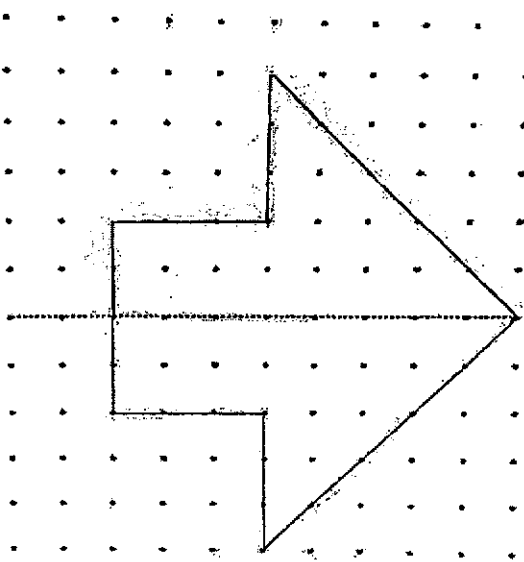
Q16)	18
Q17)	$1\frac{1}{2}$
Q18)	0.81
Q19)	
Q20)	65°
Q21)	<p>100% → 15000</p> <p>1% → $15000 \div 100 = 150$</p> <p>102% → $150 \times 102 = 15300$</p>

	<p>Ans: \$15300</p>
Q22)	<p>$8 \times \frac{1}{2} \times 8 = 48$ Ans: 48cm^2</p>
Q23)	<p>Total $\rightarrow 75 + 20 + 90 + 55 = 240$ Ans: \$240</p>
Q24)	
Q25)	<p>Angle CAD: $90 \div 2 = 45$ Angle CAE: $(180 - 34) \div 2 = 73$ Angle DAE: $73 - 45 = 28$ Ans: 28°</p>
Q26)	<p>$\frac{1}{2}$ girls: $3 \times 4 = 12$ 6 girls: $12 \times 2 = 24$ 1 girl: $24 \div 6 = 4$ 4 boys: $4 \times 4 = 16$ Total: $16 + 24 = 40$ Ans: 40 stickers</p>
Q27)	<p>3B</p> <p>2F</p> <p>5u: $16.50 + 3 \times 2 = 22.50$ 1u: $22.50 \div 5 = 4.50$ Ans: \$4.50</p>
Q28)	<p>R : B : G 4 : 5 6 : 5 8 : 10 : 15</p> <p>R: 32 8u : 32 1u: $32 \div 8 = 4$ G: $15 \times 4 = 60$</p>

	Ans: 60 green straws
Q29)	Vol at first: $(10 \div 5 \times 3) \times 20 \times 40 = 4800$ Left: $4800 \div 2 = 2400$ Ans: 2400cm^2
Q30)	$180 - 110 = 70$ Angle BAD: $180 - 90 - 70 = 20$ Angle DAC: $70 \div 2 = 35$ Angle ACD: $180 - 35 - 90 = 55$ Ans: 55°

PAPER 2

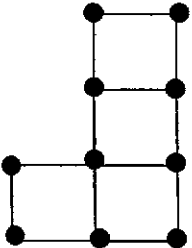
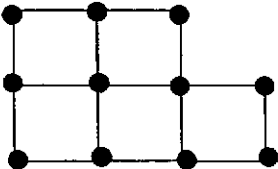
Q1)	<p>a)</p>  <p>b)</p> 
Q2)	Total: $65 \times 2 = 130$ 2u: $130 - 14 = 116$ K: $116 \div 2 = 58$ Ans: 58 marks
Q3)	$135\text{min} = 2\text{h } 15\text{min}$ Extra = 1h 15min 1h 15min \rightarrow 3 sets 3 sets $\rightarrow 0.90 \times 3$ $= 2.70$ Total $\rightarrow 2.70 + 2$ $= 4.70$ He paid \$4.70.
Q4)	Angle ABC $\rightarrow 180 - 160$ $= 120$ Angle ACB $\rightarrow (180 - 120) \div 2$ $= 30$ Angle ACB is 30° .
Q5)	

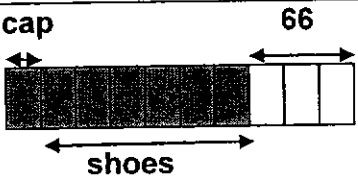
	$\begin{array}{r} \underline{48} \\ 1 \times 48 \\ 2 \times 24 \\ 3 \times 16 \\ 4 \times 12 \\ 6 \times 8 \end{array}$ $\begin{array}{r} \underline{72} \\ 1 \times 72 \\ 2 \times 36 \\ 3 \times 24 \\ 4 \times 18 \\ 8 \times 9 \end{array}$ <p>Largest common $\rightarrow 24$ No. of oranges $\rightarrow 72 \div 24$ $= 3$ There were 3 oranges.</p>
Q6)	$u \text{ diff} \rightarrow 7 - 3$ $= 4$ $4u \rightarrow 450 - 265$ $= 185$ $1u \rightarrow 185 \div 4$ $= 46.25$ $3u \rightarrow 46.25 \times 3$ $= 138.75$ $TR \rightarrow 265 - 138.75$ $= 126.25$ <p>It costs \$126.25.</p>
Q7)	$\text{Big length} \rightarrow 10 + 3$ $= 13$ $\text{Shaded} \rightarrow 10 \times 13 \times \frac{1}{2}$ $= 65$ $\text{Total} \rightarrow 3 \times 3 + 10 \times 10$ $= 109$ $\text{Unshaded} \rightarrow 109 - 65$ $= 44$ <p>The area is 44cm^2.</p>
Q8)	$\text{Angle ACE} \rightarrow (180 - 90) \div 2$ $= 45$ $\text{Angle ADE} \rightarrow 180 - 78 - 45$ $= 57$ $\text{Angle DAE} \rightarrow 180 - 90 - 57$ $= 33^\circ$
Q9)	 <p>$\frac{2}{3} = \frac{6}{9}$</p> $1u \rightarrow 66 \div 3$ $= 22$ $10u \rightarrow 22 \times 10$

	$= 220$ Tim had \$220.
Q10)	$4L \rightarrow 72 - 38$ $= 34$ $1L \rightarrow 34 \div 4$ $= 8.5$ $1 \text{ sq} \rightarrow 8.5 \times 8.5$ $= 72.25$ The area is 72.25cm².
Q11)	$5u \rightarrow 10.25$ $1u \rightarrow 10.25 \div 5$ $= 2.05$ $4u \rightarrow 2.05 \times 4$ $= 8.2$ B at first $\rightarrow 8.2 - 2.75$ $= 5.45$ Container B had 5.45ℓ of water.
Q12)	a) 40 cards \rightarrow \$90 She paid \$90 b) \$130 \rightarrow 60 cards He printed 60 invitation cards c) each $\rightarrow 200 \div 100$ $= 2$ They charge \$2
Q13)	a) $2u \rightarrow 189.10 + 52.30$ $= 241.40$ $1u \rightarrow 241.40 \div 2$ $= 120.70$ She paid \$120.70 b) Total without discount $\rightarrow 189.10 + 38.40$ $= 227.50$ % discount $\rightarrow \frac{38.40}{227.50} \times 100$ $= 16.9$ They gave 16.9% discount.
Q14)	Common multiple $\rightarrow 120$ Sun 120cm $\rightarrow 7 \times 3$ $= 21$

	<p>Stars $120\text{cm} \rightarrow 9 \times 2$ $= 18$</p> <p>1 set diff $\rightarrow 21 - 18$ $= 3$</p> <p>No. of sets $\rightarrow 126 \div 3$ $= 42$</p> <p>One roll $\rightarrow 42 \times 120$ $= 5040$</p> <p>The length is 5040cm.</p>
Q15)	<p>a)</p> <p>Total $\rightarrow 360 + 480 + 240 + 500$ $= 1580$</p> <p>Average $\rightarrow 1580 \div 4$ $= 395$</p> <p>The average is 395 people.</p> <p>b)</p> <p>Sat and Sun average $\rightarrow 395 + 85$ $= 480$</p> <p>Sat and Sun total $\rightarrow 480 \times 2$ $= 960$</p> <p>Possible $\rightarrow 492$ and 468</p> <p>There might be 468 people and 492 people.</p>
Q16)	<p>a)</p> <p>$15 \times 240 = 3600$</p> <p>$15 + 21 = 36$</p> <p>$36 \times 100 = 3600$</p> <p>Small box $\rightarrow 36$</p> <p>She packed 36 small boxes.</p> <p>b)</p> <p>Total $\rightarrow 3600 \times 2$ $= 7200$</p> <p>There were 7200 candles.</p>
Q17)	<p>1</p> <p>$\frac{2}{5}$ (8 rulers, 12 pens)</p> <p>$\frac{1}{4}$ (more P)</p> <p>$\frac{3}{4}$ (remain)</p> <p>$\frac{3}{4}$ (left)</p> <p>$8R = 8u$</p> <p>$12P = 12 \times 2$ $= 24u$</p>

$$\frac{2}{5} \text{ of total} \rightarrow 8 + 29 \\ = 32u$$

$$\frac{1}{5} \text{ of total} \rightarrow 32 \div 2 \\ = 16u$$

$$\frac{3}{5} \text{ of total} \rightarrow 16 \times 3 \\ = 48$$

$$\text{More P} \rightarrow \frac{1}{4} \times 48 \\ = 12$$

$$\text{No. of new P} \rightarrow 12 \div 2 \\ = 6$$

$$\text{Total P} \rightarrow 6 + 12 \\ = 18$$

She bought 18 pens.

