

SA2



RAFFLES GIRLS' PRIMARY SCHOOL

PRELIMINARY EXAMINATION
2021

Section A	56
Section B	44
Your score out of 100%	
Parent's signature	

Name : _____

Index No.: _____

Class: P6 _____

20 AUG 2021

SCIENCE

Duration: 1 h 45 min

SECTION A (28 x 2 marks)

For each question from 1 to 28, four options are given. One of them is the correct answer. Make your choice (1, 2, 3 or 4). Shade the correct oval (1, 2, 3 or 4) on the Optical Answer Sheet (OAS) provided.

- 1 Sam spotted a staghorn fern and mushrooms, as shown in the diagram below.



Staghorn fern



Mushrooms

Which of the following is correct about both the staghorn fern and the mushrooms?

- A Both reproduce from spores.
 B Both are non-flowering plants.
 C Both can make their own food.

- (1) A only
 (2) C only
 (3) A and B only
 (4) B and C only

2 Sarah bought a toy doll that came with a feeding bottle as shown below.



She fed the toy doll daily and recorded the height of the doll weekly. Which of the following graphs correctly shows the results over four weeks?

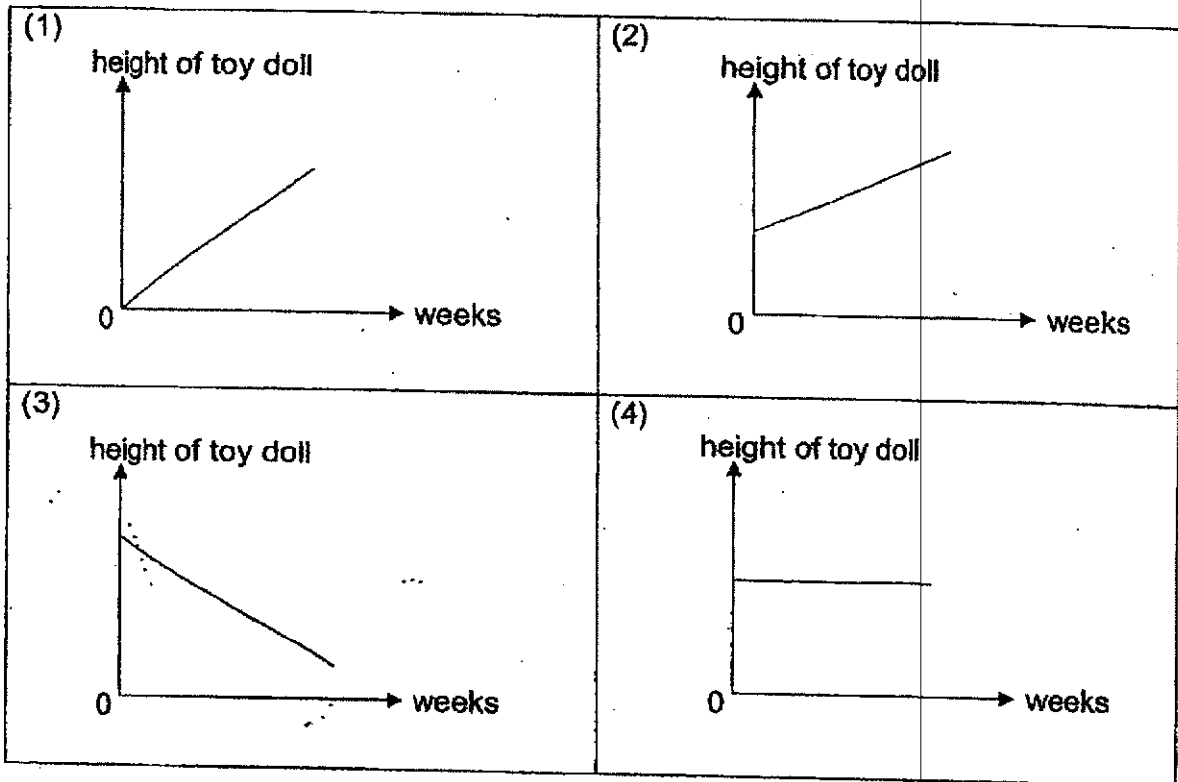

- 3 The diagram below shows the development of a plant at different stages namely A, B and C:

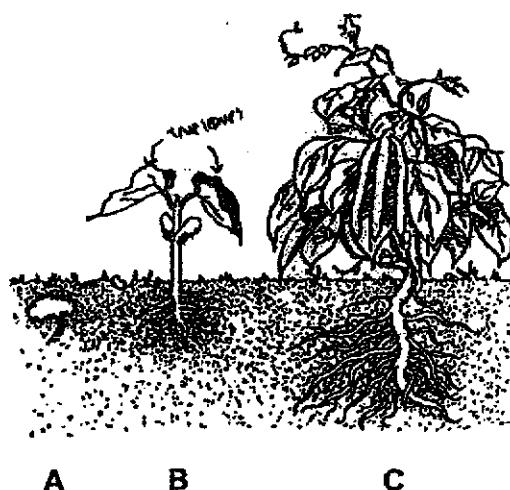

At which stage(s) do/does the seedling **only** depend on its seed leaves for food?

- (1) A only
 (2) A and B only
 (3) B and C only
 (4) A, B and C
- 4 The graph below shows the changes in food intake by an insect throughout its life cycle.

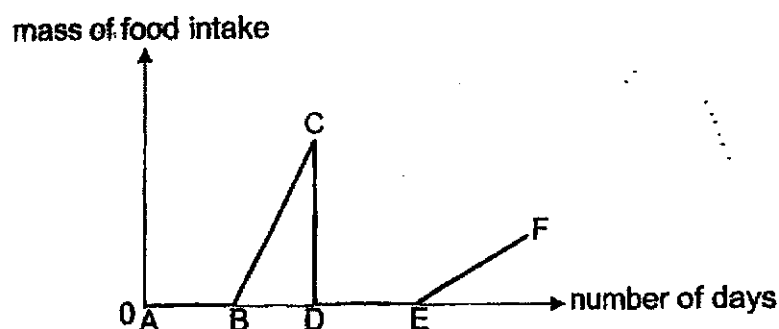

Based on the information above, which part of the graph represents the larval stage of the insect?

- (1) BC
 (2) CD
 (3) DE
 (4) EF

5 Which of the following is **not** an inherited characteristic?

- (1) fair-skin
- (2) long hair
- (3) sharp nose
- (4) blue-coloured eyes

6 The diagram shows a human reproductive system.

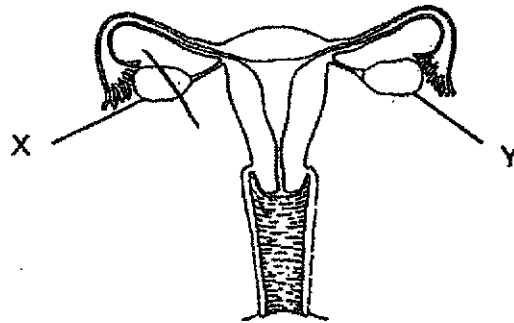

Which of the following statement(s) is/are true when only part X was removed?

- A No egg cells will be produced.
- B A baby can still develop in her reproductive system.
- C Fertilisation can still occur in her reproductive system.

- (1) A only
- (2) C only
- (3) A and B only
- (4) B and C only

7 Which of the following is correct?

(1)

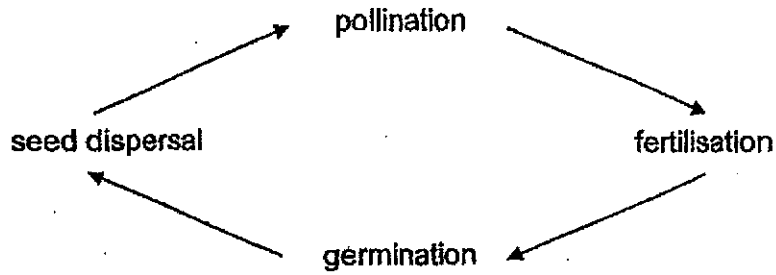

(2)

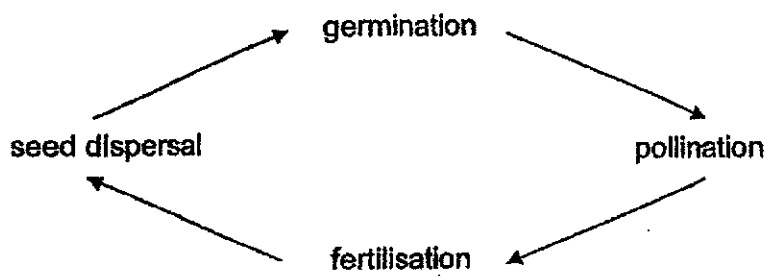

(3)

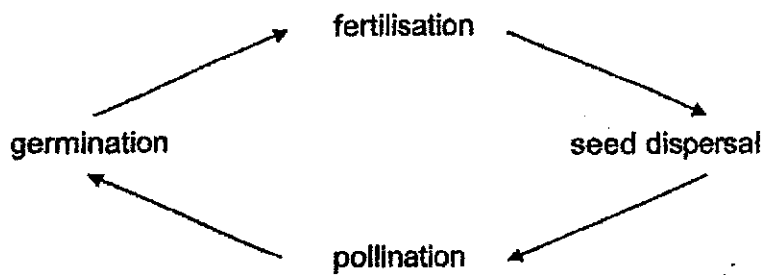

(4)

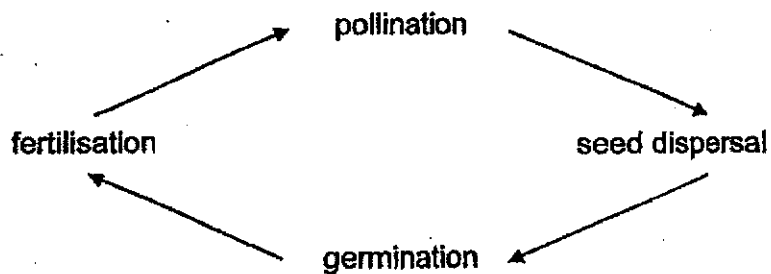

- 8 The diagram (not drawn to scale) below shows two pods, X and Y, dispersing their seeds when the pods split.

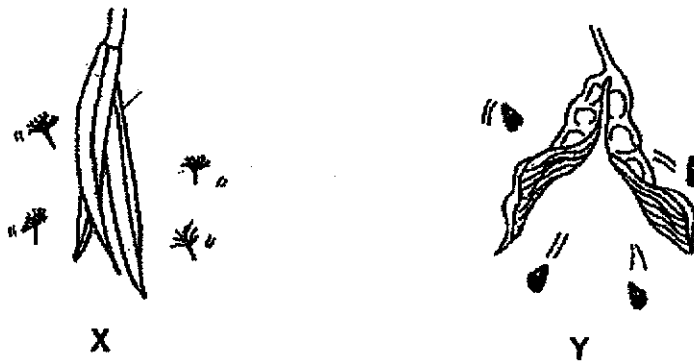

The diagrams below show the distribution of young plants observed over a period of time.

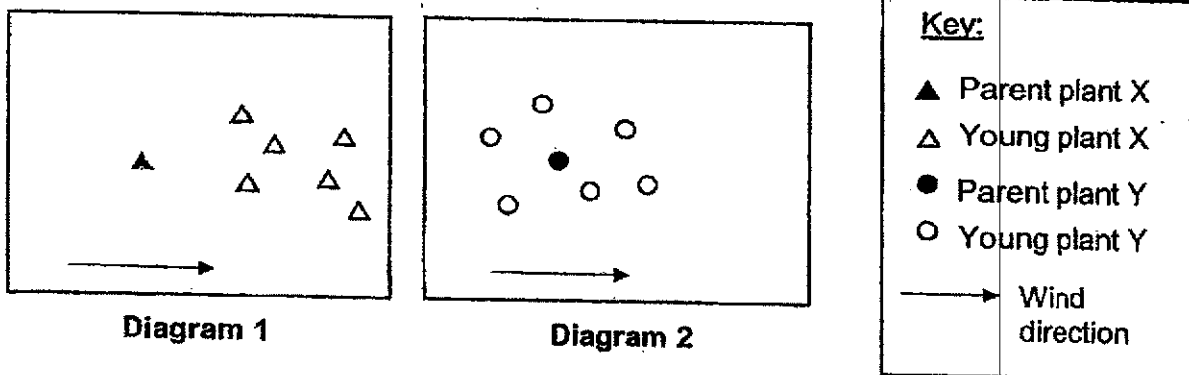

Based on the information provided above, which of the following is/are definitely true?

- A Seeds of fruit X are lighter than seeds of fruit Y.
 B Seeds of fruit Y are inedible but seed of fruit X is edible.
 C Seeds of fruit X can stay afloat in the air longer and be dispersed further.
 D Seeds of fruit X are dispersed by wind only while seeds of fruit Y are dispersed by splitting action only.

- (1) C only
 (2) A and C only
 (3) B, and D only
 (4) A, B, and D only

9 The diagram shows the functions of some parts of the human digestive system.

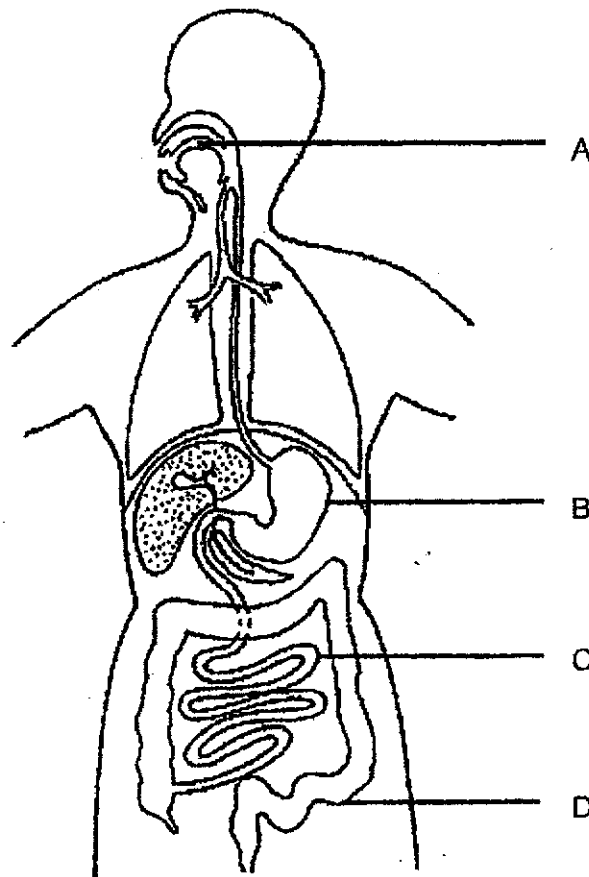

Which of the following statements about parts A, B, C and D is correct?

	Part	Statement
(1)	A	No digestion takes place
(2)	B	Digests food completely
(3)	C	Digests food completely and absorbs it into the bloodstream
(4)	D	Absorbs digested food and water

- 10 The diagram shows two plants, P and Q. Plant P grows in the water and plant Q grows on land.

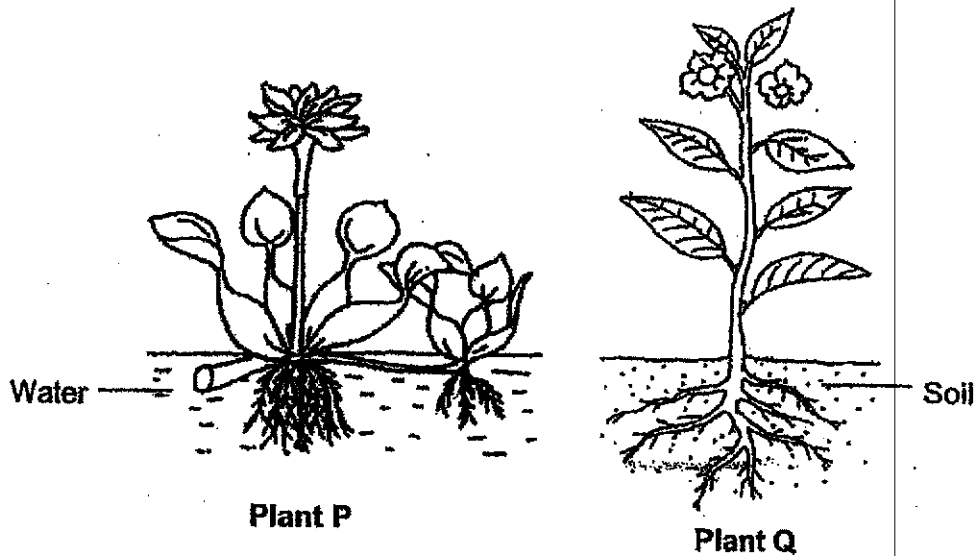

Which is/are the main function(s) of the roots of both plants P and Q?

- A To store food
- B To take in water and nutrients
- C To hold a plant down in the soil

- (1) B only
- (2) A and B only
- (3) B and C only
- (4) A, B, and C

- 11 The diagram below shows two cells, A and B, examined under the microscope.

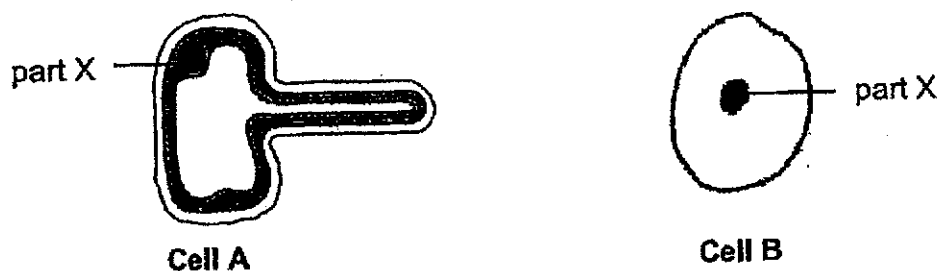

Which of the following correctly identify cells A and B and the function of part X?

	Type of cell		Function of part X
	Cell A	Cell B	
(1)	plant	plant	control all activities within the cell
(2)	plant	animal	control all activities within the cell
(3)	plant	plant	captures sunlight for the plants to make food
(4)	plant	animal	captures sunlight for the plants to make food

12. Clara prepared an experimental set-up by placing a plant under strong light as shown below.

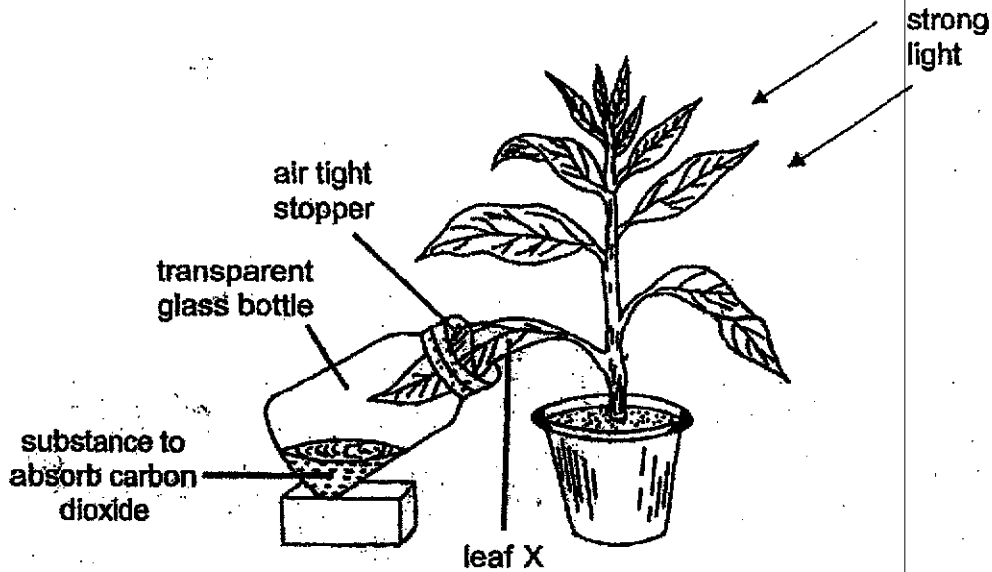

After eight hours, she removed leaf X from the plant and tested for the presence of starch.

She placed leaf X in a beaker of boiling water for twenty minutes and then placed the leaf on a white tile as shown below. She added a few drops of yellowish-brown iodine solution on the whole leaf.

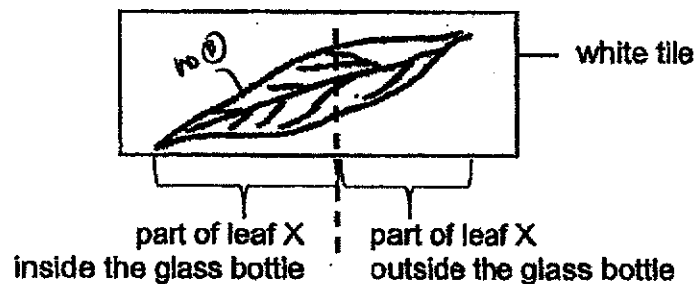

She recorded her observations in the table below. Based on the information above, which of the following is correct?

	Colour of iodine solution on part of leaf X inside the bottle	Colour of iodine solution on part of leaf X outside the bottle
(1)	Yellowish-brown	Dark blue
(2)	Yellowish-brown	Yellowish-brown
(3)	Dark blue	Yellowish-brown
(4)	Dark blue	Dark blue

13 Volcano scientists wear lava suits to work close to hot molten lava as shown below.

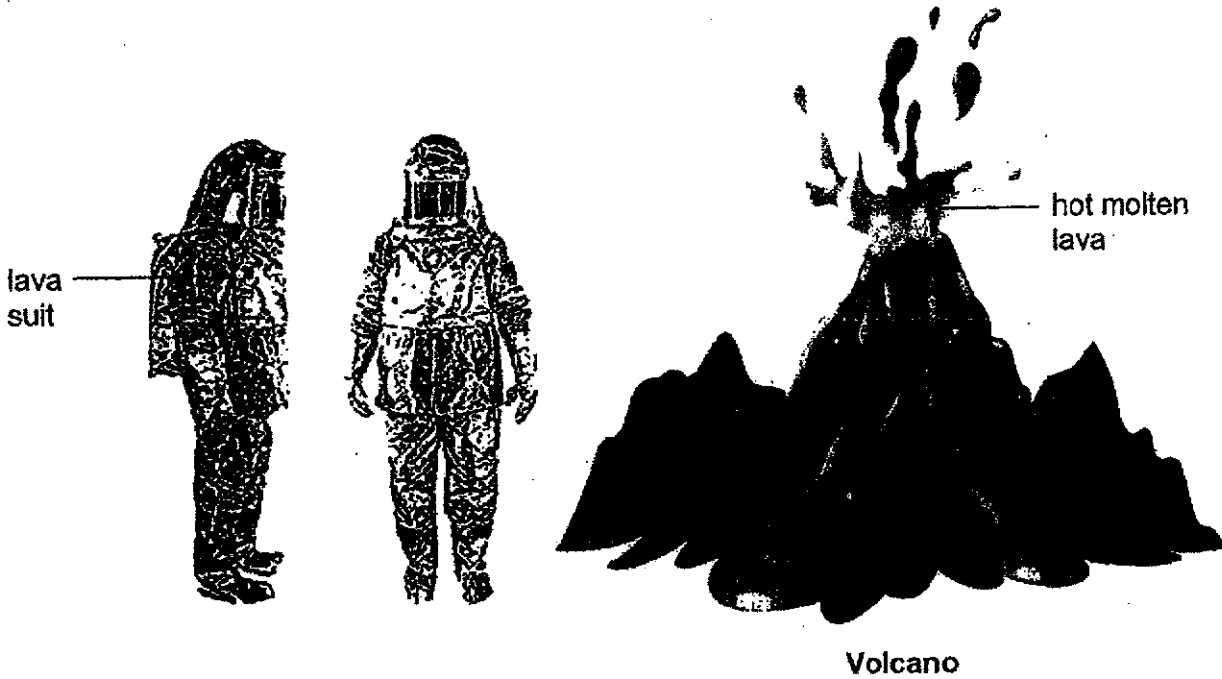

Based on the properties shown below, which material is most suitable for making a lava suit?

	Material	Property			
		Flexible	Strong	Waterproof	Heat Conductivity
(1)	P		√	√	good
(2)	Q	√	√	√	poor
(3)	R		√		poor
(4)	S	√	√		good

- 14 Ali received three parcels, D, H and L, that contained styrofoam balls, dish sponges and feathers respectively. He was also given a lever balance to compare the mass of parcels.

Parcel Size	D	H	L
Parcel Contents	Styrofoam balls	Dish sponges	Feathers
Total Parcel Mass	150 g	300 g	150 g

Which of the following diagrams best shows how the lever balance would look like?

(1)

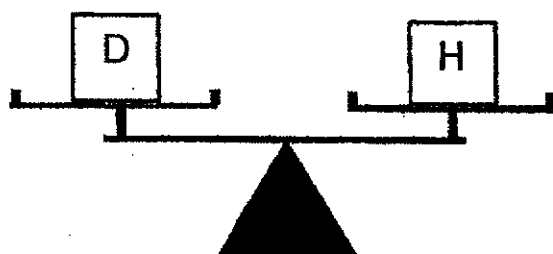

(2)

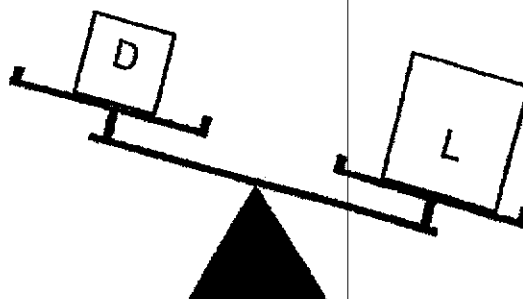

(3)

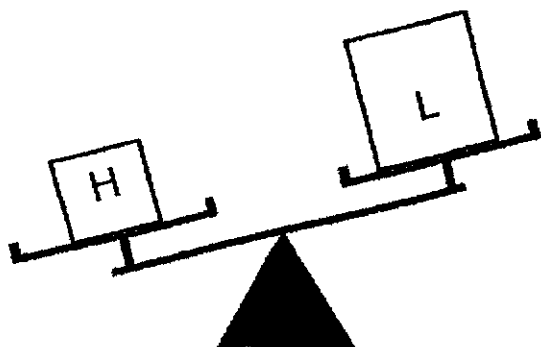

(4)

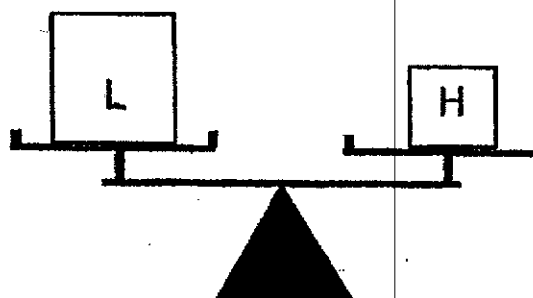

- 15 Roy prepared four set-ups, A, B, C and D, using identical measuring cylinders each containing 20 cm³ of water. He placed identical corks and metal cubes in the four set-ups as shown below.

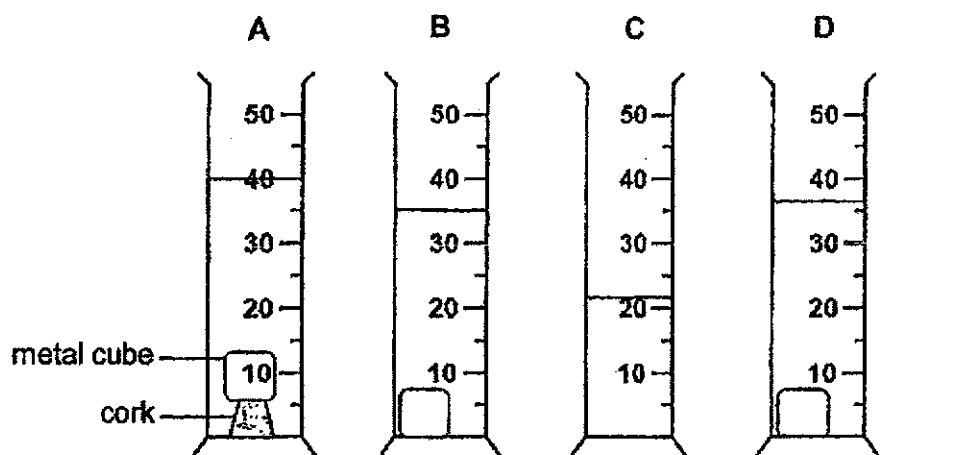

Based on the observation above, what is the volume of the cork and the metal cube respectively?

	Volume of cork (cm ³)	Volume of metal cube (cm ³)
(1)	5	15
(2)	5	35
(3)	7	25
(4)	12	35

- 16 A beaker of boiling substance X was taken off the heat source at K and left to cool in the freezer. The changes in temperature of the substance X over time were recorded and shown in the graph below.

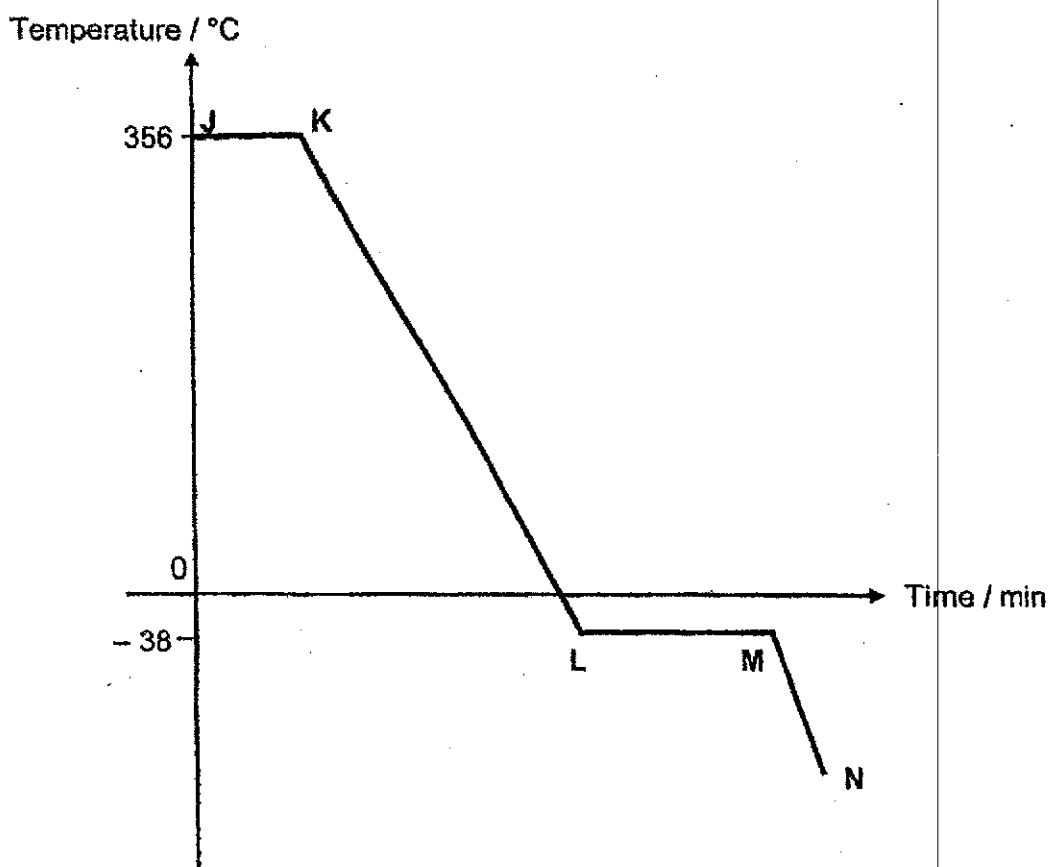

Based on the graph, which of the statement(s) about substance X below is/are true?
It is _____.

- A gaining heat at JK
- B in liquid state at KL
- C gaining heat at LM
- D in solid state at MN

- (1) B only
- (2) A and C only
- (3) B, C and D only
- (4) A, B and D only

- 17 Sue set up an electrical circuit to find out the electrical conductivity of materials Q, R and S. All the components used in the circuit shown below were in working condition.

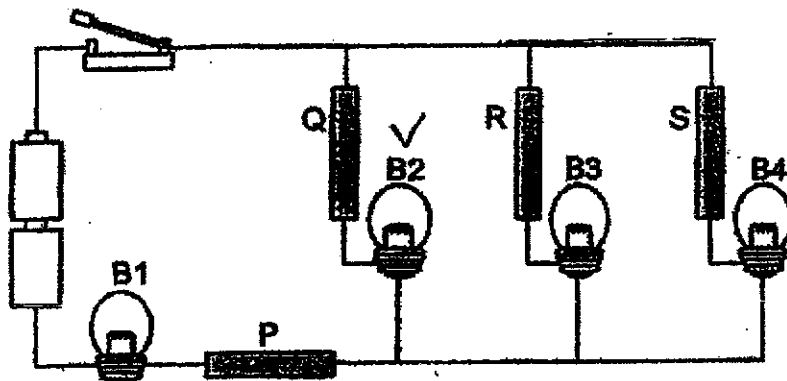

Sue observed that when the switch was closed, only bulbs B2 and B4 lit up.

Which of the following materials is/are insulator(s) of electricity?

- (1) R only
- (2) P and R only
- (3) Q and S only
- (4) P, Q and S only

18. Siti conducted an experiment with one of the four circuits, prepared using identical components, as shown below. She then recorded her results in a table as shown below.

Switch Y	Switch Z	Number of bulbs lit
open	close	2
close	open	1
close	close	2

Which of the following circuits did Siti use?

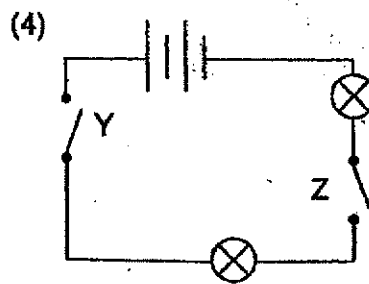
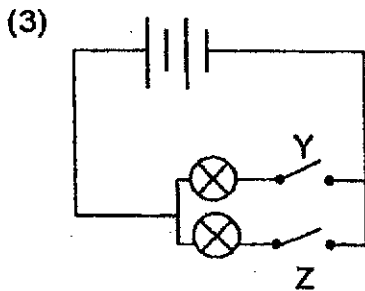
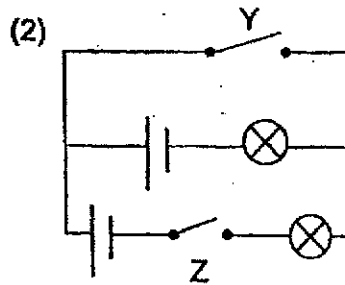
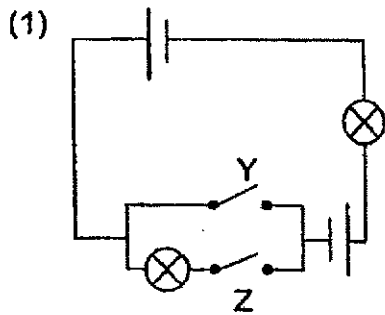

- 19 The diagrams, A and B, below show how a high speed train can move forward faster than a normal train.

Diagram A shows the electromagnet under the train and on the train track. Diagram B shows the rows of magnets lined along the side of the train and inner side of the beam. The arrows show the directions of interactive magnetic force amongst the magnets as the train travels.

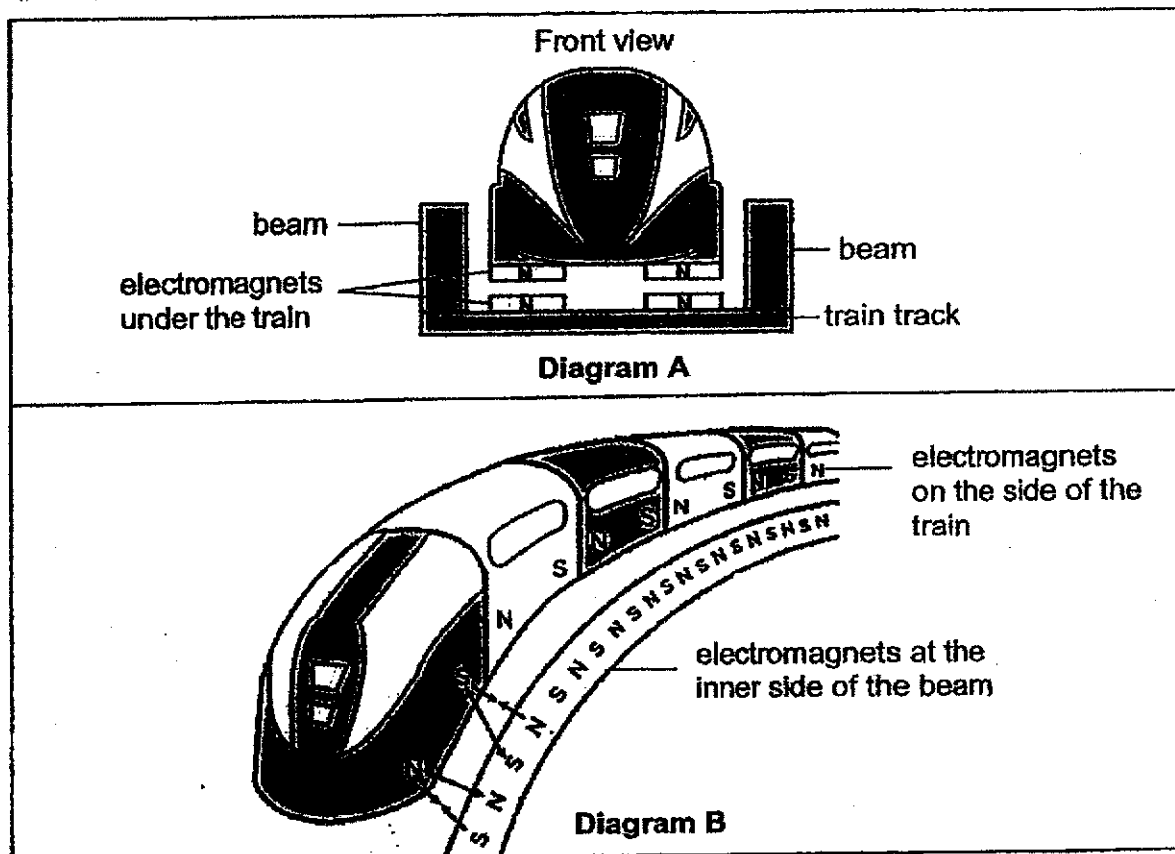

Which of the following explanations about the interaction amongst the magnets shown in diagrams A or B is correct?

	Diagram	Poles of electromagnet facing each other	Result of interaction between electromagnets
(1)	A	Like poles	They attracted to pull the train forward faster.
(2)	A	Like poles	They repelled to push the train off the ground to increase friction as the train moved forward faster.
(3)	B	Like poles	They attracted to pull the train forward faster.
		Unlike poles	They repelled to push the train forward faster.
(4)	B	Like poles	They repelled to push the train forward faster.
		Unlike poles	They attracted to pull the train forward faster.

- 20 Raj dropped two identical pieces of paper, A and B, from the same height. He crushed paper A before he dropped them.



Paper A

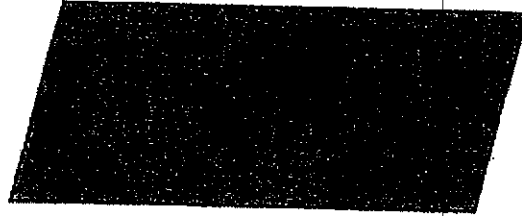

Paper B

Which of the following is likely to be the correct observation and the corresponding reason?

	Observation	Reason
(1)	Paper A landed on the ground faster.	It had more frictional force acting on it.
(2)	Paper A landed on the ground slower.	It had less exposed surface area.
(3)	Paper B landed on the ground faster.	It had greater exposed surface area.
(4)	Paper B landed on the ground slower	It had more frictional force acting on it.

- 21 The diagram below shows a hammock holding a baby that moves up and down from position A to B, and then from B to A repeatedly.

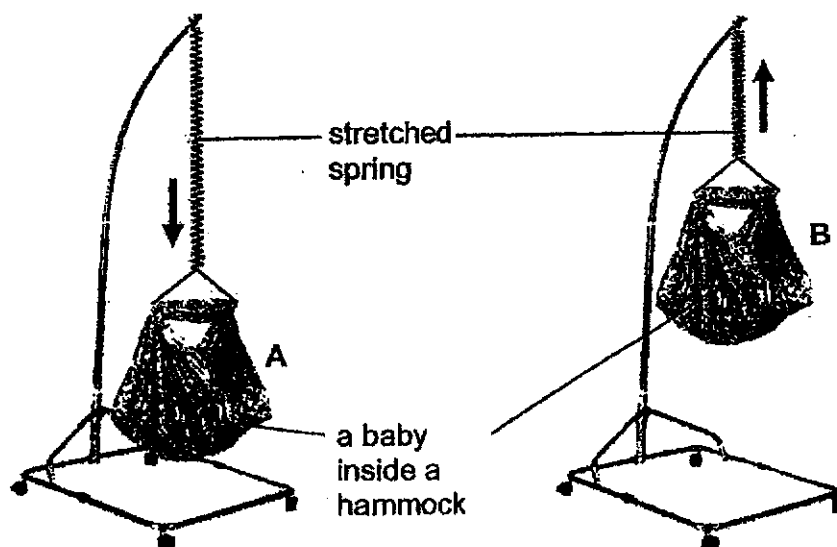

Which of the following statement(s) about the above hammock is/are true?

- A More gravitational force is acting on the baby at B than A.
- B Frictional force is acting on the baby as she moves from A to B.
- C Elastic spring force is pulling the baby in the opposite direction of her weight.
- D Elastic spring force acting on the hammock is increasing as it moves from A to B.

- (1) B only
- (2) A and D only
- (3) B and C only
- (4) A, C and D only

- 22 Anne made a paper butterfly. She attached the paper butterfly and an inflated balloon on the top and bottom of a straw respectively, as shown below. She then put a string through the straw before attaching it onto two poles.

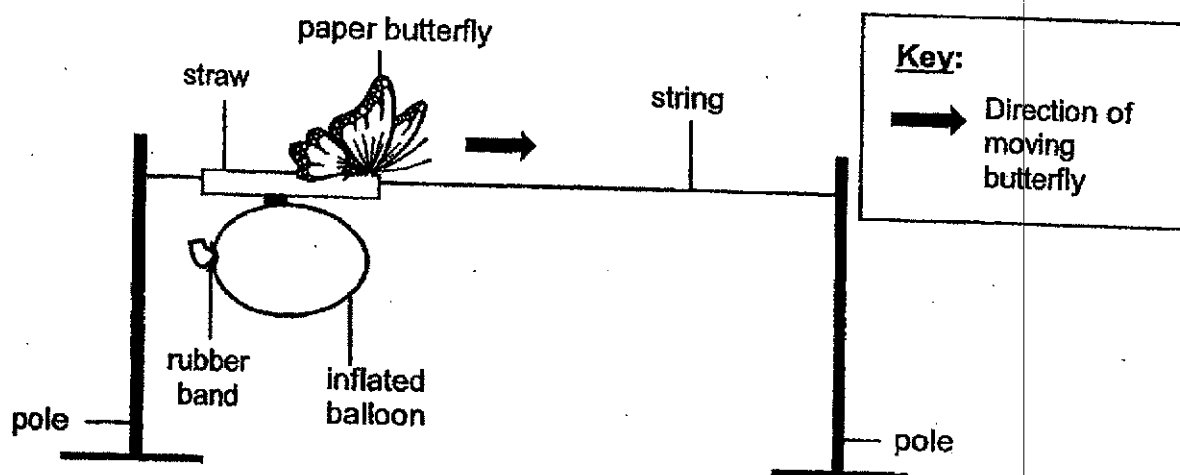

Which one of the following explains how the paper butterfly moved when the air was released from the untied inflated balloon?

The force exerted by the moving air was _____.

- (1) greater than the weight of the string
- (2) less than the weight of the straw
- (3) greater than the friction between the string and straw
- (4) less than the friction between the balloon and string

- 23 An experiment was set up to find out the degree of transparency of four sheets of material A, B, C and D. Sheets A and B had cut-outs of different shapes, as shown below.

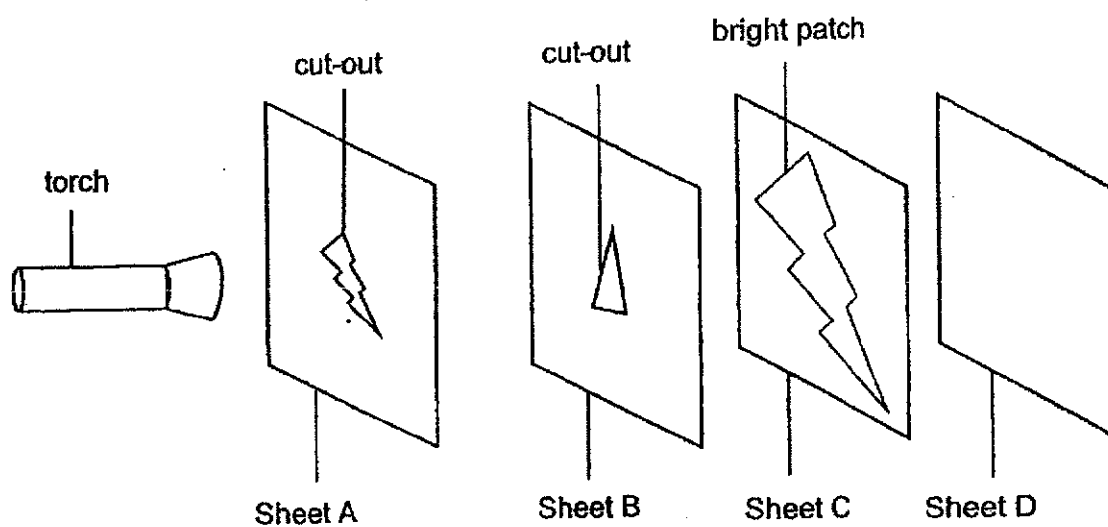

Which one of the following correctly describes the properties of sheets A, B, C and D?

	Allows light to pass through	Does not allow light to pass through	Not possible to tell
(1)	D	A	B and C
(2)	B	A and C	D
(3)	B	C	A and D
(4)	C and D	B	A

- 24 Peter made an object by attaching a wooden disc on a frosted rectangular glass block. He wanted to find out how the different positions, A and B, of the torch would affect the shadow of the object cast on the screen. The experimental set-up is shown below.

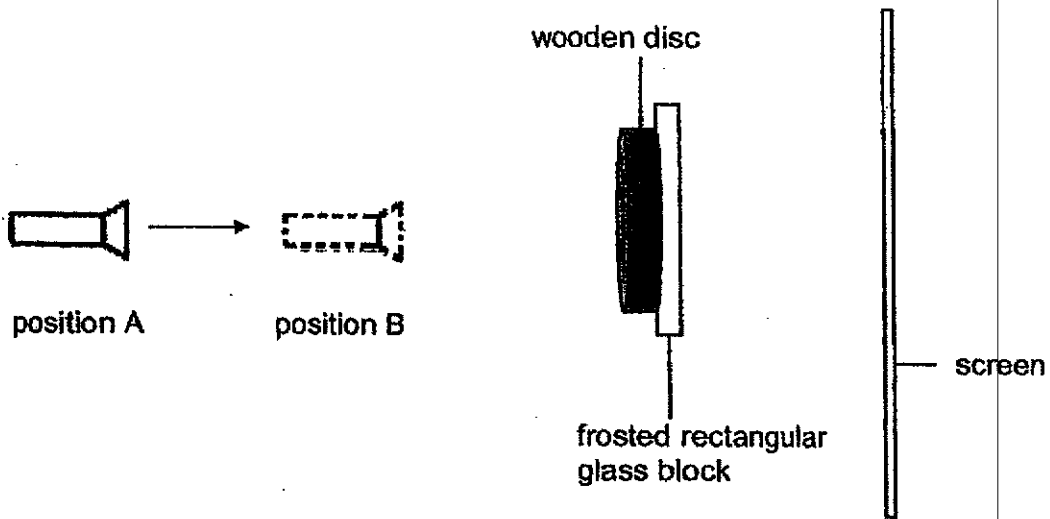

Which of the following shows the changes in the shadow of the object cast on the screen?

	Shadow formed when torch was at position A	Shadow formed when torch was at position B
(1)		
(2)		
(3)		
(4)		

- 25 The diagram below shows an ice cube placed on a metal sheet.



After a while, Martha touched the ends of the metal sheet and her fingers felt cold.

Which one of the following is a possible reason for Martha's observation?

- (1) Her fingers lost heat to the metal sheet.
 - (2) Her fingers gained heat from the ice cube.
 - (3) The ice cube lost heat to the metal sheet.
 - (4) The ice cube gained heat from the surrounding air.
- 26 An experiment was conducted by placing two identical beakers each containing 100 ml of the same liquid in a room with a constant temperature of 25°C. The temperature of the liquid in each beaker was different.

After four hours, the temperature of the liquids in both beakers became the same and the volume of liquid left in each beaker was recorded in the table below.

Beaker	Initial temperature (°C)	Initial volume of liquid (ml)	Volume of remaining liquid (ml)
A	T	100	85
B	70	100	70

Then a fan was placed above one of the beakers for six hours. The volume of liquid left in each beaker was recorded in the table below.

Beaker	Volume of remaining liquid (ml)
A	65
B	65

Which of the following correctly identifies the beaker exposed to a fan and the initial temperature, T , of the liquid in beaker A?

	Beaker	T (°C)
(1)	A	40
(2)	B	40
(3)	A	80
(4)	B	80

- 27 The diagram below shows two toys, C and D, which are used to shoot a ping pong ball.

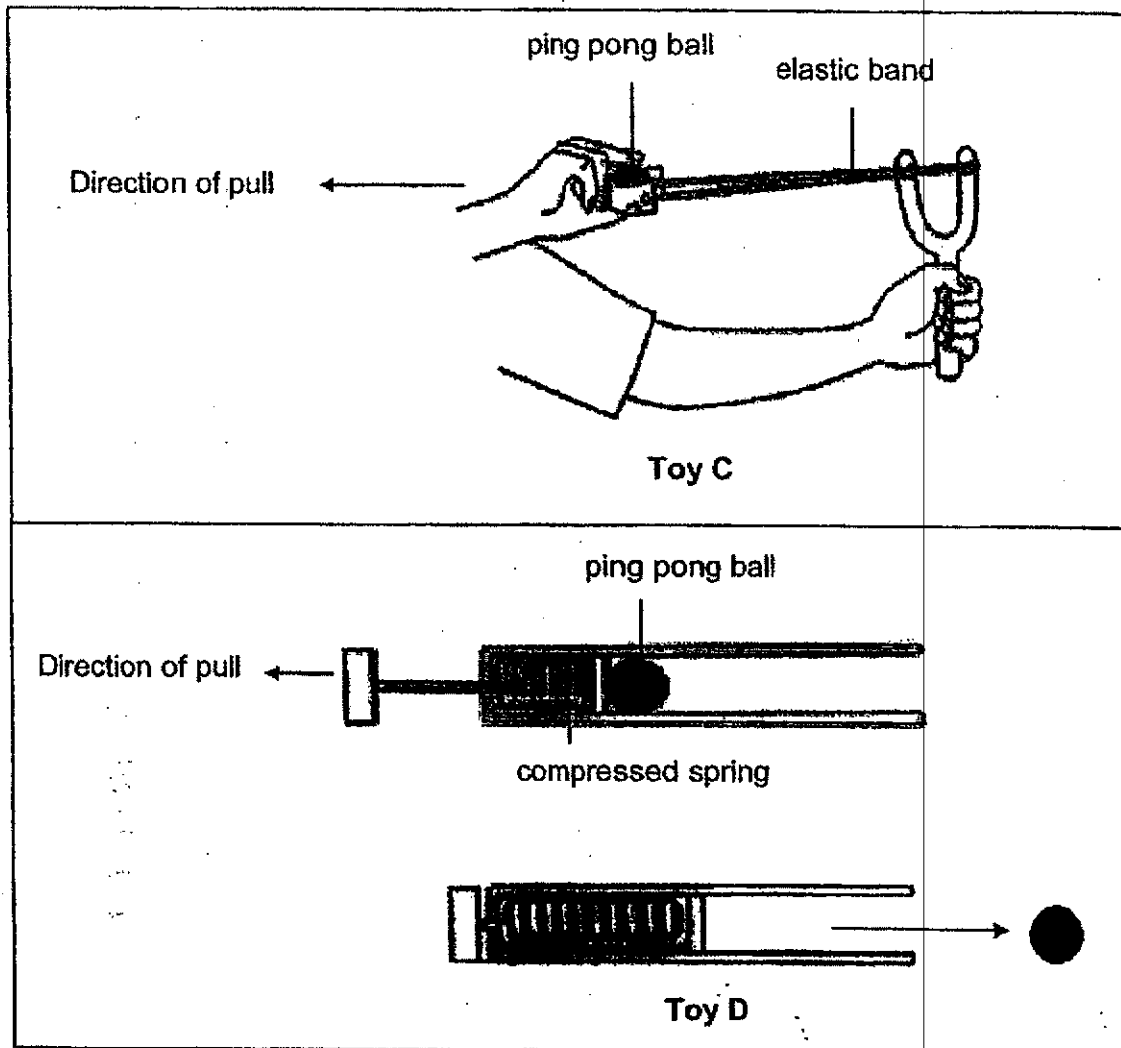

The ping pong ball in Toy C will shoot forward when the elastic band is released.
The ping pong ball in Toy D will shoot forward when the handle is released.

Continue on next page

Continued from previous page

Based on the information provided, which of the following graphs shows the relationship between the length of the pull and the elastic potential energy in both toys?

	Toy C	Toy D
(1)		
(2)		
(3)		
(4)		

- 28 The diagram below shows a man walking on a pavement lined with special tiles. During the day, when a person steps on the tiles, electricity is generated. The battery stores energy which is used to light up the street lamps at night.

special tile 

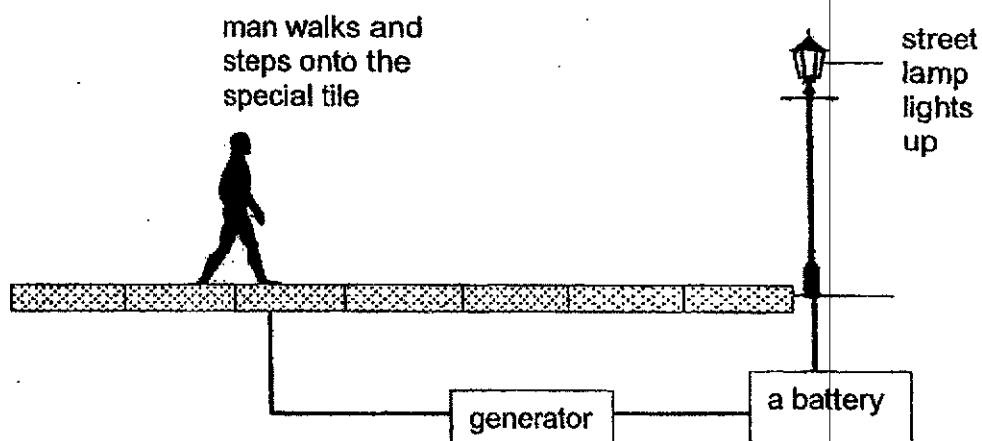

Based on the information above, which of the following statement(s) is/are correct?

- A The amount of electricity stored in the battery increases, as the number of people walking on the pavement increases.
- B The amount of electrical energy generated increases, as the number of people walking on the pavement increases.
- C As the number of people walking on the pavement increases, the amount of chemical potential energy in the battery decreases.

- (1) B only
- (2) C only
- (3) A and B only
- (4) A, B, and C

Name: _____ Index No: _____ Class: P6 _____

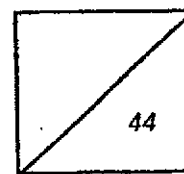
**SECTION B (44 marks)**

For questions 29 to 41, write your answers clearly in the spaces provided.

The number of marks is shown in brackets [] at the end of each question or part question.

- 29 Sandra carried out an experiment by placing identical bread slices, A, B and C, into each sealed airtight bags before exposing each of them to different conditions as shown below.

Bread slice	Number of drops of water added	Location
A	15	freezer
B	2	enclosed cupboard
C	15	window sill

- (a) Which bread slices should Sandra use to find out if warmth is required for the growth of bread moulds? [1]

She observed the surface area of the bread slices covered with bread moulds over three days and recorded the results in the graph below.

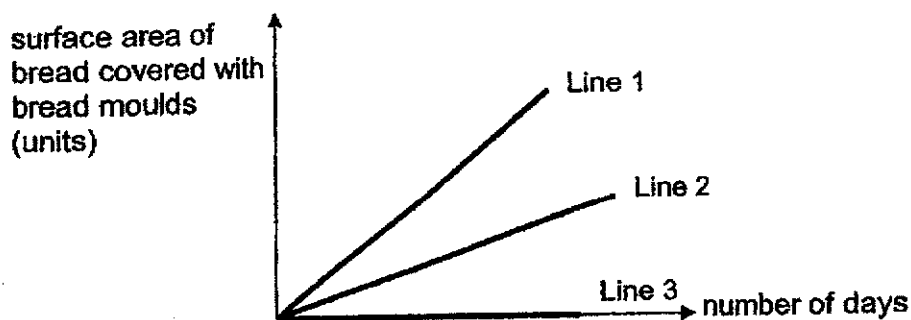

- (b) Which of the lines, 1, 2 or 3, correctly represents the results observed on bread slice A? Give a reason for your answer. [2]

Score	3
-------	---

- 30 Organisms X are commonly found on the flowers of plant R.
The table shows some characteristics of plant R and organism X.

Plant R	Organism X
<ul style="list-style-type: none"> flowers contain either female or male parts flowers give out a sweet-smelling scent produces edible and fleshy fruits with many tiny, seeds 	<ul style="list-style-type: none"> has a hairy body feeds on nectar

- (a) Describe how the organisms X can help to pollinate the plant R. [2]

- (b) Based on the information above, suggest a dispersal method for the fruit of plant R. Explain how the seeds of its fruit are being dispersed. [2]

Score	4
-------	---

- 31 The diagram below shows two human systems namely system Z and the circulatory system. The arrows show the direction of movement of two gases entering and leaving the human systems.

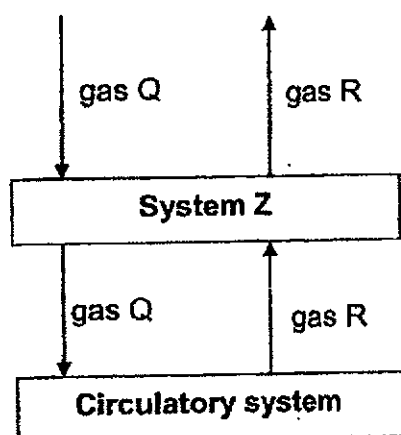

- (a) Identify gas Q and system Z. [1]
- (i) gas Q: _____
- (ii) system Z: _____
- (b) Which part of the plant performs similar function as system Z? Explain your answer. [1]
- _____
- _____
- (c) Why is gas R important to plants? [1]
- _____
- _____

Score	3
-------	---

32 Siva connected a syringe to a container with a capacity of 300 cm^3 as shown below.

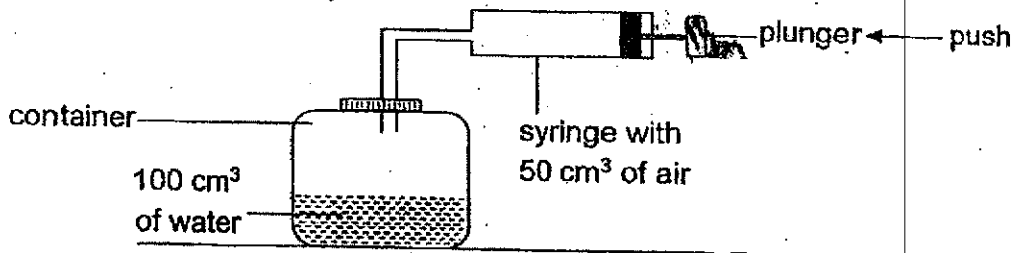

(a) After he had used two identical syringes and pumped 50 cm^3 of air into the container one at a time, what would be the volume of air in the container?

[1]

(b) Would the mass of air in the container increase, decrease or remain the same after two pumps of air had entered the container? Give a reason for your answer.

[1]

Siva inflated his boat and went for a full-day paddle on a hot day as shown below.



He was advised not to pump too much air while inflating the boat so that it would feel firm and not hard. It was to prevent the boat from tearing while he was paddling under the Sun.

(c) Explain why there could be a possible tear in the over-inflated boat while he was paddling under the Sun.

[1]

Score	3
-------	---

- 33 Doctors Peter and John, wearing spectacles made of identical materials, had a discussion in an air-conditioned room. It was observed that the inner surfaces of Doctor Peter's spectacle lenses fogged up each time he spoke but Doctor John's spectacle lenses remained clear throughout the discussion.

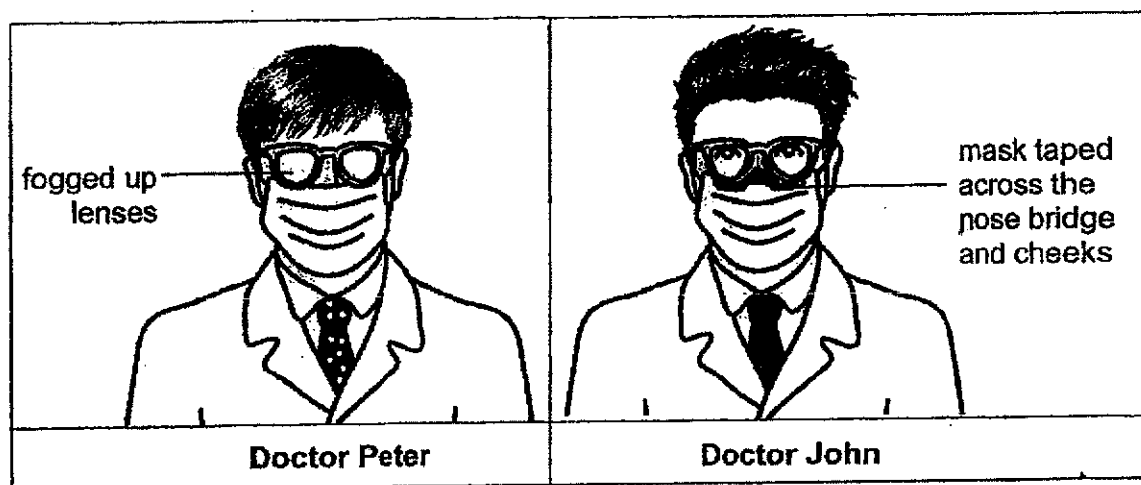

- (a) Explain why Doctor John's spectacle lenses did not fog up. [2]

When they moved to the outdoor garden to have their discussion, Doctor Peter observed that there was less fogging on the inner surfaces of his spectacle lenses compared to when he was in the air-conditioned room.

- (b) Explain his observation. [1]

Score	3
-------	---

34 Siti designed a Ball Toss Game for her school carnival as shown below.

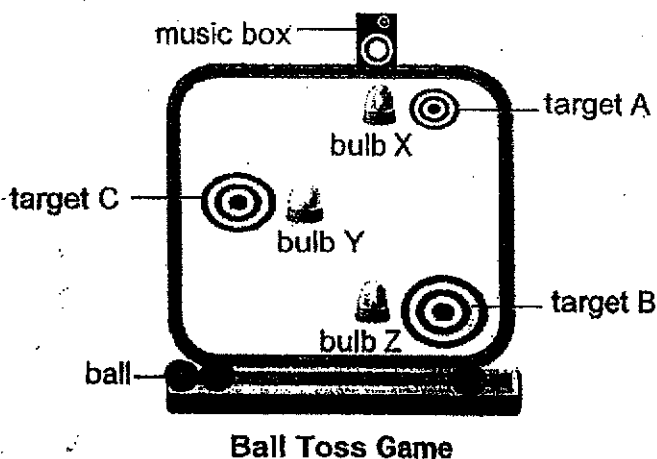

She wanted to set up an electrical circuit in the Ball Toss Game using the following working components.

- | | | | | |
|-----------|--------------|---------------|---------|---------------|
| • 3 bulbs | • 3 switches | • 3 batteries | • wires | • a music box |
|-----------|--------------|---------------|---------|---------------|

Each bulb, X, Y and Z, had to be controlled by a separate switch found under each target. If either target B or C was hit, the switch would close and only the bulb next to it would light up.

If target A was hit, the switch would close and only bulb X would light up and the music box would play a victory tune at the same time.

Based on the information given, complete the circuit diagram below. [3]

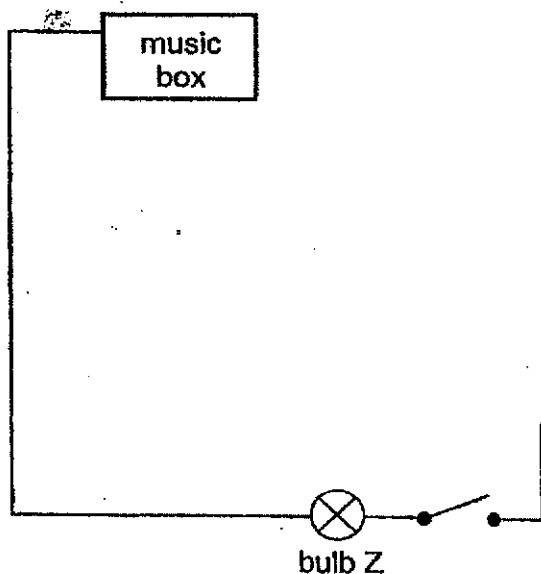

Score	3
-------	---

35 Amy bought a facial mask set which consisted of a mask cream containing a metal-based substance which helped to cleanse her face. She used the handheld mask-removal tool with Plate X, held at a distance from her face, to remove the mask as shown below.

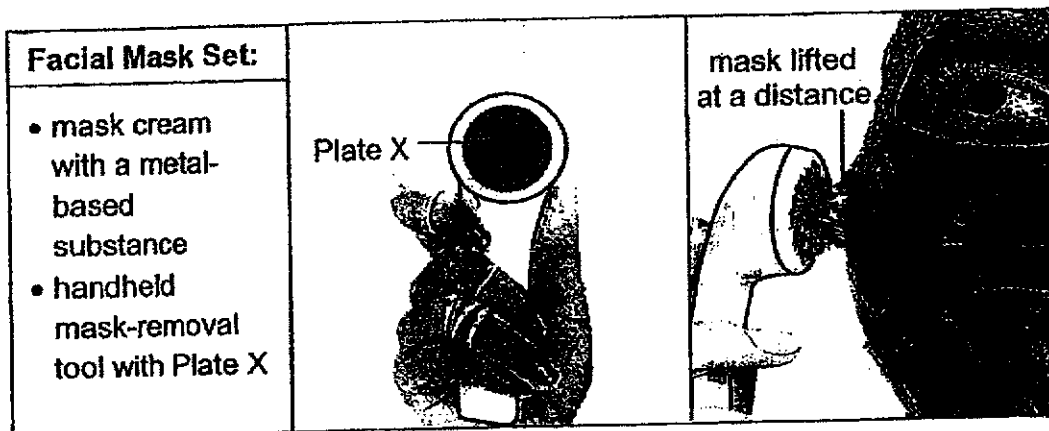

(a) Based on the information above, what could Plate X be? [1]

Amy's friend told her that the metal-based substance added to the mask cream could be made of silver.

(b) Do you agree with Amy's friend? Explain why. [2]

Amy then bought a different handheld mask removal tool and used the same mask cream of an identical amount to cleanse her face. She held the new handheld mask-removal tool at the same distance away from her face. She observed that it removed less mask from her face within the same period of time.

(c) Give a reason for her observation made when the new handheld mask removal tool was used. [1]

Score	4
-------	---

36 Joe conducted an experiment using the set-up as shown below.

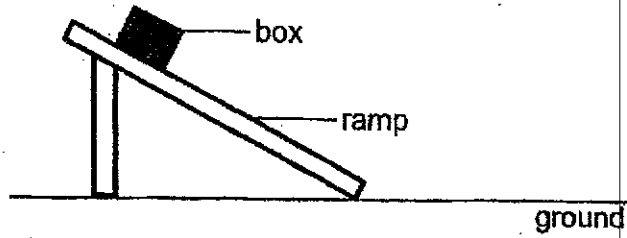

From the same starting point on the ramp, he released boxes A, B and C, made of identical materials, one at a time. Then he measured the time taken for each box to reach the ground.

Box	Mass (g)	Area of contact with the ramp (cm ²)	Time taken for box to reach the ground (s)
A	8	50	3
B	4	150	6
C	8	100	3

(a) Based on the results above, did the area of contact with the ramp affect the amount of friction acting on the box? Explain your answer. [1]

Snow chains are fitted to the tyres of vehicles during winter as a safety measure while driving on icy road surfaces as shown below.

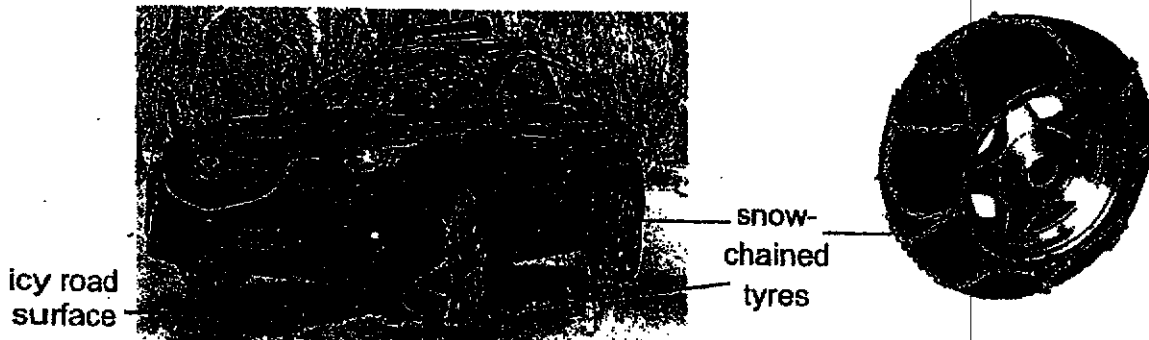

(b) Explain how the snow-chained tyres act as a safety measure while the vehicles are driven on icy road surfaces. [2]

Score	3
-------	---

- 37 Tony prepared a ball of dough to make a pizza. He took a rolling pin to flatten the ball of dough as shown in the diagram below.

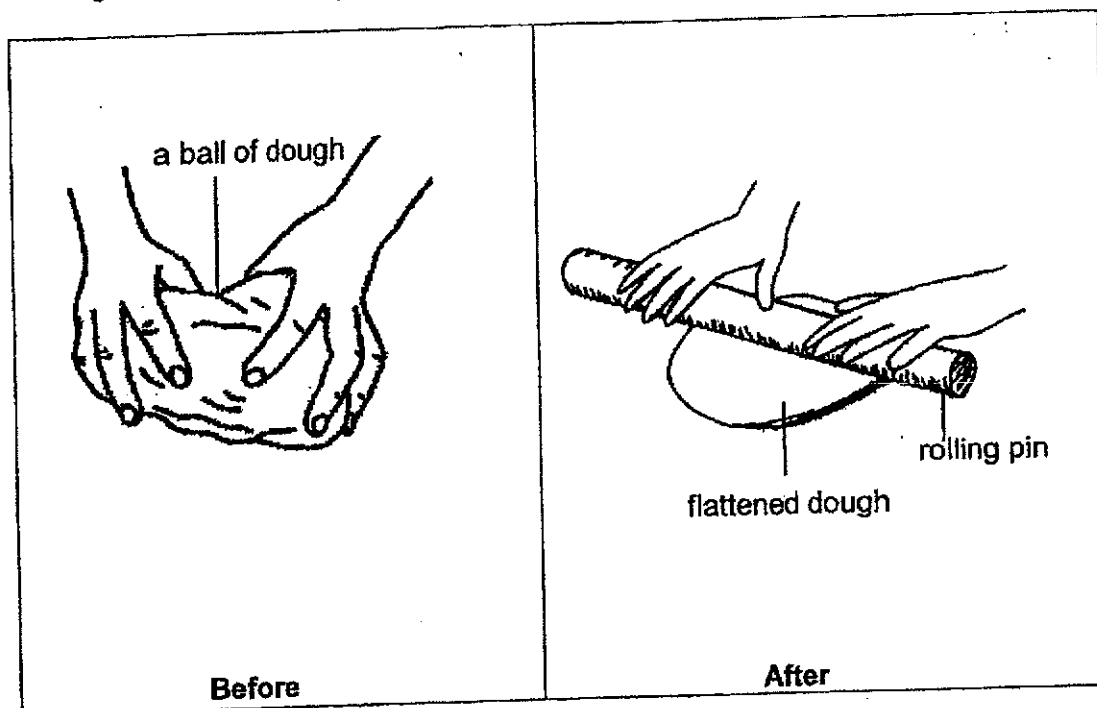

- (a) State the effect of the force exerted by the rolling pin on the ball of dough. [1]

Continue on next page

Score	1
-------	---

Continued from previous page

Then Tony tossed the flattened dough into the air to stretch it further to increase its size as shown in the diagram below.

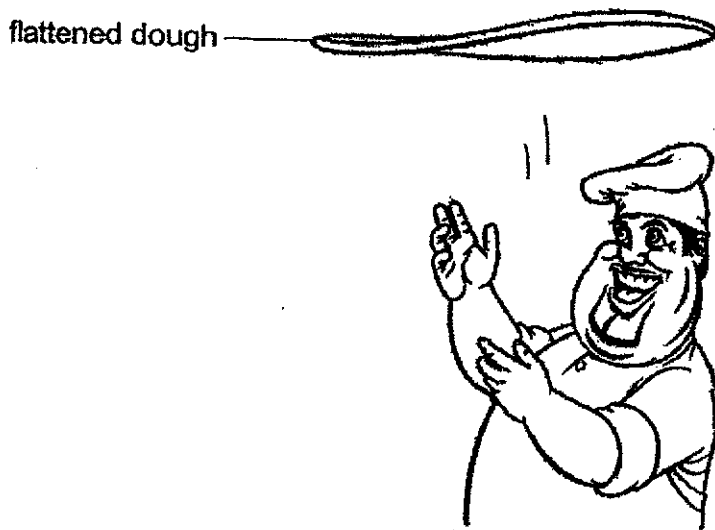

- (b) Draw a line graph in the space below to show the amount of gravitational force acting on the flattened dough as it was being tossed into the air. [1]

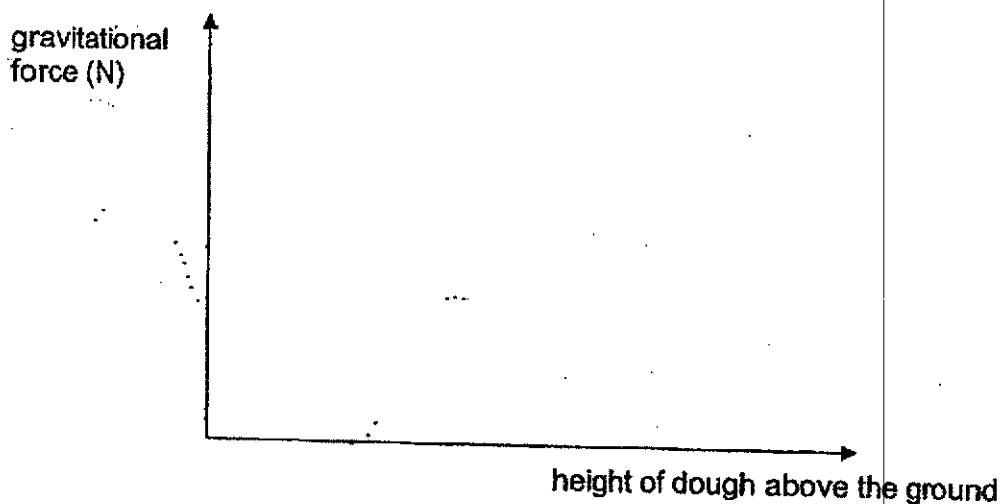

- (c) Explain, in terms of forces, how the flattened dough was able to move up into the air when Tony tossed it. [1]

Score	2
-------	---

- 38 Mary wanted to find out if the presence of substance A will affect the degree of transparency of a liquid. She prepared the set-up using 400 ml of liquid X and conducted the experiment in a dark room as shown below.

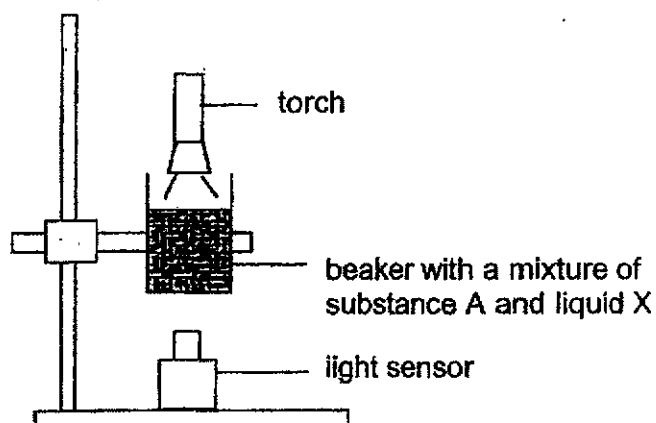

- (a) Describe how Mary should prepare a control set-up for the experiment. [1]

- (b) Explain why Mary conducted the experiment in a dark room. [1]

- (c) Mary wanted to compare how the presence of different substances would affect the degree of transparency of a liquid.

She repeated the experiment by replacing substance A with B using 400 ml of liquid Y instead.

Her classmate commented that it was not a fair test. Do you agree? Explain your answer. [1]

Score	3
-------	---

39 Ben could not open the glass jar with a tight lid hence he placed the jar into a tub of hot water as shown below.

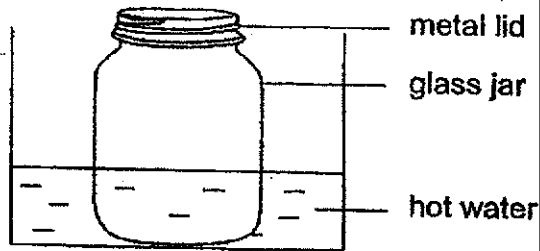

(a) After five minutes, Ben still could not open the glass jar.

(i) Without using different apparatus or additional materials, suggest what Ben could do in order to open the glass jar. [1]

(ii) Explain your answer in (a)(i). [2]

(b) Two identical metal cups were stuck together and needed to be separated. Put a tick (✓) in the correct box(es) to indicate which of the following is/are needed to separate the cups most quickly. [1]

Items needed	Tick(✓)
Ice cubes	
Hot water	
Tap water	

Score	4
-------	---

- 40 Tom and Judy prepared identical hot moist towels, A and B, respectively to welcome the hotel guests. Tom rolled up towels A while Judy laid towels B flat as shown in the diagram below.

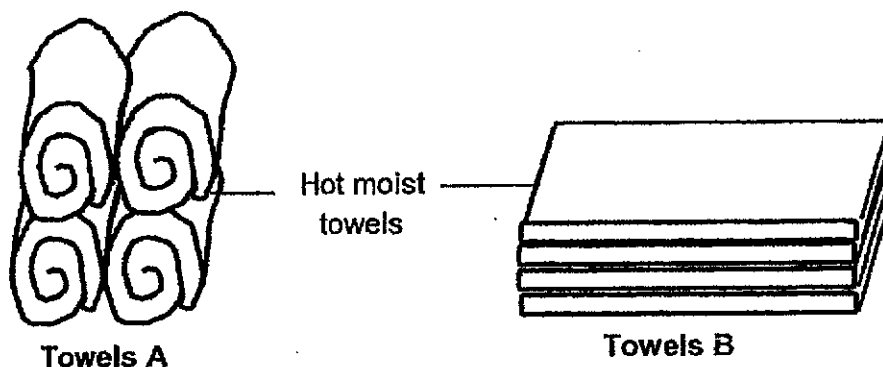

- (a) Five minutes later, Tom observed that the towel from the top of the stack of towels B was much cooler than one of the rolled-up towels on the top stack of towels A. Explain the observation. [1]

To keep the hot moist towels A hot, Judy suggested storing them in a covered box before distributing to the guests. They put towels A in two different boxes made of metal and wood respectively as shown below. They measured the temperature of towels A in both boxes after fifteen minutes.

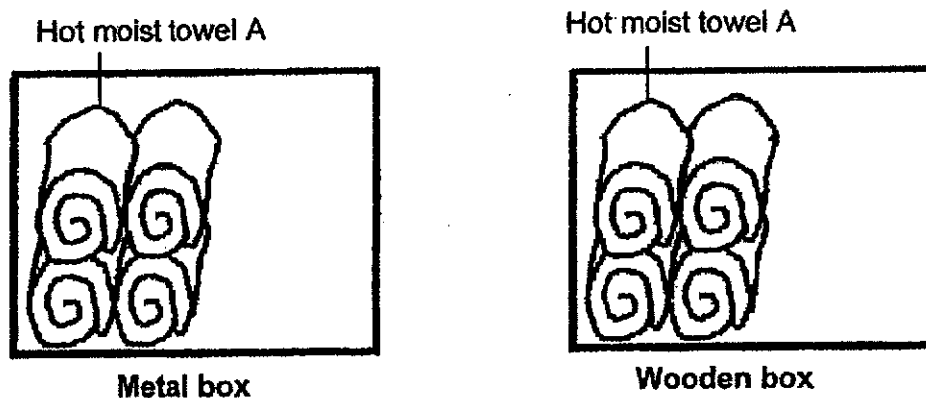

Continue on next page

Score	1
-------	---

Continued from previous page

They recorded the results in the table below.

Time (min)	Temperature of Towel A ($^{\circ}\text{C}$)	
	(b)(i) _____ box	(b)(ii) _____ box
0	55	55
15	40	48

- (b) Based on the information, fill in the words 'metal' and 'wooden' in the correct blanks in the result table above. [1]
- (c) Explain your answer in (b)(ii). [2]

Score	3
-------	---

41 Gabby prepared a set-up as shown below.

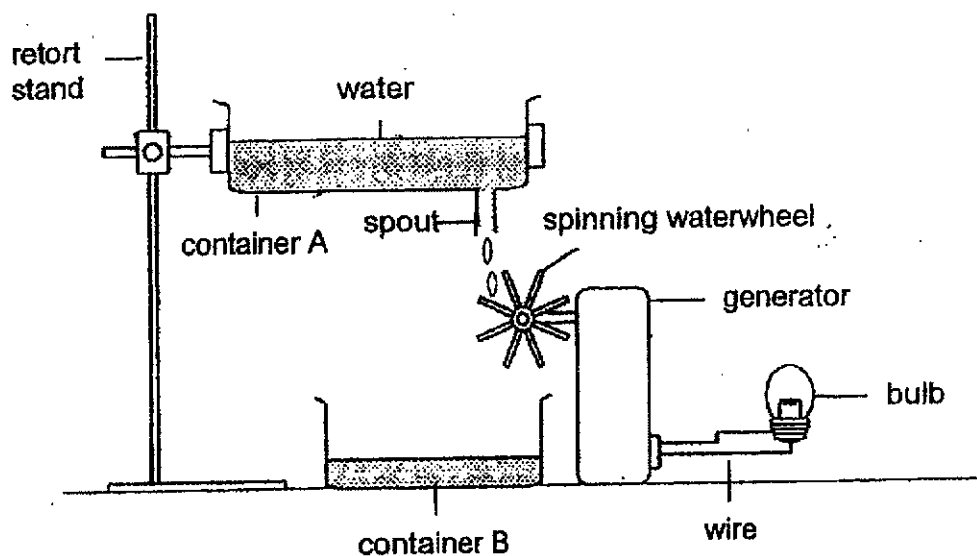

(a) State the main energy conversion as the water falls from the container A. [2]

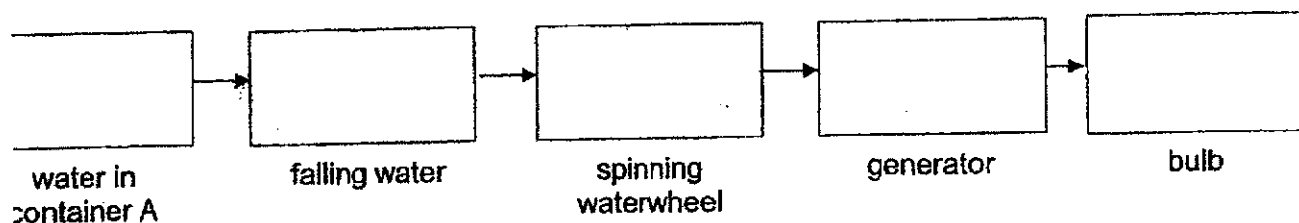

(b) Water was splashing off the water wheel and making a mess, so Gabby adjusted the retort stand to lower the spout of Container A closer to the water wheel. She noticed that the water wheel was still spinning, but the light bulb became dimmer.

Explain why the bulb became dimmer. [2]

END OF PAPER

Score	4
-------	---

SCHOOL : RAFFLES GIRLS' PRIMARY SCHOOL
LEVEL : PRIMARY 6
SUBJECT : SCIENCE
TERM : 2021 PRELIM

Contact

SECTION A

Q1	Q2	Q3	Q4	Q5	Q6	Q7	Q8	Q9	Q10
1	4	1	1	2	4	2	1	3	1
Q11	Q12	Q13	Q14	Q15	Q16	Q17	Q18	Q19	Q20
2	1	2	3	1	4	1	1	4	4
Q21	Q22	Q23	Q24	Q25	Q26	Q27	Q28		
3	3	2	3	1	1	1	1		

SECTION B

Q29)	<p>a) A, C</p> <p>b) Line 3. The bread slice A is in a freezer, so it has no warmth which is needed for mould to grow as the temperature in freezer is very low, so no mould grew.</p>
Q30)	<p>a) As X has a hairy body, the pollen grain from R will stick onto its body easily and X can help transfer it from the Anther to the Stigma of a Female R flower.</p> <p>b) Animals. The fruit of R is eaten by animals and the tiny indigestible seeds will be passed out in its droppings, far away from parent plant.</p>
Q31)	<p>a) i) Oxygen</p> <p>ii) respiratory system</p> <p>b) Stomata in leaves, it also helps in exchange of gases which is the function of Z.</p>

	c) Plants need to take in gas R to photosynthesize to make food for themselves to survive.
Q32)	<p>a) 200cm^3</p> <p>b) Increase. Air has mass, even though its volume does not change, its mass increases as the air is being compressed when more gas is being added.</p> <p>c) The air in the boat will gain heat from the sun and expand and air takes up space, not enough space for air, so the boat might tear.</p>
Q33)	<p>a) Doctor John's mask taped across the nose bridge and cheek, so when he speaks, water vapour cannot escape through the nose bridge or cheeks and no warmer water vapour will touch the cooler surface of the spectacle lenses and condense and lose heat to it into water droplets. Therefore not fogging up the spectacles.</p> <p>b) The difference in temperature of surrounding air and water vapour is smaller, so the spectacle lenses gain heat from surrounding air and temperature higher than it was in the room, so when water vapour touches the cooler surface of the lenses, it loses less heat and condenses lesser, causing it to fog lesser.</p>
Q34)	<p>The diagram shows a circuit with a battery at the bottom. Three parallel branches are connected to the battery. The top branch contains a 'music box' and a bulb labeled 'bulb X'. The middle branch contains a bulb labeled 'bulb Y'. The bottom branch contains a bulb labeled 'bulb Z'. Each branch has a switch in series with the component.</p>
Q35)	a) Magnet

	<p>b) No. Silver is not a magnetic material, so it cannot be attracted by plate X which is magnetic. If it was silver, the mask would just remain on Amy's face even when Plate X is used to lift the mask.</p> <p>c) The magnet in the removal tool was weaker, so it has lesser magnetic force and removed lesser mask in the same amount of time.</p>
Q36)	<p>a) No. A and C have the same mass but different areas of contact on the ramp, but they still take the same time to reach the ground.</p> <p>b) It increases the frictional force between wheels and icy road surface, as icy road is slippery and has lesser friction, it is easy for car to slide, so snow-chained tyres increase friction between wheels and icy road to prevent car from sliding due to little friction between the wheels and the icy road.</p>
Q37)	<p>a) It changes the shape of the dough by flattening it.</p> <div style="text-align: center;"> <p>The graph has a vertical axis labeled 'gravitational force (N)' and a horizontal axis labeled 'height of dough above the ground'. A horizontal line is drawn across the graph, representing a constant gravitational force. A diagonal line starts from the horizontal line and slopes upwards to the right, indicating that as the height of the dough increases, its shape changes.</p> </div> <p>b)</p> <p>c) Tony exerted pushing force on flattened dough by tossing it into the air, the push force is greater than gravitational force pulling it down, so it was able to move up into air.</p>
Q38)	<p>a) Use a similar set-up without substance A.</p> <p>b) To ensure that other sources of light will not affect the amount of light detected by the light sensor and that all of the light detected is from the torch.</p> <p>c) Yes, changing the liquid affect the amount of light detected by light sensor.</p>
Q39)	<p>a) Place the metal lid instead of the glass jar into the hot water.</p>

	<p>ii) When you place the metal lid into the hot water, the metal lid will gain heat and expand, loosening the tight lid and hence, Ben can open the glass jar.</p> <p>c) Ice cubes Hot water</p>
Q40)	<p>a) The towel on the top of the stack will have a greater exposed surface area in contact with the cooler surrounding air compared to one of the rolled up towels on the top stack of A, thus it will lose more heat to the surrounding air, making it cooler than the rolled-up towels on the top stack of A.</p> <p>b) i) metal ii) wooden</p> <p>c) The temperature of towel A in the wooden box decreased slower. Wood is a poorer conductor of heat .</p>
Q41)	<p>a) Potential energy > Kinetic energy > Kinetic energy > electrical energy > light energy</p> <p>b) Lesser potential energy of water A, as it is at a lower position, convert into lesser kinetic energy of falling water convert into lesser kinetic energy of spinning waterwheel convert into lesser electrical energy in generator convert into lesser light energy in bulb, so bulb is dimmer.</p>