



Anglo-Chinese School  
(Primary)

A Methodist Institution  
(Founded 1886)

2023 P6 PRELIMINARY EXAM  
MATHEMATICS  
PAPER 1 (BOOKLET A)  
PRIMARY SIX

Name: \_\_\_\_\_ ( )

Class: Primary 6

Date: 21 August 2023

Duration of Booklets A & B: 1 hour

**INSTRUCTIONS TO CANDIDATES**

1. This question paper consists of 10 printed pages, including the cover page.
2. Do not turn this page until you are told to do so.
3. Follow all instructions carefully.
4. Shade your answers on the Optical Answer Sheet (OAS) provided.
5. You are not allowed to use a calculator.



Questions 1 to 10 carry 1 mark each. Questions 11 to 15 carry 2 marks each.  
For each question, four options are given. One of them is the correct answer.  
Make your choice (1, 2, 3 or 4) and shade your answer on the Optical Answer  
Sheet (OAS). (20 marks)

---

1. Which one of the following is the same as  $\frac{3}{8} \div 5$ ?

(1)  $\frac{3}{8} \times \frac{1}{5}$

(2)  $\frac{3}{8} \times 5$

(3)  $\frac{8}{3} \times \frac{1}{5}$

(4)  $\frac{8}{3} \times 5$

2. Find the sum of all the factors of 16.

(1) 30

(2) 31

(3) 34

(4) 35

3. In the figure below, AB, CD, WX and YZ are straight lines.  
Which one of the following statements is correct?

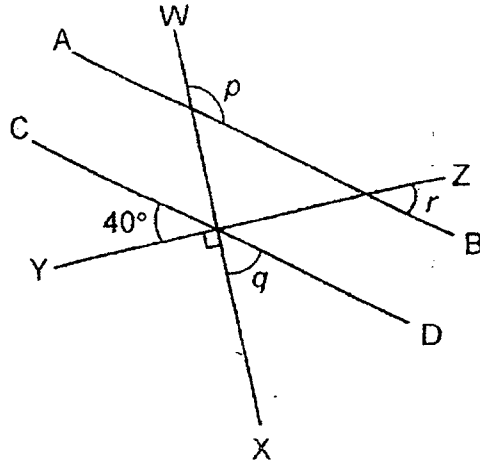

- (1)  $\angle r = \angle q$   
 (2)  $\angle q = 40^\circ$   
 (3)  $\angle p = 130^\circ$   
 (4)  $\angle p = 180^\circ - \angle r$
4. Which one of the following statements is incorrect?

- (1)  $0.25 = \frac{1}{4}$   
 (2)  $\frac{3}{8} = 0.375$   
 (3)  $\frac{1}{9}$  is more than 0.12  
 (4)  $\frac{144}{11}$  is more than 13.

5. The figure below shows a solid.

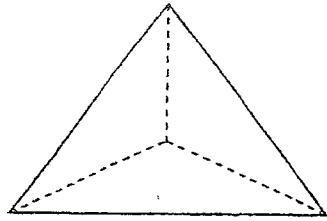

Which one of the following is a net of the solid?

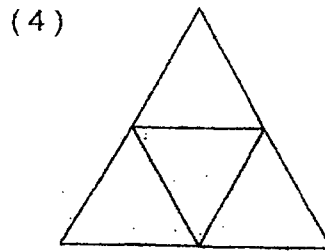
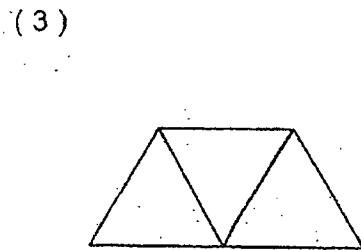
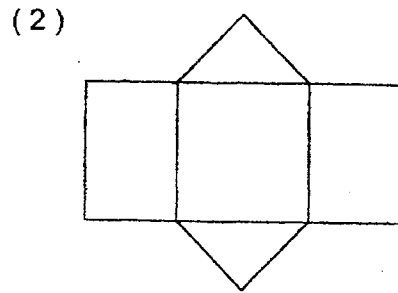
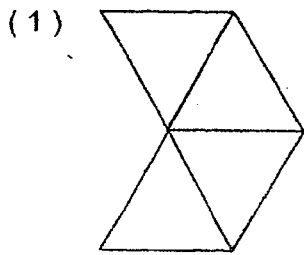

6. Which one of the following is most likely the mass of a laptop?

- (1) 2.095 g
- (2) 2.95 kg
- (3) 20.95 kg
- (4) 29.5 g

7. The figure below shows a rectangular tank containing  $1500 \text{ cm}^3$  of water. Find the height of the water level in the tank.

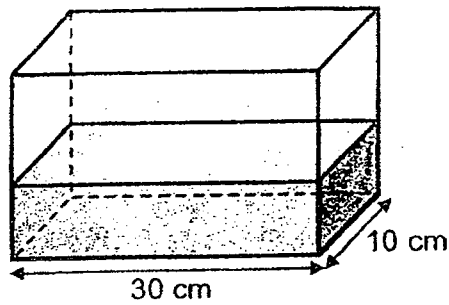

- (1) 0.005 m
- (2) 0.05 m
- (3) 0.5 m
- (4) 5 m

8. Mingfa took 20 minutes to travel from City A to City B. His average speed was 66 km/h. Find the distance between the two cities.
- (1) 22 km
  - (2) 44 km
  - (3) 198 km
  - (4) 1320 km
9. The average allowance of 3 siblings is \$34. The eldest sibling received \$50. The other two siblings received the same amount of money. How much did each of the other two siblings receive?
- (1) \$18
  - (2) \$25
  - (3) \$26
  - (4) \$52

10. The following pie chart shows the number of tickets sold on a certain day. The total number of tickets sold on that day was 860. Find the number of student tickets sold on that day.

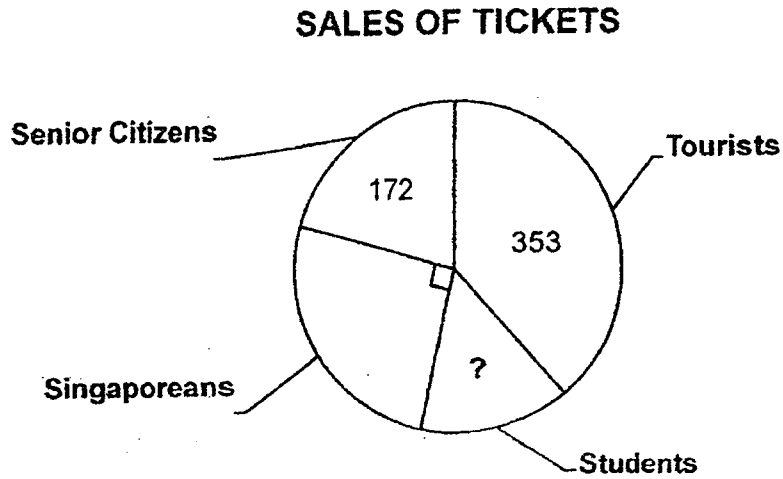





- (1) 120
- (2) 215
- (3) 335
- (4) 525

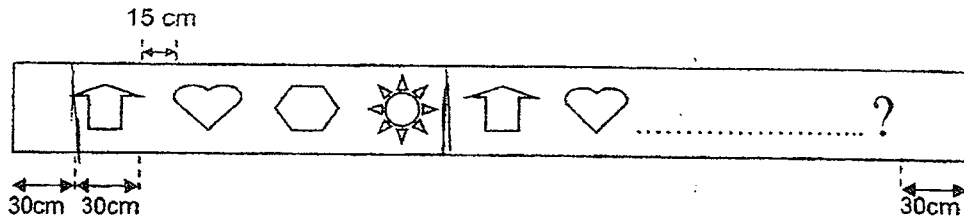

11. Renee uses four different shapes to design a 6 m 30 cm long banner. She leaves a space of 30 cm at each end of the banner. The width for each shape is 30 cm. There is an interval of 15 cm between every shape. There is no interval after the last shape.



Which one of the following will be the last shape placed on the banner?

- (1) 
- (2) 
- (3) 
- (4) 
12. The doctor prescribed 30 ml of fever syrup for Chris. He had to take 5 ml of the fever syrup every 3 hour. He first took his fever syrup at 4 a.m. When would his last intake be?

- (1) 4 p.m.
- (2) 6 p.m.
- (3) 7 p.m.
- (4) 10 p.m.

13. A packet of chocolates contains pieces of milk, dark and orange chocolates. 25% of the chocolates are dark chocolates. The ratio of the number of dark chocolates to the number of milk chocolates is 5 : 7. There are 78 pieces of dark and orange chocolates. What is the total number of pieces of chocolates in the packet?

- (1) 104  
 (2) 120  
 (3) 130  
 (4) 195

14. The figure below is made up of 8 identical rectangles. Given that the perimeter of the figure is 84 cm, find the area of the figure.

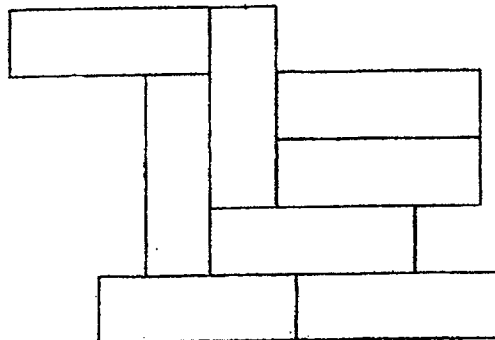

- (1) 147 cm<sup>2</sup>  
 (2) 192 cm<sup>2</sup>  
 (3) 216 cm<sup>2</sup>  
 (4) 294 cm<sup>2</sup>

15. The figures below are made up of identical squares.

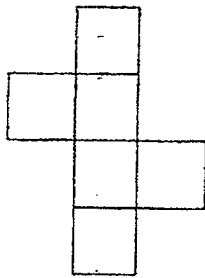

Figure 1

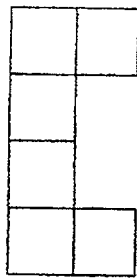

Figure 2

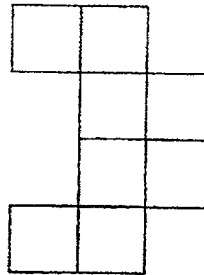

Figure 3

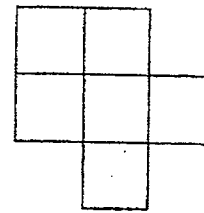

Figure 4

How many figure(s) is/are symmetrical?

- (1) 1
- (2) 2
- (3) 3
- (4) 4

END OF BOOKLET A





Anglo-Chinese School  
(Primary)

A Methodist Institution  
(Founded 1886)

2023 P6 PRELIMINARY EXAM  
MATHEMATICS  
PAPER 1 (BOOKLET B)  
PRIMARY SIX

N: \_\_\_\_\_ ( ) Class: Primary 6 \_

Date: 21 August 2023

Duration of Paper Booklets A & B: 1 hour

\_\_\_\_\_  
Parent's/Guardian's signature

**INSTRUCTIONS TO CANDIDATES**

1. This question paper consists of 12 printed pages, including the cover page.
2. Do not turn this page until you are told to do so.
3. Follow all instructions carefully.
4. Answer all questions.
5. Use a dark blue or black ballpoint pen to write your answers in the space provided for each question.
6. Do not use correction fluid/tape or highlighters.
5. You are not allowed to use a calculator.

Paper 1 Booklet A. Multiple-Choice Questions	20	
Paper 1 Booklet B. Short Answers: Part 1	5	
Paper 1 Booklet B. Short Answers: Part 2	20	
Total Marks	45	



Questions 16 to 20 carry 1 mark each. Write your answers in the spaces provided.  
For questions which require units, give your answers in the units stated.

(5 marks)

---

16. Write  $4 + \frac{3}{10} + \frac{215}{1000}$  as a decimal.

Answer : \_\_\_\_\_

17. Find the value of  $68 - 12 \div 2 + 11$ .

Answer : \_\_\_\_\_

1

Sub-Total :

18. The solid below is made up of 1-cm cubes. What is the least number of cubes that needs to be added to the solid to make it a cube?

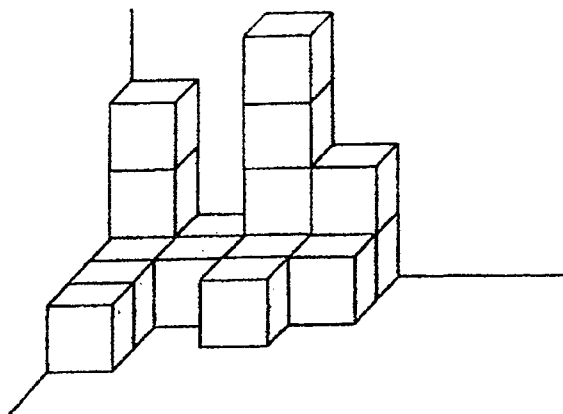

Answer : \_\_\_\_\_

19. Lindy used  $\frac{2}{5}$  m of ribbon to make bow. She made a total of 25 bows.  
How many centimetres of ribbon did she use in all?

Answer : \_\_\_\_\_ cm

2

Sub-Total :



20. Mr Kumar drove for 6 h 15 min from his house to Green Valley Shopping Mall. He spent 2 h 45 min at the mall and left the mall at 5 p.m. What time did he start driving from his house?

Answer : \_\_\_\_\_

Questions 21 to 30 carry 2 marks each. Show your working clearly and write your answers in the spaces provided. For questions which require units, give your answers in the units stated. (20 marks)

21. In the figure below, PQ and QR are drawn to scale.

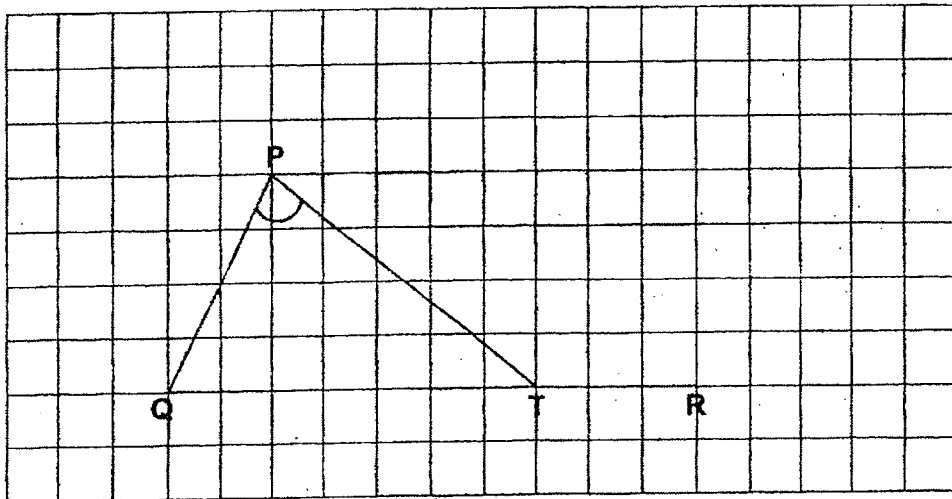

- (a) Draw 2 lines, PS and SR so that PQRS is a parallelogram. [1]
- (b) Measure  $\angle QPT$ . [1]

Answer : (b) \_\_\_\_\_°

22. Paul is at Point X and he is facing North-West. Which point will Paul be facing after turning 90° anti-clockwise?

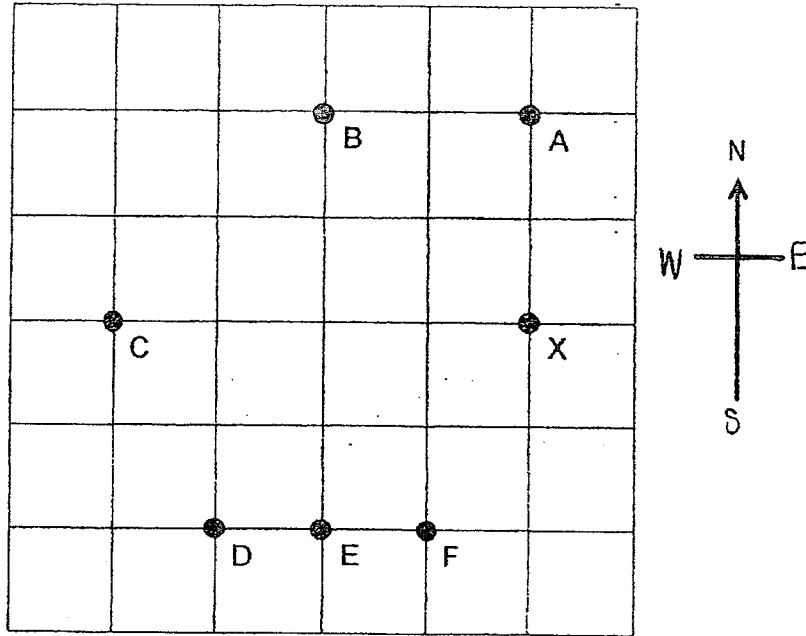

Answer : Point \_\_\_\_\_

23. Find the value of  $103 - 3m \times \frac{2m}{3}$  when  $m = 6$ .

Answer : \_\_\_\_\_

24. The diagram below is only half a symmetrical figure. Complete the figure.

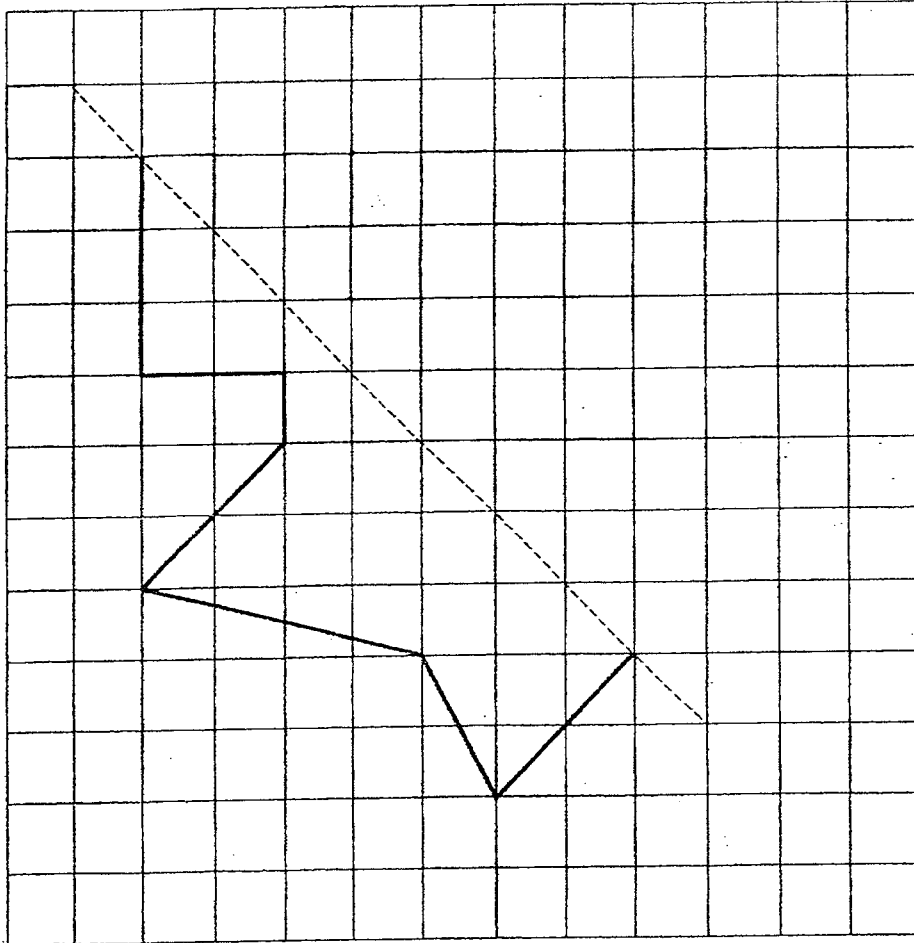

25. Numbers are arranged in columns as shown.  
In which column will the number 100 appear?

A	B	C	D	E	F
		1	2	3	4
5	6	7	8	9	10
11	12	13	14	15	16
17	18	19	20	21	22
.	.	.	.	.	.
.	.	.	.	.	.
.	.	.	.	.	.

Answer : Column \_\_\_\_\_

26. The sum of three numbers is 60. If the second number is  $\frac{1}{6}$  of the first number and the third number is 3 times the second number, find the first number.

Answer : \_\_\_\_\_

7

Sub-Total :

27. The figure below is made up of a rectangle, a circle and 2 identical semicircles. The diameters of the circle and the semicircles are 14 cm. Find the total area of the shaded parts. (Take  $\pi = \frac{22}{7}$ )

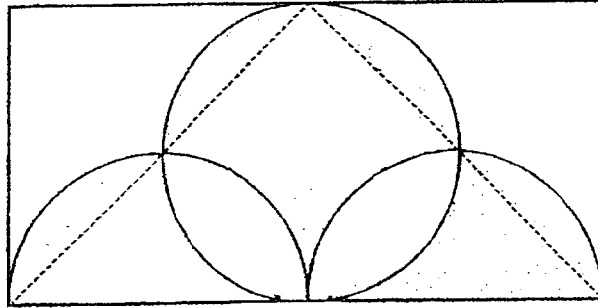

Answer: \_\_\_\_\_ cm<sup>2</sup>

8

Sub-Total :

28. The bar graph below shows the number of cups of ice-cream sold at a stall.  
 What percentage of the cups of ice-cream sold were lemon flavour?  
 Give your answer correct to 1 decimal place.

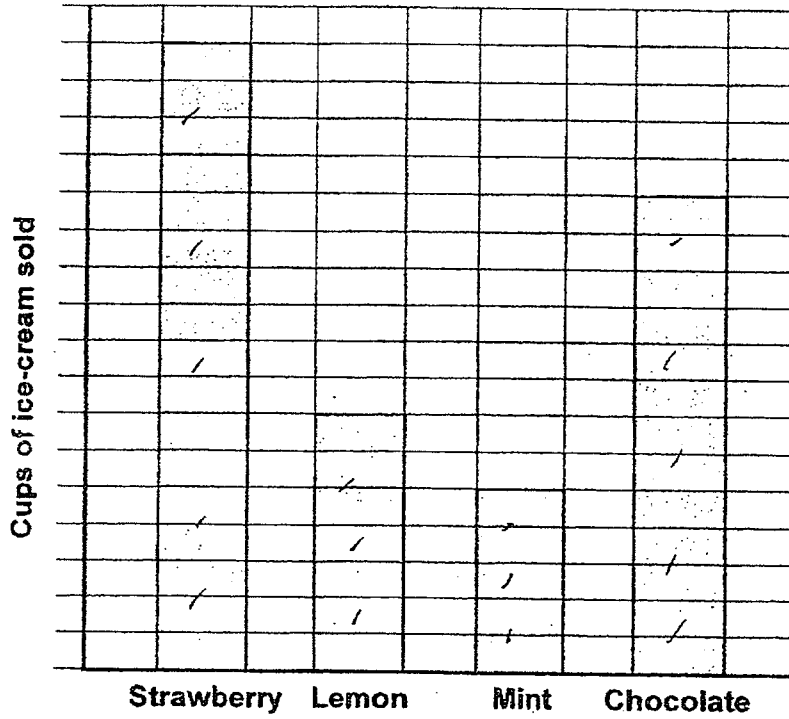

Answer : \_\_\_\_\_ %

Sub-Total :

29. There are 30 boys and girls in a group. The average height of the children is 145 cm. When 3 more boys joined the group, the average height of each student increased by 0.5 cm. The total height of the girls in the group is 1820 cm.

Each of the statements below is either true, false or not possible to tell from the information given. For each statement, put a tick ( ✓ ) to indicate your answer.

Statement	True	False	Not possible to tell
The average height of the 3 boys who joined the group is 150.5 cm.			
The average height of all the boys before the 3 boys joined the group is greater than 145 cm.			



30. The ratio of the amount of money Amil had to the amount of money Bala had to the amount of money Charles had was 8 : 3 : 5. After they each spent the same amount of money, Amil had \$66 left. The amount of money Charles had left was 5 times that of Bala. Find the total amount of money the 3 children had at first.

Answer : \$ \_\_\_\_\_

**END OF BOOKLET B**





Anglo-Chinese School  
(Primary)

A Methodist Institution  
(Founded 1886)

2023 P6 PRELIMINARY EXAM  
MATHEMATICS  
PAPER 2  
PRIMARY SIX

Name: \_\_\_\_\_ ( ) Class: Primary 6 \_\_\_\_\_

Date: 21 August 2023

Duration of Paper 2: 1 hour 30 minutes

\_\_\_\_\_  
Parent's/Guardian's signature

**INSTRUCTIONS TO CANDIDATES**

1. This question paper consists of 16 printed pages, including the cover page.
2. Do not turn this page until you are told to do so.
3. Follow all instructions carefully.
4. Answer all questions.
5. Use a dark blue or black ballpoint pen to write your answers in the space provided for each question.
6. Do not use correction fluid/tape or highlighters.
7. You are allowed to use a calculator.

Section 2		
Paper 2 Section A. Short Answers	10	
Paper 2 Section B. Problem Sums	45	
<b>Total Marks</b>	<b>55</b>	



Questions 1 to 5 carry 2 marks each. Show your working clearly in the space provided for each question and write your answers in the spaces provided. For questions which require units, give your answers in the units stated. (10 marks)

Do not  
write  
this s

1. The cost of 3 chairs and 5 tables is \$360. The cost of 6 chairs and 15 tables is \$900. What is the cost of 1 table? (Round off the answer to the nearest \$10.)

Answer: \$ \_\_\_\_\_ [2]

2. ABCD is a rhombus.  $\angle BAC = 51^\circ$ . What is the sum of  $\angle x$  and  $\angle y$ ?

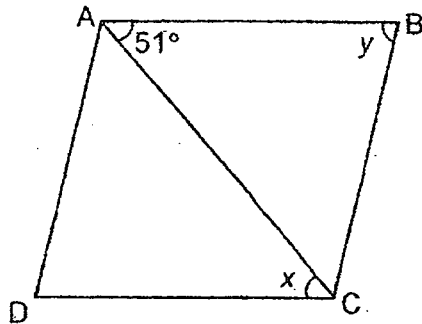

Answer: \_\_\_\_\_ ° [2]

3. A tank contained 6ℓ of water. The graph below shows the amount of water left in a tank at the end of each day. What is the total amount of water used on Day 2 and Day 4?

Do not  
write in  
this space

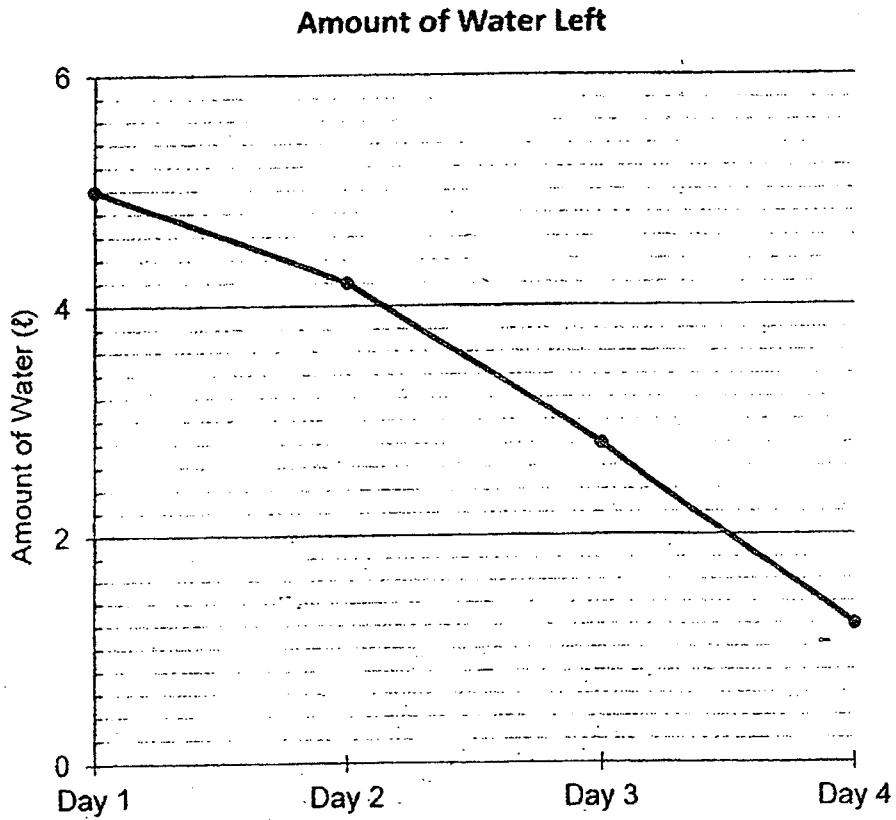

Answer: \_\_\_\_\_ ℓ. [2]



4. Mrs Lim bought a watch at a discount of 15% and she paid \$124.10, not including GST. What is the original price of the watch including 8% GST?

Do not write in this space

Answer: \$ \_\_\_\_\_ [ 2 ]

5. Mrs Sim bought a bag for \$140. She paid the cashier in \$10 and \$5 notes. If there were fifteen notes altogether, how many \$10 notes were there?

Answer: \_\_\_\_\_ [ 2 ]

For questions 6 to 17, show your working clearly in the space provided for each question and write your answers in the spaces provided. The number of marks available is shown in brackets [ ] at the end of each question or part-question.

Do not write in this space

(45 marks)

6. The figure below is formed by joining five identical  $\frac{3}{4}$ -circle discs. Points A, B, C, D and E are centres of each  $\frac{3}{4}$ -circle disc. Given that the distance between B and D is 17 cm and the distance between the first and the last disc is 48 cm, find the length AB.

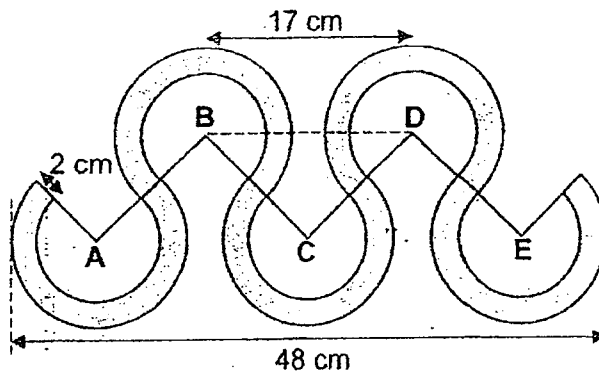

Answer: \_\_\_\_\_ [3]





7. Serena has a monthly salary of \$8650. She spent  $\frac{1}{5}$  of her money on food. The pie chart below shows how she used her monthly salary.

Do not  
write in  
this space

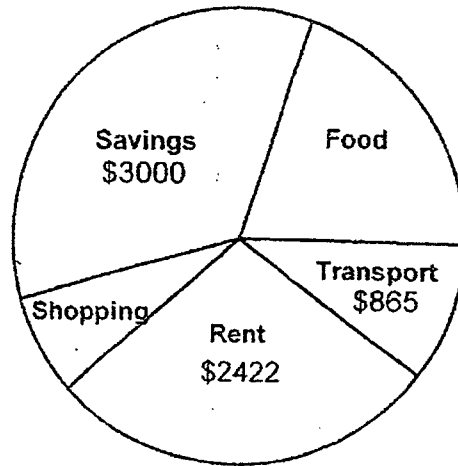

- (a) How much money did Serena spend on food?

Answer: (a) \_\_\_\_\_ [ 1 ]

- (b) What fraction of her salary did Serena spend on rent and transport?

Answer: (b) \_\_\_\_\_ [ 1 ]

- (c) What percentage of her salary did she spend on shopping?  
Give your answer correct to nearest 1%.

Answer: (c) \_\_\_\_\_ [ 1 ]



Do not  
write in  
this space

8. The figure below is not drawn to scale. ABEF is a parallelogram and BCDE is a trapezium.  $BE \parallel CD$ ,  $AB \parallel FD$  and  $BC \parallel AD$ . DF is a straight line.  
 $\angle ADF = 42^\circ$  and  $\angle DAF = 68^\circ$ .

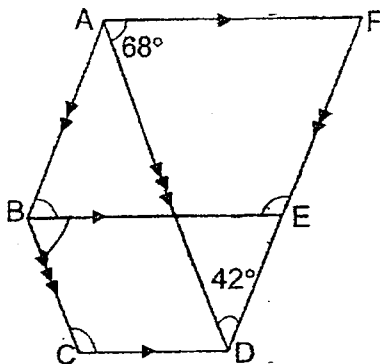

- (a) Find  $\angle BCD$ .

Answer: (a) \_\_\_\_\_ [1]

- (b) Find  $\angle ABE$ .

Answer: (b) \_\_\_\_\_ [1]

- (c) Find  $\angle BEF$ .

Answer: (c) \_\_\_\_\_ [1]



9. The distance between Town A and Town B is 1260 km. Train X travels from Town A to Town B at 8.00 a.m. at an average speed of 230 km/h. At the same time, Train Y travels from Town B to Town A at an average speed of 190 km/h.

Do not  
write in  
this space

- (a) What time did they meet?

Answer: (a) \_\_\_\_\_ [ 1 ]

- (b) How far would each train have travelled when they meet on the way?

(b) Train X: \_\_\_\_\_ [ 1 ]

Train Y: \_\_\_\_\_ [ 1 ]



10. The following table shows the charges for making an overseas call to Australia.

Overseas Call Charges	
First 15 minutes	\$2.60
Every additional minute	$p$ ¢ per minute

Do not  
write in  
this space

- (a) Mrs Jamus paid \$32 for a phone call to her sister in Australia. What was the duration of the call? Leave your answer in terms of  $p$ .

Answer: (a) \_\_\_\_\_ [ 2 ]

- (b) Given that  $p = 60$ , find the duration of the call Mrs Jamus made.

Answer: (b) \_\_\_\_\_ [ 1 ]



11. Bottles A, B and C contain 7.35 litres of oil altogether.  $\frac{1}{5}$  of the oil in Bottle A is transferred to Bottle B. After that,  $\frac{1}{5}$  of the oil in Bottle B is transferred to Bottle C. Now, Bottle A has twice the amount of oil in Bottle B and Bottle B has twice the amount of oil in Bottle C.

Do not  
write in  
this space

- (a) How much oil was transferred from Bottle A to Bottle B?

Answer: (a) \_\_\_\_\_ [2]

- (b) How much oil was in Bottle C at first?

Answer: (b) \_\_\_\_\_ [2]



12. Marcus is playing a video game. On his first win, he obtains 3 points. For every subsequent win, he will receive 2 additional points more than his previous win.

Do not  
write in  
this space

- (a) Marcus gets 6 wins in a row. What will be his score for the 6th win?

Answer: (a) \_\_\_\_\_ [ 2 ]

- (b) How many times must he win the game in a row for him to achieve 99 points?

Answer: (b) \_\_\_\_\_ [ 2 ]



13. The figure below is made up of four squares of sides 10 cm, four quadrants and eight semicircles. Find the total area of the shaded parts.

(Take  $\pi = 3.14$ )

Do not write in this space

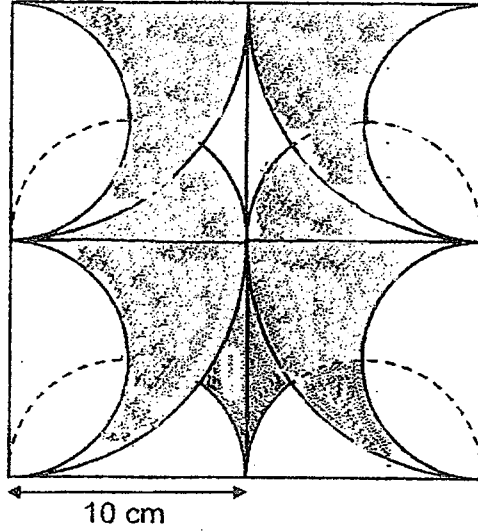

Answer: \_\_\_\_\_ [5]



14. The container shown below is made up of 2 cuboids and a 6-cm cube. The small cuboid has a square base of side 3 cm. The dimension of the big cuboid is 16 cm by 9 cm by 5 cm. There is 864 ml of water in the container and the height of the water level in the small cuboid and the cube is the same. What is the height of the water level from the base of the container?

Do not write in this space

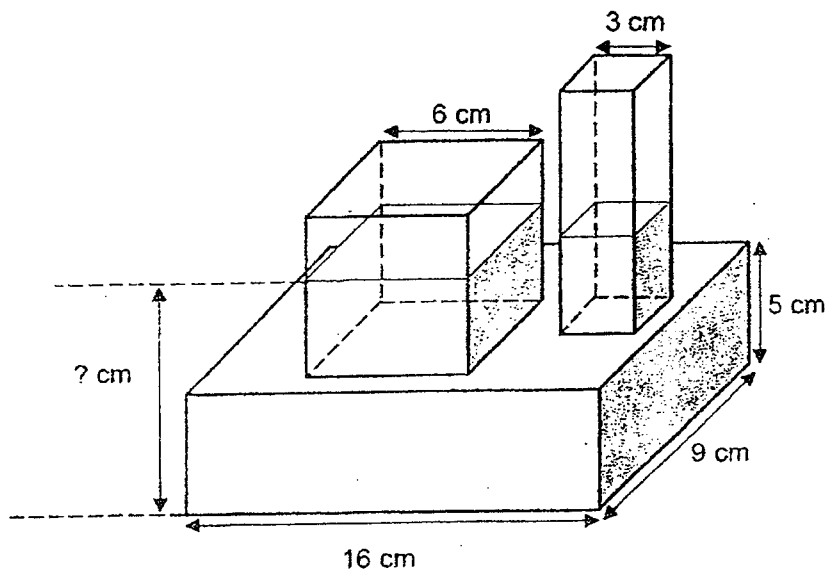

Answer: \_\_\_\_\_ [4]





15. Simon, Marc and Wilson sat for their Math exam. The average score of Simon and Marc was 85 marks. The average score of Marc and Wilson was 91 marks. The average score of Simon and Wilson was 82 marks.

Do not  
write in  
this space

- (a) What was the average mark of the three boys?

(a) \_\_\_\_\_ [2]

- (b) Simon's mark was recorded incorrectly. He was given an additional of 7.5 marks. What is the correct average score of the 3 boys?

Answer: (b) \_\_\_\_\_ [2]



16. The figure below is not drawn to scale. ABE is an equilateral triangle and BCD is an isosceles triangle. ABC and BDF are straight lines and  $AC \parallel EF$ .  $\angle EBD = 90^\circ$  and  $\angle BED = 43^\circ$ .

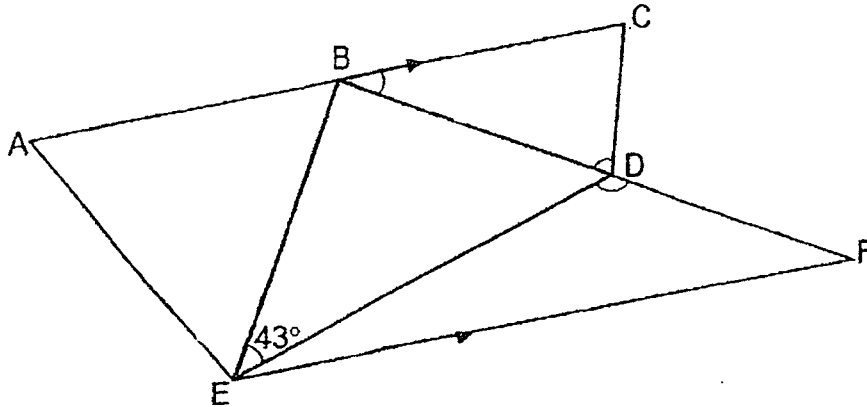

- (a) Find  $\angle CBF$ .

Answer: (a) \_\_\_\_\_ [2]

- (b) Find  $\angle BDC$ .

Answer: (b) \_\_\_\_\_ [1]

- (c) Find  $\angle EDF$ .

Answer: (c) \_\_\_\_\_ [2]

Do not  
write in  
this space



17. A box contained some twenty-cent, fifty-cent and one-dollar coins. 24% of the coins are twenty-cent coins. The ratio of the number of fifty-cent coins to the number of one-dollar coins is 7 : 12. When 62.5% of the twenty-cent coins were removed, the total number of coins decreased by 15%. In the end there were 255 coins left.

Do not  
write in  
this space

- (a) How many twenty-cent coins were removed?

Answer: (a) \_\_\_\_\_ [2]

- (b) How many one-dollar coins were there in the box?

Answer: (b) \_\_\_\_\_ [2]



END OF PAPER 2



YEAR : 2023  
 LEVEL : PRIMARY 6  
 SCHOOL : ANGLO-CHINESE SCHOOL (PRIMARY)  
 SUBJECT : MATHEMATICS  
 TERM. : PRELIMINARY EXAMINATION

**(BOOKLET A)**

Q1	1	Q2	2	Q3	3	Q4	3	Q5	4
Q6	2	Q7	2	Q8	1	Q9	3	Q10	1
Q11	1	Q12	3	Q13	2	Q14	3	Q15	3

**(BOOKLET B)**

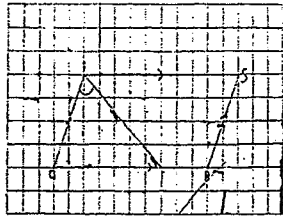
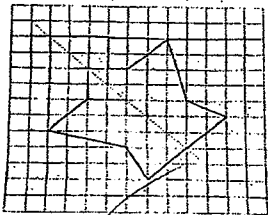
Q16	$4 + \frac{3}{10} + \frac{215}{1000}$ $= 4.515$
Q17	$68 - 12 \div 2 + 11 = 73$
Q18	$4 \times 4 \times 4 = 64$ $64 - 11 - 3 - 2 = 47$
Q19	$25 \times \frac{2}{5} = 10$ $10\text{m} = 1000\text{cm}$
Q20	8 a.m.
Q21	(a)  (b) $78^\circ$
Q22	Point E
Q23	$103 - 3 \times 6 - \frac{12}{3} = 31$
Q24	
Q25	Column F
Q26	36
Q27	$\frac{1}{2} \times 28 \times 14 = 196\text{cm}^2$
Q28	$17 + 7 + 5 + 13 = 42$ $\frac{7}{42} \times 100\% \approx 16.7\%$

Q29	$145 \times 33 = 4801.5$ $145 \times 30 = 4350$ $(4801.5 - 4350) \div 3 = 150.5$ (True $\checkmark$ , (No. possible to tell))
Q30	A:B:C 8:3:5 16:6:10 $16 - 5 = 11$ $11u \rightarrow \$6$ $16 + 6 + 10 = 32$ $32u \rightarrow \$192$

**PAPER 2**

Q1	3 chairs + 5 tables $\rightarrow$ \$360 6 chairs + 10 tables $\rightarrow$ \$720 5 tables $\rightarrow$ $900 - 720 = \$180$ 1 table $\rightarrow$ \$40	
Q2	$180 - (51 \times 2) = 78$ $51 + 78 = 129^\circ$	
Q3	$800 + 1600 = 2400$ $2400\text{ml} = 2.4\text{L}$	
Q4	$\$124.10 \div 17 \times 20 = \$146$ $\frac{108}{100} \times \$146 = \$157.68$	
Q5	13 (\$10) 2 (\$5) Total \$140 $140 - 75 = 65$ $65 \div 5 = 13$	
Q6	$48 - 17 - 17 = 14$ $14 \div 7 = 7$ Radius = $15.5 - 7 = 8.5$ AB : $7 + 7 - 2 = 12\text{cm}$	
Q7	(a)	$\frac{1}{5} \times \$8650$ $= \$17330$
	(c)	$8650 - 3000 - 1730 - 865 - 2422$ $= 633$ $\frac{633}{8650} \times 100\% = 7\%$
Q8	(a)	$180 - 68 = 112^\circ$
	(c)	$180 - 70 = 110$
Q9	$250 + 190 = 420$ $1260 \div 420 = 3 \text{ hr}$ 8am $\rightarrow$ 11 am Ans: 11 a.m.	

(b) Train X = 690 km  
Train Y = 570 km

Q10	(a)	$(15\frac{2940}{p})\text{min}$	(b)	64min
Q11	(a)	A:B:C 4:2:1 20:10:5 $20 + 10 + 5 = 35$ $35u : 7.35$ $1u : 0.21$ $\frac{4}{5} : 20$ $\frac{1}{5} : 5$ $0.21 \times 5 = 1.05\text{l}$	(b)	$2.1 \div 4 = 0.525$ $1.05 - 0.525 = 0.525\text{l}$
Q12	(a)	$6 \times 2 + 1 =$ 13	(b)	$99 - 1 = 98$ $98 \div 2 = 49$
Q13		$5 \times 10 - \frac{1}{2} \times 3.14 \times 5 \times 5 = 10.75$ $10.75 \times 2 = 21.5$ $21.5 + 10 \times 10 = 121.5$ $\frac{1}{2} \times 3.14 \times 10 \times 10 = 78.5$ $121.50 + 78.5 = 200\text{cm}^2$		
Q14		$16 \times 9 \times 5 = 720$ $864 - 720 = 144$ $6 \times 6 + 3 \times 3 = 45$ $144 \div 45 = 3.2$ $3.2 + 5 = 8.2\text{cm}$		
Q15	(a)	Total (5 + M) $\rightarrow 85 \times 2 = 170$ Total : $91 \times 2 = 182$ total : $82 \times 2 = 164$ $170 + 164 + 182 = 516$ $516 \div 2 = 258$ $258 \div 86$	(b)	$258 - 7.5 = 250.5$ $250.5 \div 3 = 83.5$
Q16	(a)	$180 - 90 - 60 = 30^\circ$	(b)	$(180 - 30) \div 2 = 75^\circ$
	(c)	$90 + 30 = 120$ $180 - 120 - 43 = 17$ $180 - 90 - 43 - 17 = 30$ $180 - 17 - 30 = 133^\circ$		
Q17	(a)	$20\text{¢} : 50\text{¢} + \$1$ 6 : 19 24 : 76 (100) $50\text{¢} : \$1$ 7:12 28 : 48 $\frac{5}{8} \times 24 = 15$ $85u : 255$ $1u : 3$ $15u : 45$	(b)	$48u : 3 \times 48 = 144$

