



NANYANG PRIMARY SCHOOL
PRIMARY 6 SCIENCE
CONTINUAL ASSESSMENT 1
2019

BOOKLET A

Date : 6 March 2019

Duration : 1 h 45 min

Name : _____ ()

Class: Primary 6 ()

**DO NOT OPEN THIS BOOKLET UNTIL YOU ARE TOLD TO DO SO.
FOLLOW ALL INSTRUCTIONS CAREFULLY.**

Booklet A consists of 21 printed pages including this cover page.

Section A (56 marks)

For each question from 1 to 28, four options are given. One of them is the correct answer. Indicate your choice in this booklet and shade the correct oval (1, 2, 3 or 4) on the Optical Answer Sheet provided.

1. The diagram below shows the human digestive system.

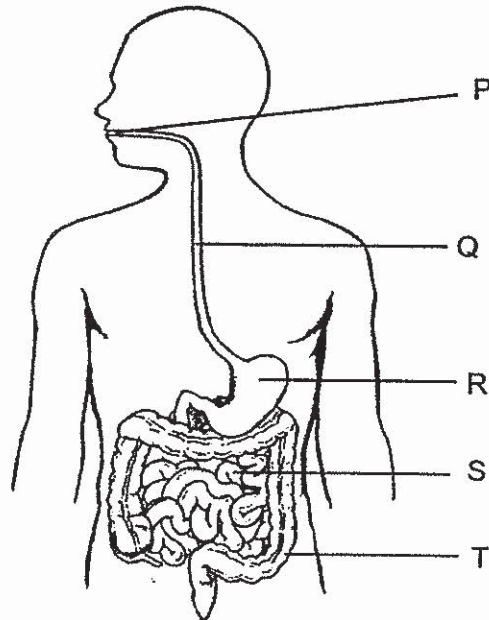

Which of the following statements about the digestive system are correct?

- A Digestion is completed at part S.
- B Digestion is not carried out by parts Q and T.
- C Digested food is absorbed into the bloodstream at part T
- D Food is broken down into simpler substances at parts P and R.

- (1) A and C only
- (3) A, B and D only

- (2) B and D only
- (4) A, B, C and D

2. James wanted to investigate how the number of leaves affect the amount of water taken in by a plant. He was given 4 set-ups, P, Q, R and S. The table below shows the different conditions in each set-up at the start of his experiment.

	Set-ups			
	P	Q	R	S
Number of leaves	12	12	12	8
Number of roots	8	8	12	8
Volume of water (ml)	200	100	200	200
Temperature of water (°C)	30	30	25	30
Layer of oil on the surface of the water	Yes	Yes	No	Yes

Which 2 set-ups should he use to ensure a fair test?

- (1) P and Q
- (2) P and S
- (3) Q and R
- (4) R and S

3. Which of the following statement(s) about photosynthesis is/are correct?

- A Photosynthesis breaks down food to release energy.
- B Food made during photosynthesis is used by the plant.
- C Photosynthesis takes place only in cells with chloroplast.

- (1) A only
- (2) A and B only
- (3) A and C only
- (4) B and C only

4. The diagram below shows how energy from the Sun is passed on to living things, P, Q and R.

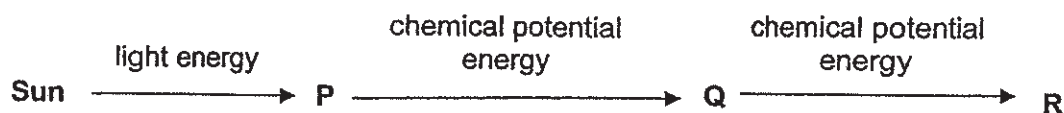

Based on the information above, which one of the following sentences is correct?

- (1) Energy in P is stored as starch.
- (2) R gets its energy directly from P.
- (3) Q gets its energy indirectly from P.
- (4) P is the main source of heat and light energy.

5. Su Ling carried out an experiment using some water snails and hydrilla plants. Water with the same amount of dissolved carbon dioxide was used to set up the experiment as shown in the diagram below. A stopper was placed at the top of each set-up.

Set-up A and set-up B were left in the sun for 2 hours while set-up C was placed in a black box for the same duration of time.

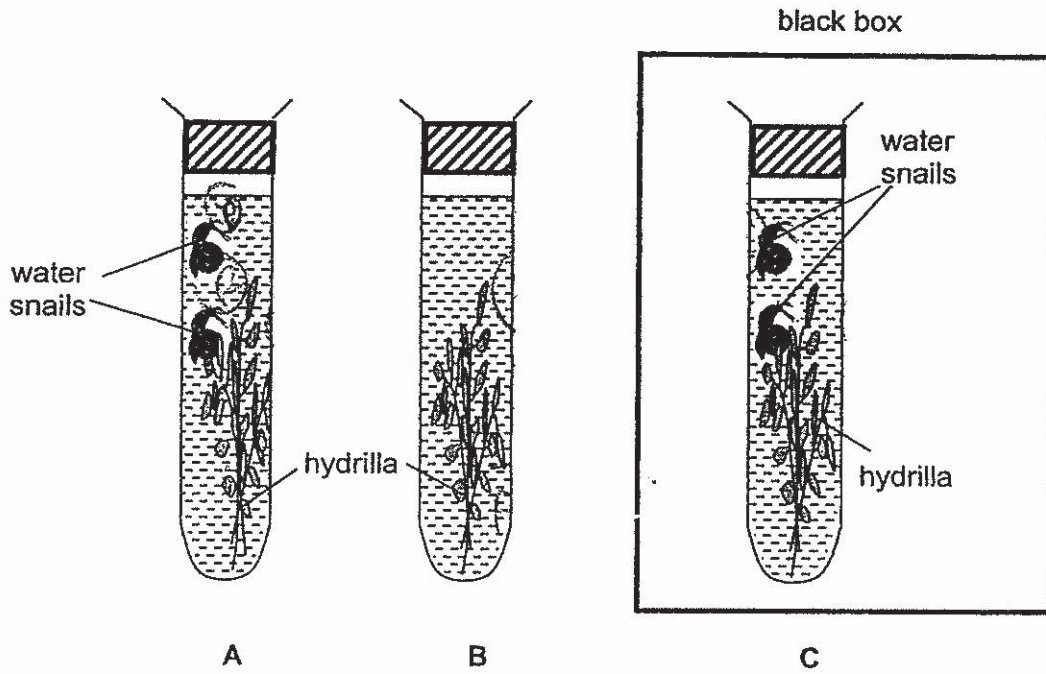

At the end of the experiment, Su Ling measured the amount of carbon dioxide in each set-up again.

Arrange set-ups, A, B and C, according to the amount of carbon dioxide left in each set-up.

	Lowest amount of carbon dioxide	→	Highest amount of carbon dioxide
(1)	A	B	C
(2)	B	A	C
(3)	B	C	A
(4)	C	A	B

6. In the presence of light, plants are able to photosynthesise.

Which one of the following correctly states what is taken in and produced during this process?

	Gas released	Gas taken in	Produced by the leaf	Taken in by the roots
(1)	oxygen	carbon dioxide	sugar	water
(2)	carbon dioxide	oxygen	sugar	water
(3)	oxygen	carbon dioxide	water	mineral salts
(4)	carbon dioxide	oxygen	water	mineral salts

7. Luke placed a plant in the dark for 12 hours. The next morning, he used the plant and set up his experiment as shown in the diagram below.

Leaves A, B, C and D were each wrapped with a clear plastic bag as shown below. Each bag contains different substances as stated in the table.

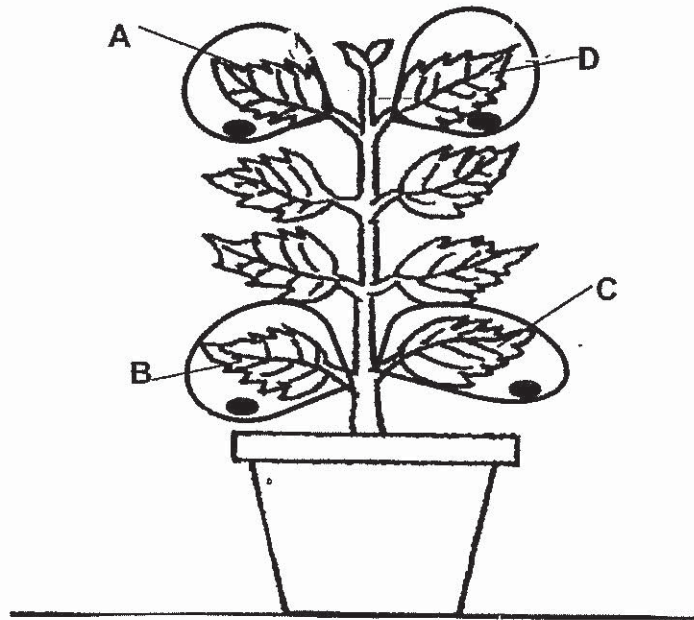

Leaf	Content in clear plastic bag
A	Substance that absorbs water
B	Substance that absorbs oxygen
C	Substance that absorbs carbon dioxide
D	Substance that produces carbon dioxide

Luke then left the plant in the sun for 12 hours before plucking the leaves, A, B, C and D, and conducted a starch test on them.

Which one of the following shows the results of the starch test?

	Starch present	Starch absent
(1)	A, D	B, C
(2)	B, C	A, D
(3)	A, B, C	D
(4)	A, B, D	C

8. Which of the following ways help to conserve water?

- A Taking shorter showers.
- B Fixing water pipes that are leaking.
- C Switching off the lights when not in use.
- D Re-using water from washing vegetables to water the plants.

- (1) A and B only
- (3) A, B and D only

- (2) C and D only
- (4) A, B, C and D

9. The diagram below represents the water cycle.

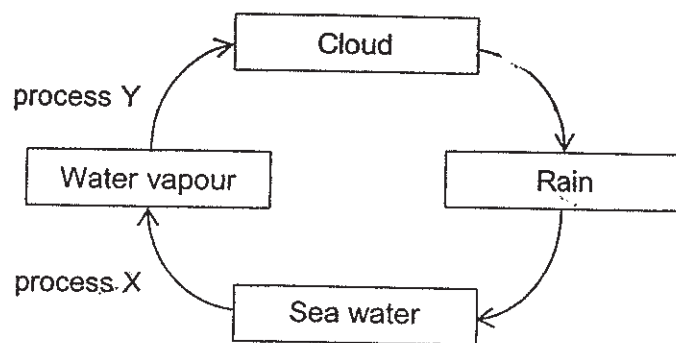

Which of the following statement(s) about the water cycle is/are correct?

- A Sea water loses heat during process X.
- B Water vapour gains heat during process Y.
- C Water vapour changes its state during process Y.

- (1) C only
- (3) B and C only

- (2) A and B only
- (4) A, B, and C

10. Tom placed a thermometer into a beaker of crushed ice. He then heated the beaker of crushed ice for some time and recorded the change in temperature in the graph below.

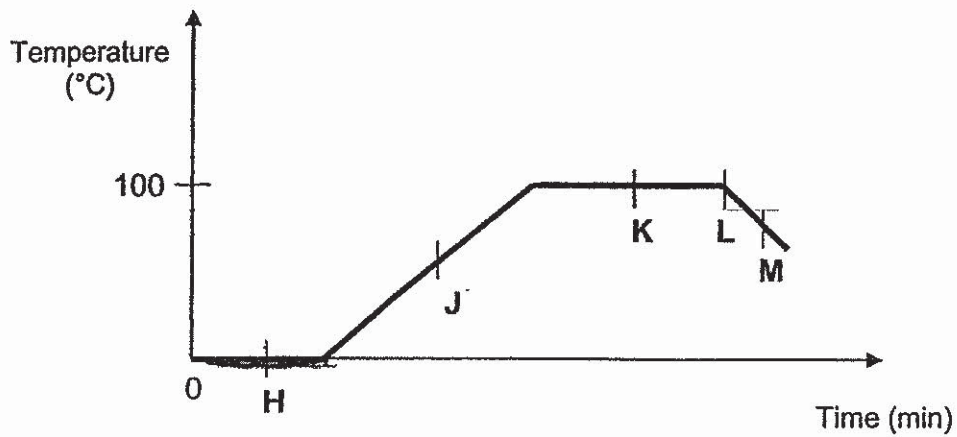

Based on the graph above, which of the following statements are true?

- A Steam was formed at point M.
- B The heat source was removed at point L.
- C Water can be observed in the beaker at point H.
- D Evaporation is taking place at points J and K only.

- (1) B and C only
- (2) A and D only
- (3) B, C and D only
- (4) A, B, C and D

11. Bala set up an experiment as shown below. He left the set-ups in a classroom at 28°C for 30 minutes and observed the readings on the weighing scales throughout the experiment.

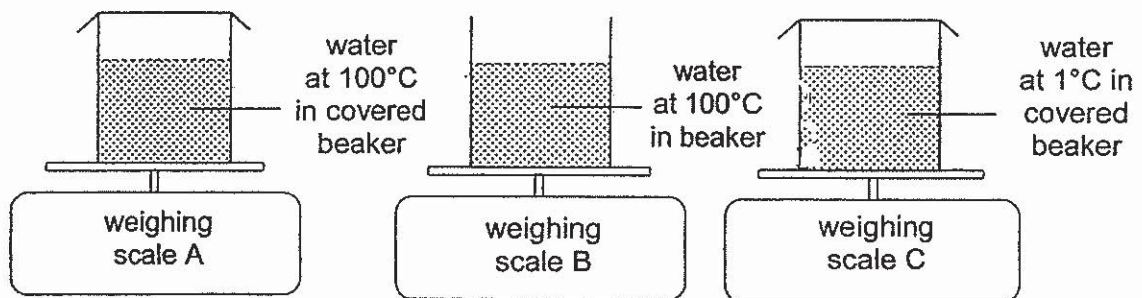

Which one of the following shows the most likely readings on the weighing scales after 30 minutes compared to the start of the experiment?

	A	B	C
(1)	Increase	Decrease	Increase
(2)	Remain the same	Decrease	Increase
(3)	Remain the same	Decrease	Remain the same
(4)	Decrease	Increase	Decrease

12. Sam set up the experiment as shown in the diagram below and placed it under a light source for 30 minutes.

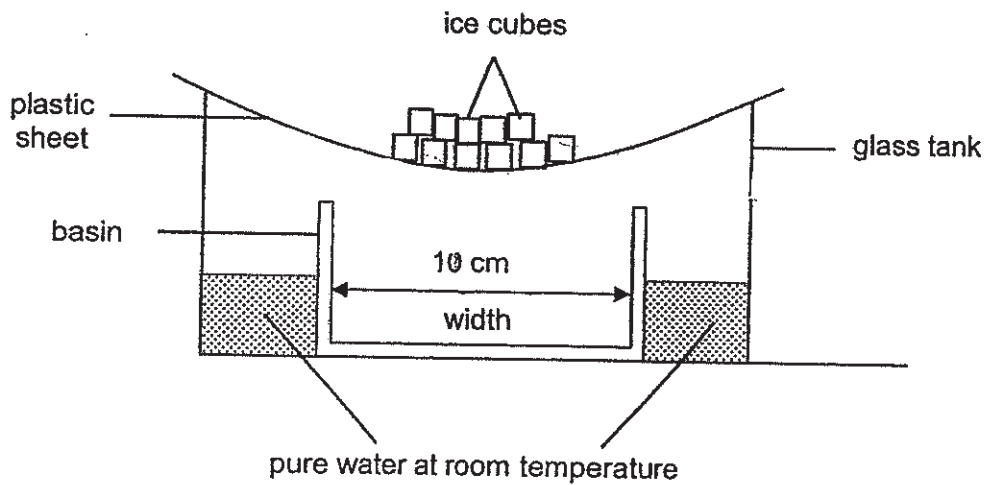

He decided to make one change to the set-up and repeated the experiment again for the same duration of 30 minutes.

Which of the following are the possible changes that he could have made and the most likely observed results?

	Change made to the set-up	Observed results
A	Replace pure water with saltwater.	Pure water will be collected in the basin
B	Use a basin with a width of 5 cm.	More pure water will be collected in the basin.
C	Fill more pure water into the glass tank at the start of the experiment.	More pure water will be collected in the basin.

- (1) A only
 (3) A and C only

13. Eddie created a jumping frog toy using the following items.

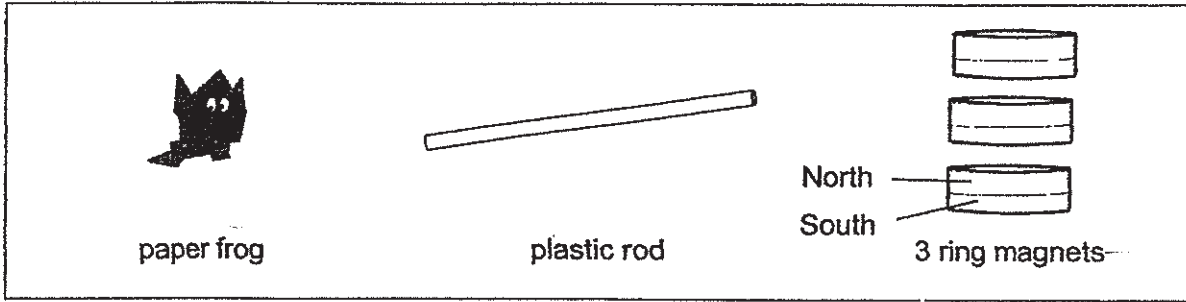

He glued the paper frog onto the top of one of the ring magnets and assembled the toy as shown in Figure 1. When he released the magnet, the frog jumped up as shown in Figure 2.

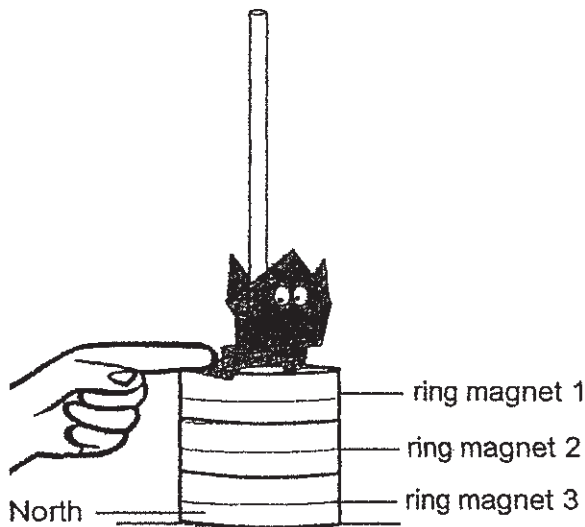

Before magnet was released

Figure 1

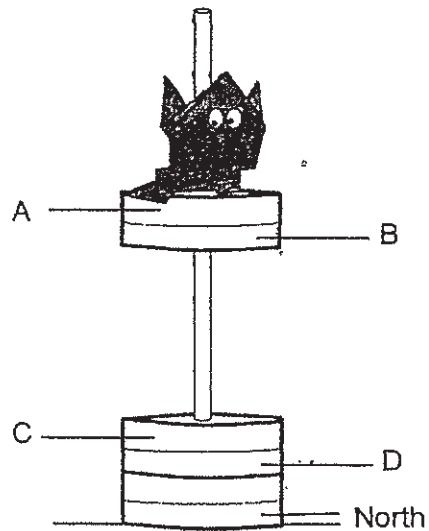

After magnet was released



Figure 2

Which one of the following correctly identifies the poles of ring magnets 1 and 2?

	A	B	C	D
(1)	North	South	South	North
(2)	North	South	North	South
(3)	South	North	North	South
(4)	South	North	South	North

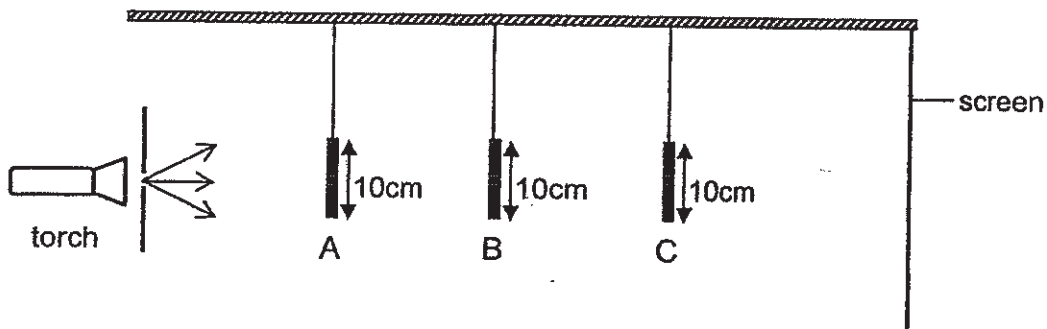
14. The set-up below shows light from a torch shining on three shapes made of different materials. All 3 shapes are placed at different distances from the torch at points A, B and C.



Shape			
Property	Does not allow light to pass through	Allows some light to pass through	Does not allow light to pass through

The experiment was repeated many times such that each shape was placed at all 3 points A, B and C each time.

Which one of the following shadows **cannot** be observed on the screen?

(1)



(2)



(3)



(4)



15. Jamilah conducted an experiment using the set-up as shown below.

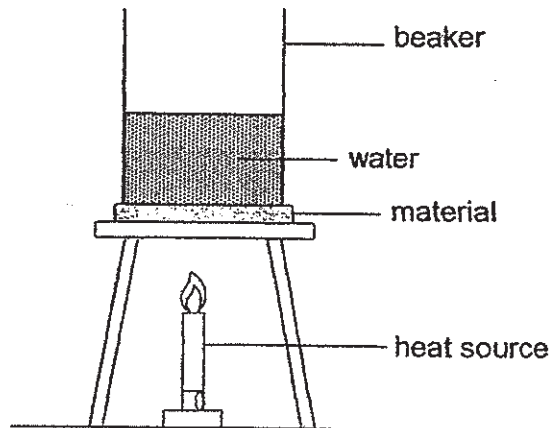

She recorded the time taken for the water to boil when the different materials, A, B, C and D, were placed below the beaker of water.

Material	Time taken for the water to start boiling (min)
A	5
B	10
C	15
D	20

Which of the following material is the most suitable to make a container to store ice-cream such that the ice cream inside will melt the slowest?

- (1) A
- (2) B
- (3) C
- (4) D

16. The following activities involve the use of forces.

- A Squeezing a lemon
- B Wringing a wet towel
- C Attracting a paper clip with a magnet

Which of the following activity/activities involve(s) only a pulling force?

- (1) C only
- (2) A and B only
- (3) A and C only
- (4) B and C only

17. The diagram below shows Mr Tay bouncing a ball to Enzo.

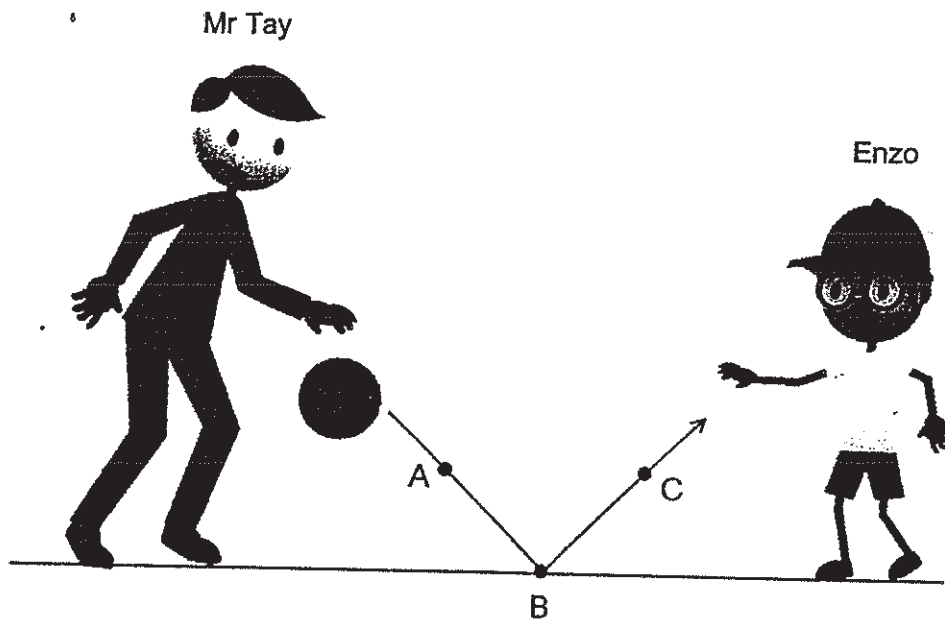

The ball bounced once before Enzo caught it.

Which one of the following statements is correct?

- (1) No force was acting on the ball when it was at B.
- (2) Gravitational force was acting on the ball from A to B.
- (3) There was no gravitational force acting on the ball from B to C.
- (4) Mr Tay exerted both a pushing and pulling force when he bounced the ball to Enzo.

18. Ahmad overlapped the pages of two books, A and B, as shown in the diagram below.

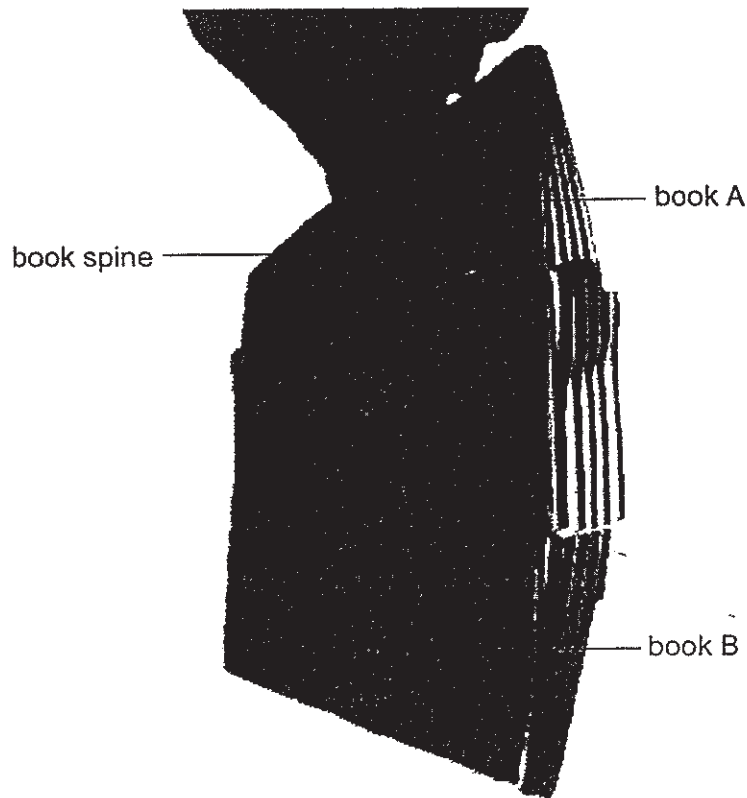

He then held book A only by the book spine and observed that book B did not fall to the ground.

Which one of the following statements explains why book B did not fall to the ground?

- (1) There is gravitational force acting on the books.
- (2) There is frictional force between the pages of the books.
- (3) There is magnetic force between the pages of the books.
- (4) There is frictional force between Ahmad's hands and book A.

19. Declan connected the circuits in four different arrangements, A, B, C and D, as shown below. All the electrical components are working properly.

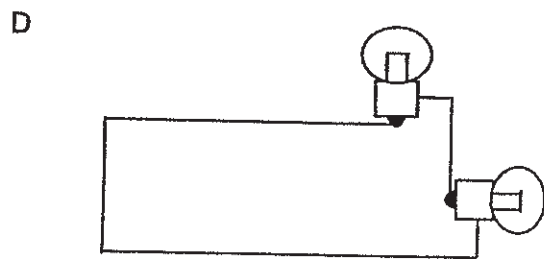
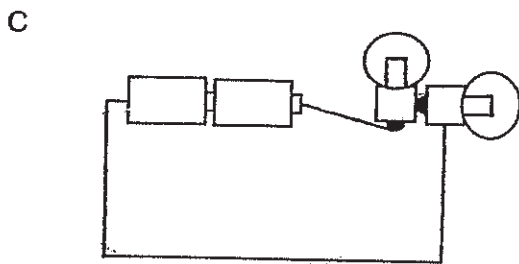
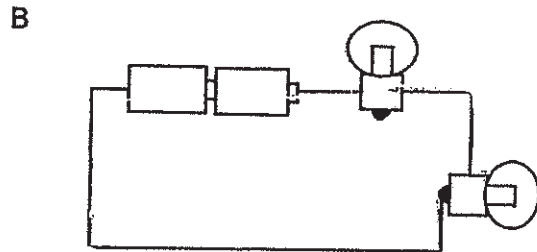
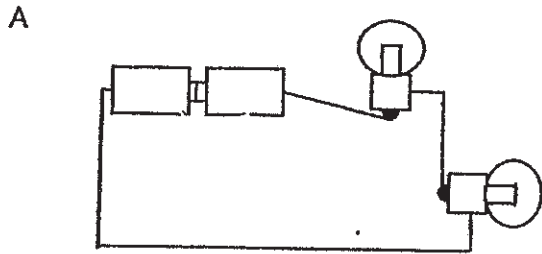

In which of the arrangement(s) would there be at least one bulb that lit up?

- | | | | |
|-----|--------------|-----|-----------------|
| (1) | C only | (2) | A and D only |
| (3) | B and C only | (4) | A, B and C only |

20. Study the circuit diagram below. All the electrical components are working properly.

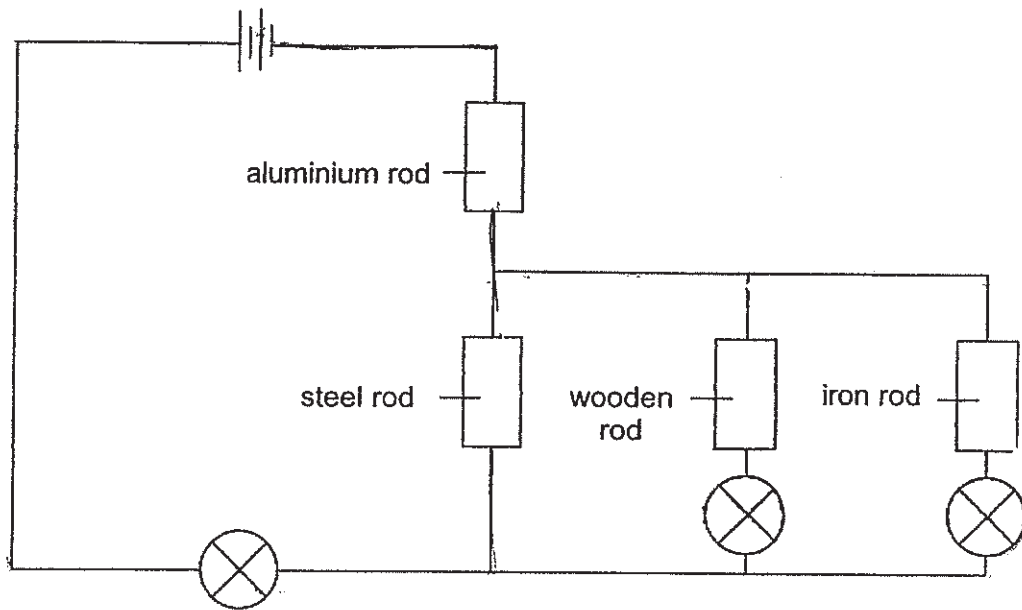

Jerry wanted only one bulb to light up. Which rod should he remove?

- (1) Iron rod
- (2) Steel rod
- (3) Wooden rod
- (4) Aluminium rod

21. Elyssa set up an electrical circuit as shown below using identical bulbs. All the electrical components are working properly. In the beginning, the metal rod was connected to point P and she realised that bulb X lit up.

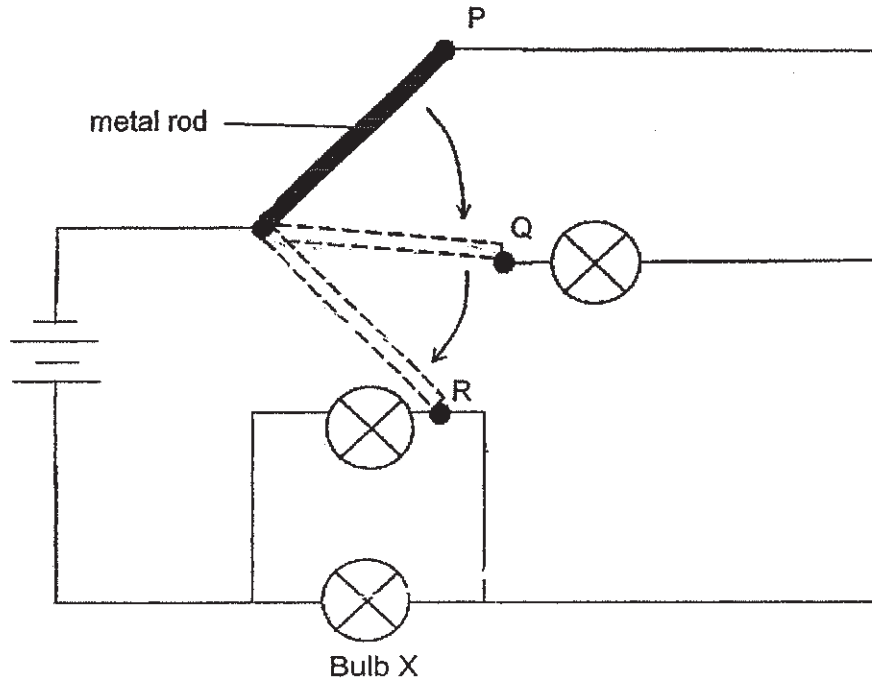

She then moved the position of the metal rod to point Q and compared the brightness of bulb X with that at point P. Next, she repeated the experiment by connecting the rod to point R.

Which of the following statements are true?

	Metal rod connected to	Brightness of bulb X
A	Point Q	decreased
B	Point Q	remained unchanged
C	Point R	decreased
D	Point R	remained unchanged

- (1) A and C only
 (3) B and C only

- (2) A and D only
 (4) B and D only

22. Which of the following are ways to conserve electricity?

- A Using an energy-efficient appliance
- B Using the fan instead of the air conditioner
- C Using the half flush button when flushing the toilet
- D Checking electrical appliances regularly for exposed wires

- (1) A and B only
- (2) C and D only
- (3) A, B and D only
- (4) A, C and D only

23. Riani placed the arrow on the bow and pulled the arrow backwards. When she released the arrow, it flew forward and hit the target board as shown in the diagram below.



Pulling the arrow



target board

Which one of the following shows the **main** energy conversion that took place from the moment Riani pulled the arrow?

	Pulled arrow	Arrow moving in the air	Arrow hit target board
(1)	kinetic energy	heat energy	sound energy
(2)	kinetic energy	kinetic energy + potential energy	potential energy + sound energy
(3)	potential energy	kinetic energy + potential energy	potential energy + heat energy + sound energy
(4)	potential energy	potential energy	kinetic energy

24. The diagram below shows Meiyin on a swing. Aisha gave Meiyin a push on the swing at point Z.

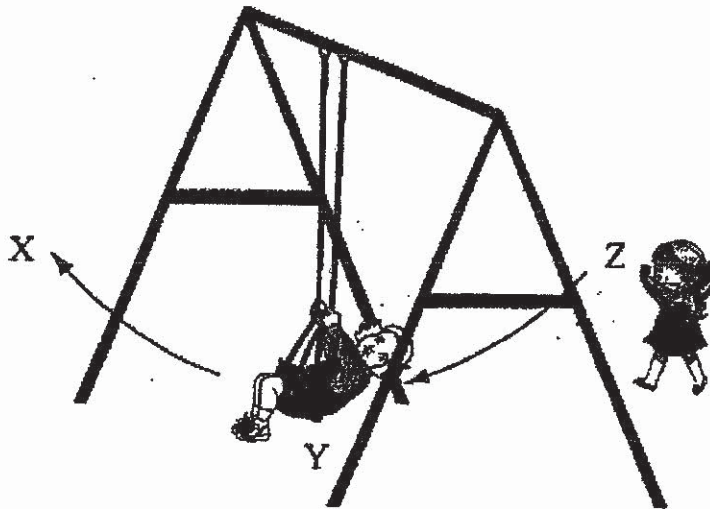

Which point on the graph best represents the amount of kinetic energy that Meiyin possessed when the swing was at point Y?

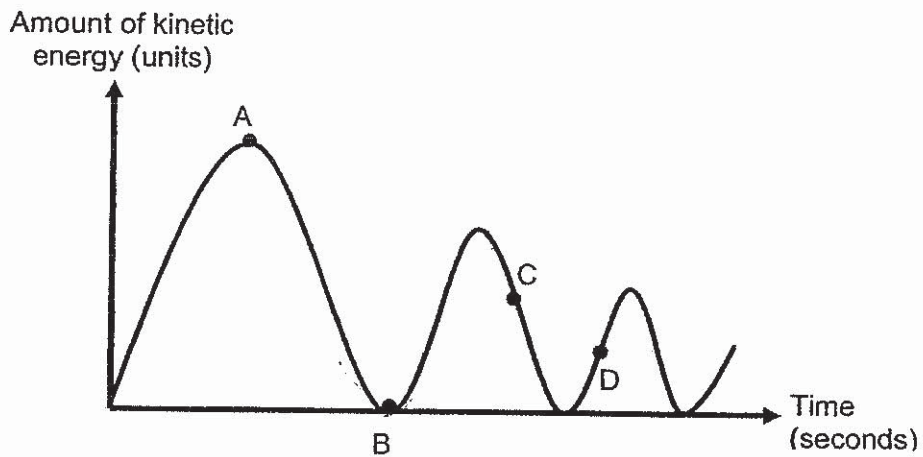

(1) A
(3) C

(2) B
(4) D

25. The diagrams below show 4 different objects, A, B, C and D, which are able to convert different forms of energy to electrical energy.

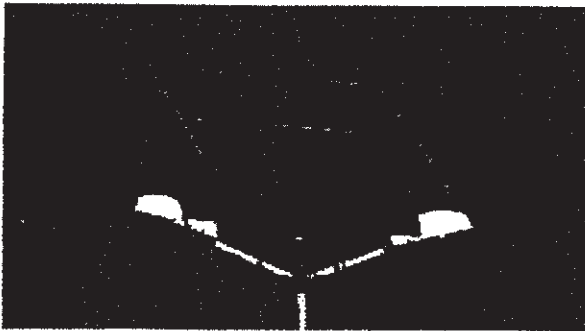

A

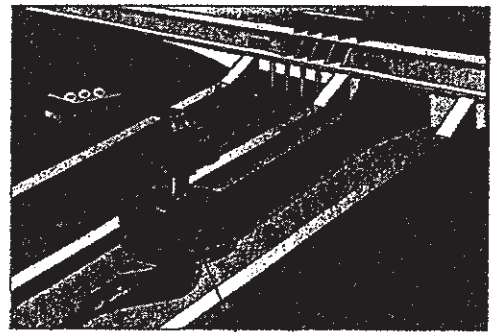

B

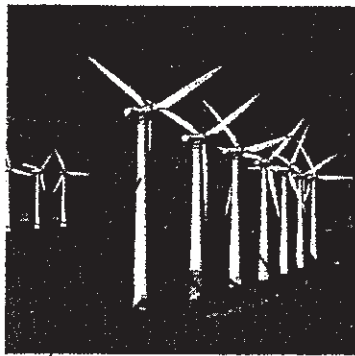

C

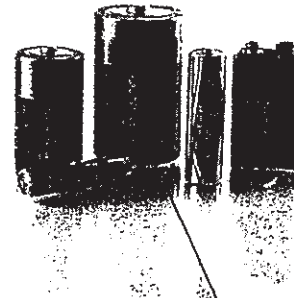

D

Which one of the following identifies the form of energy that is used by each object to convert to electrical energy?

	A	B	C	D
(1)	heat energy	potential energy	light energy	potential energy
(2)	light energy	kinetic energy	kinetic energy	heat energy
(3)	light energy	kinetic energy	kinetic energy	potential energy
(4)	potential energy	potential energy	heat energy	light energy

26. The diagram below shows the 4 different positions of a ball as it was dropped into a pipe. The ball continued to roll until it came to a stop at point D.

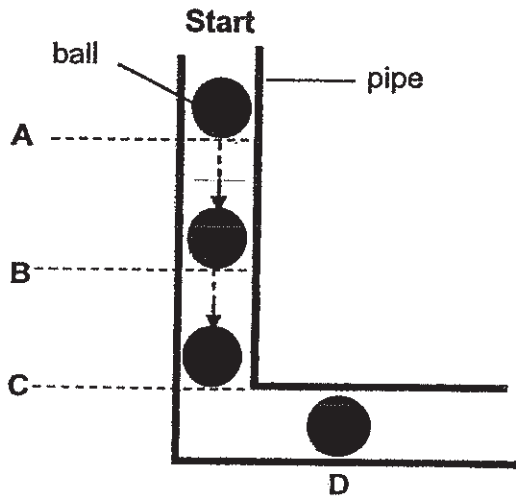

Which one of the following statements about the ball is **correct**?

- (1) The ball at point D has less kinetic energy than at point C.
 (2) The ball has the same kinetic energy at point B and point C.
 (3) Kinetic energy of the ball decreased from point B to point C.
 (4) The ball at point A has greatest kinetic energy and potential energy.
27. Which of the following object(s) do(es) **not** possess any gravitational potential energy?
- A A plane flying in the sky.
 B A ball rolling on the ground.
 C A balloon stuck at the ceiling.
- (1) A only
 (2) B only
 (3) A and C only
 (4) B and C only
28. Which of the following electrical appliance(s) produce(es) **useful** heat energy?
- A A laptop
 B A toaster
 C A handphone
 D An electric iron
- (1) A only
 (2) A and C only
 (3) B and D only
 (4) B, C and D only

~ END OF BOOKLET A ~



NANYANG PRIMARY SCHOOL
PRIMARY 6 SCIENCE
CONTINUAL ASSESSMENT 1
2019

BOOKLET B

Date : 6 March 2019

Duration : 1 h 45 min

Name : _____ ()

Class: Primary 6 ()

Marks Scored:

Booklet A:		56
Booklet B :		44
Total :		100

Any query on marks awarded should be raised by 14 March 2019. We seek your understanding in this matter as any delay in the confirmation of marks will lead to delays in the generation of results.

Parent's signature: _____

**DO NOT OPEN THIS BOOKLET UNTIL YOU ARE TOLD TO DO SO.
FOLLOW ALL INSTRUCTIONS CAREFULLY.**

Booklet B consists of 19 printed pages including this cover page.

Section B (44 marks)

Write your answers to questions 29 to 40 in the spaces provided.

29. Jane placed 100g of meat into each of the set-ups, P, Q and R, as shown below. She cut the meat into 2 equal pieces for set-up Q and 4 equal pieces for set-up R. She then placed the meat into equal volume of digestive juice X, as shown in the diagram below.

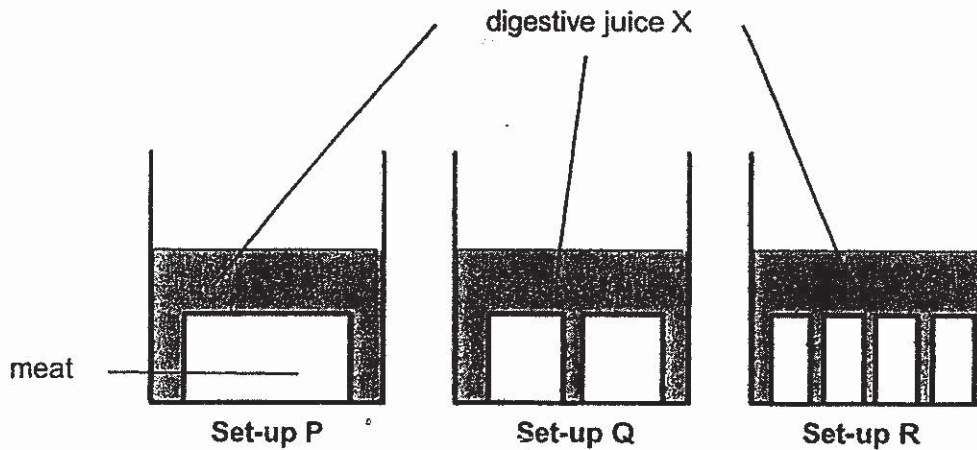

After 30 minutes, she recorded the results in the table below.

Set-up	Total mass of meat (g)	
	At the start of the experiment	After 30 minutes
P	100	(i) <input type="text"/>
Q	100	83
R	100	(ii) <input type="text"/>

- (a) Based on the information above, what was the aim of Jane's experiment? [1]

- (b) Write in the table above, the most likely mass of the meat after 30 minutes for set-ups P and R. [1]



- (c) Based on the experiment conducted by Jane, explain why food should be chewed properly before being swallowed. [1]

30. Reshnan observed the following cell under the microscope.

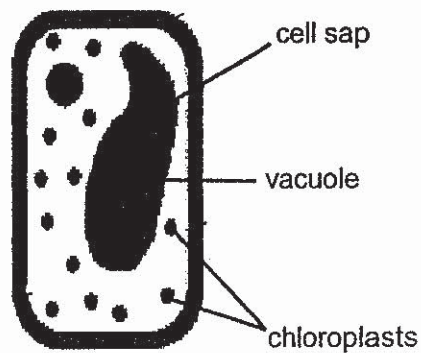

- (a) In the diagram above, **label and name** another part of the cell that is only present in this type of cell. [1]

- (b) Identify the part of the living thing that the cell above was most likely taken from. [1]

- (c) State the function of the chloroplast present in the cell. [1]



31. Xiu Ming collected 3 water samples, X, Y and Z, from different parts of a pond. He shone the same amount of light through the same amount of water sample. The diagrams below show the shadows that were cast on the papers placed below each water sample.

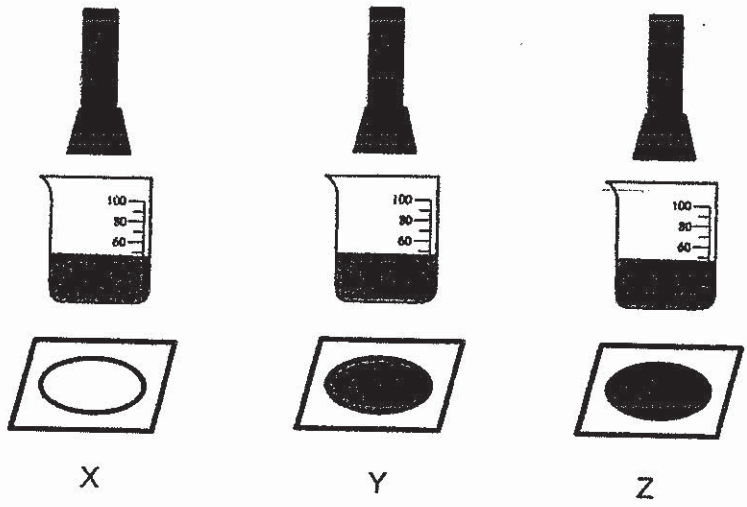

Xiu Ming then set up another 3 setups, each containing the same amount of water samples, X, Y and Z, and water plants as shown in the diagram below. He placed the 3 setups in the same brightly lit room for 2 days.

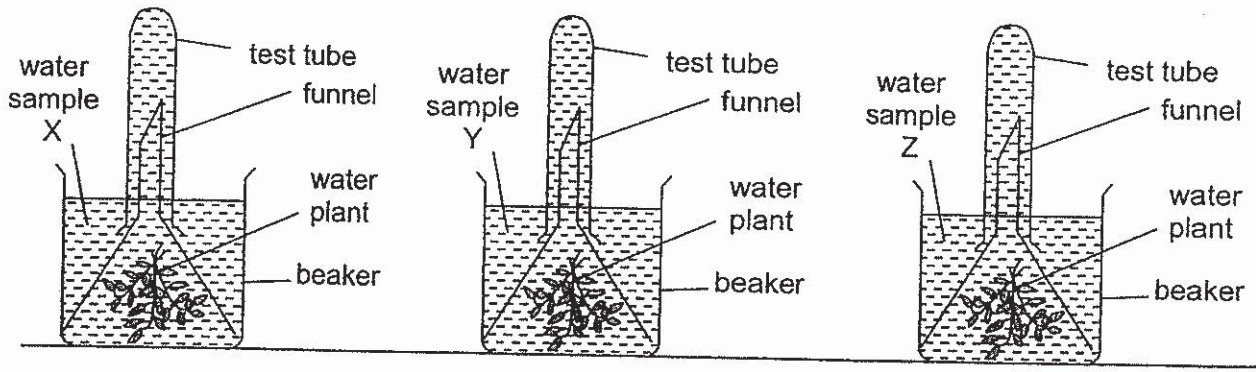

At the end of the 2 days, he measured the amount of gas collected in the test tube of each water sample.

(a) Match each water sample, X, Y and Z, with the results as shown in the table below. [1]

Water sample	Amount of gas collected (units)
	13
Ø	20
	8

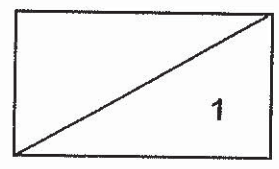

(b) Name the gas collected at the end of each test tube. [1]

Xiu Ming used another water sample W and conducted the same experiment to find out how temperature of the water will affect the amount of gas collected.

The graph below showed the result.

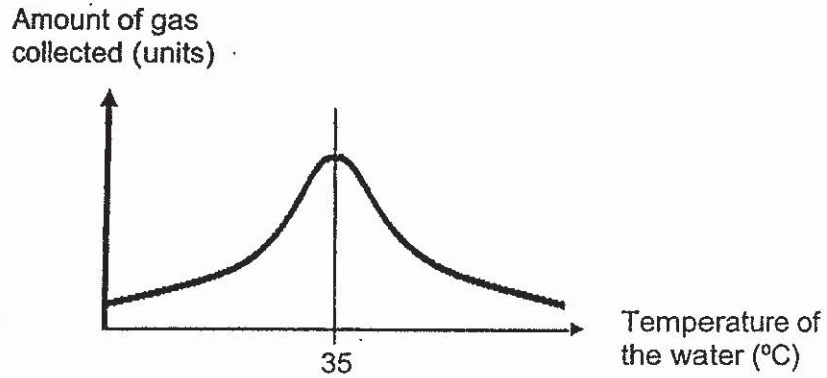

(c) Based on the graph above, describe the relationship between temperature of the water and the rate of photosynthesis. [2]

(d) Describe the process of photosynthesis. [1]

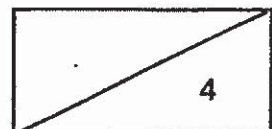

32. Xiao Qing placed 2 irregularly-shaped objects, each at the base of a 500ml beaker. She then filled each of the beakers with water to the same height as shown in the diagram below.

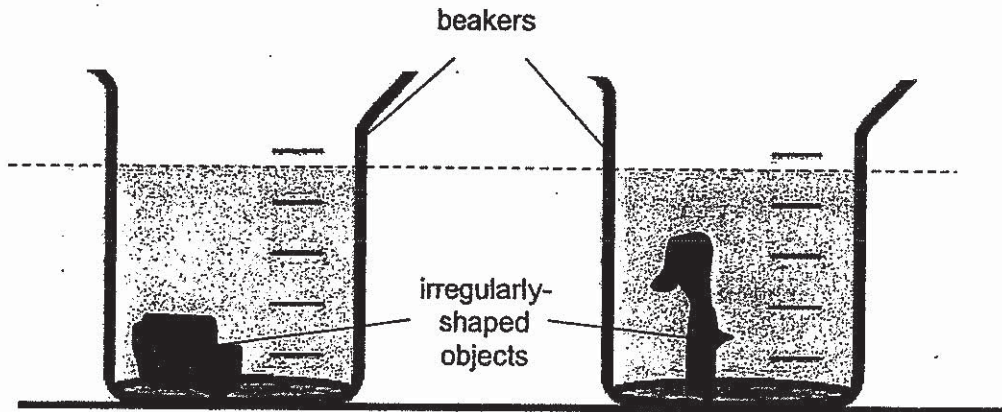

Describe and explain what Xiao Qing can do in order to find out which of the two objects has a greater volume.

[2]

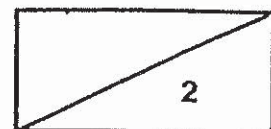

33. Oliver took a beaker of water at 60°C and placed it in a classroom at room temperature for 10 minutes as shown in the diagram below.

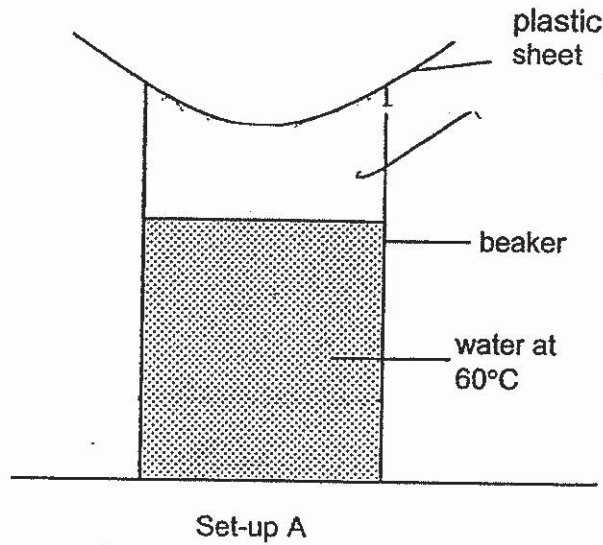

(a)(i) Draw and label in the diagram above to show where the water droplets were observed after 5 minutes. [1]

(a)(ii) Explain how the water droplets in set-up A were formed. [1]

(b) Using the same plastic sheet and beaker, explain how he could increase the amount of water droplets forming in set-up A. [2]

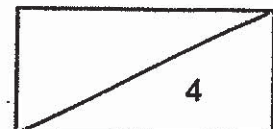

34. Joe wanted to find out how the size of the beaker affects the amount of water left in the beaker. He set up an experiment as shown below.

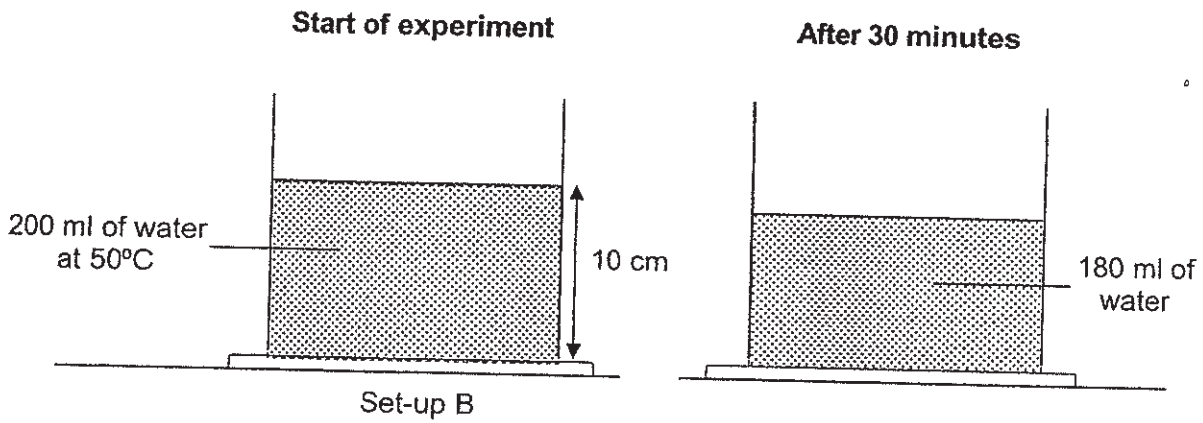
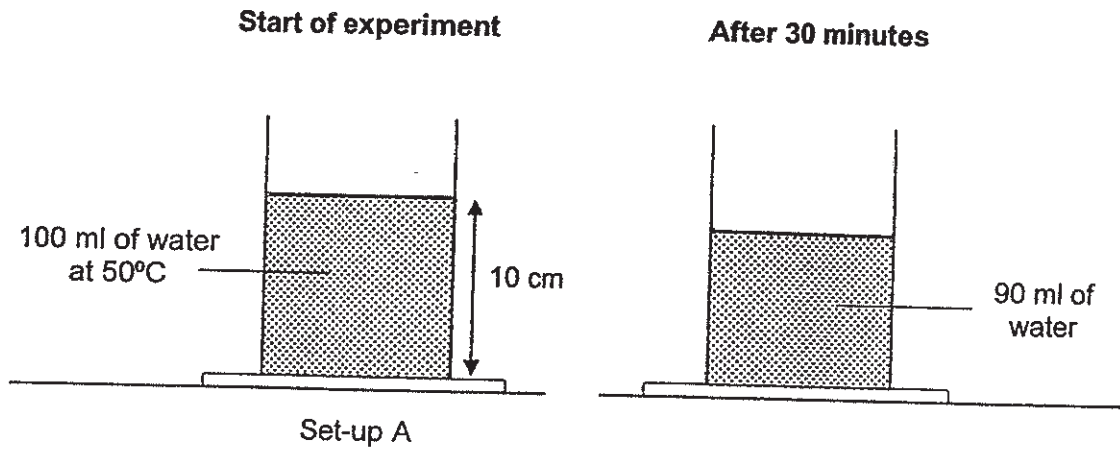

- (a)(i) Based on the experiment above, explain why it is not a fair test. [1]

- (ii) State one change Joe should make to the set-up above to achieve his aim of the experiment. [1]

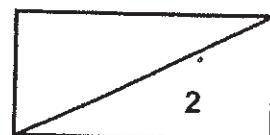

The diagram below shows a dryer. When the dryer is switched on, clothes placed in this machine are tumbled around in the drum many times. Hot air is blown continuously at the clothes. Many households use the dryer during the rainy seasons.

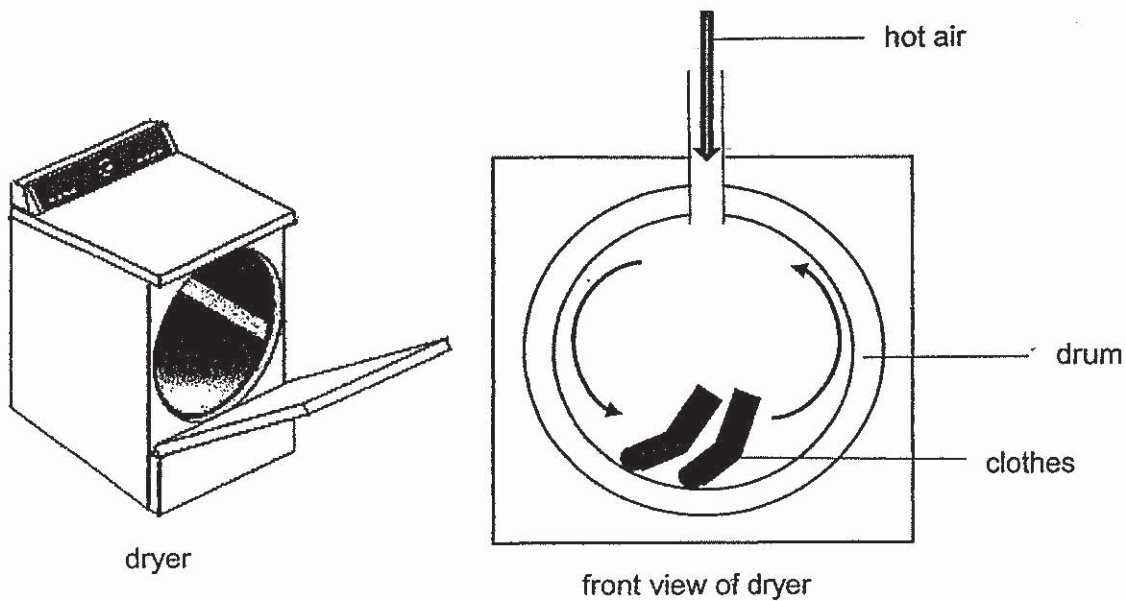

(b) Based on the information above, explain how the following actions help the clothes to dry faster. [2]

(i) **Tumbling of clothes in the drum**

Explanation:

(ii) **Continuous blowing of hot air at the clothes**

Explanation:

35. Alice hung magnet A over a tray of plastic, steel and copper paper clips as shown in the diagram below.

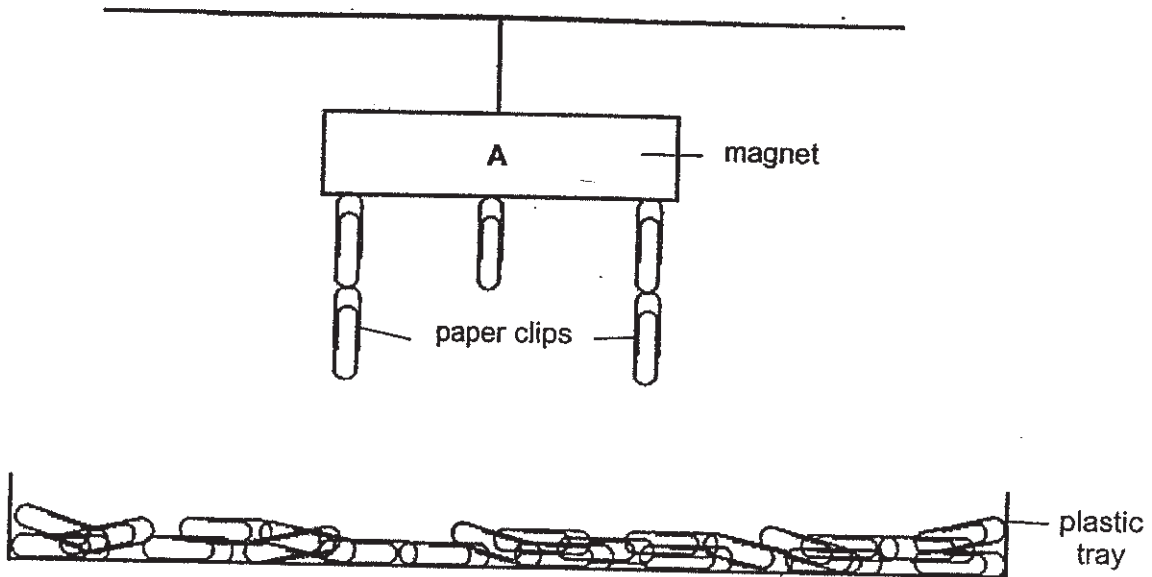

- (a) Which type(s) of paper clips above would the magnet attract? Give a reason for your answer. [1]

- (b) She observed that the poles of magnet A attracted the most number of paper clips. Give a reason to explain her observation. [1]

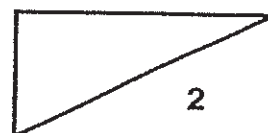

Alice changed the set up and hung magnets B and C. She then placed a tray of paper clips and observed the number of paper clips attracted by each magnet as shown below.

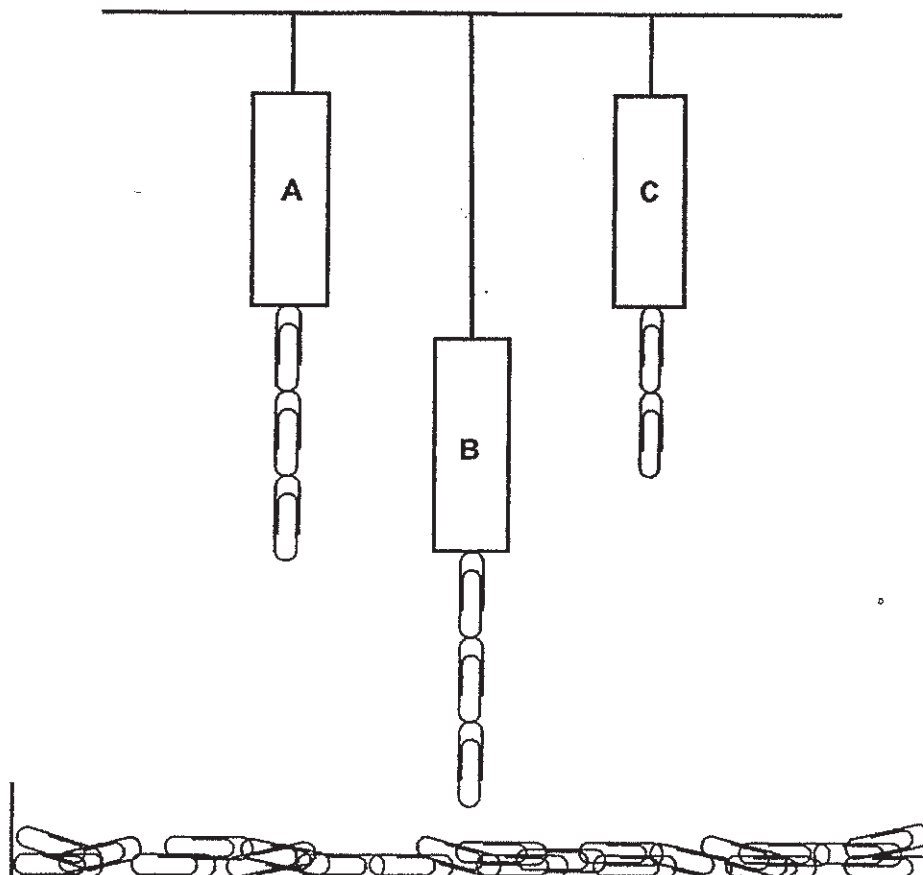

Alice said that magnet A has a weaker pull than magnet B and C.

(c) Explain why her statement is incorrect.

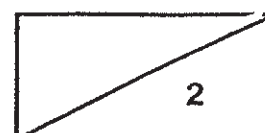

36. Tim carried out the following experiment in a dark room.

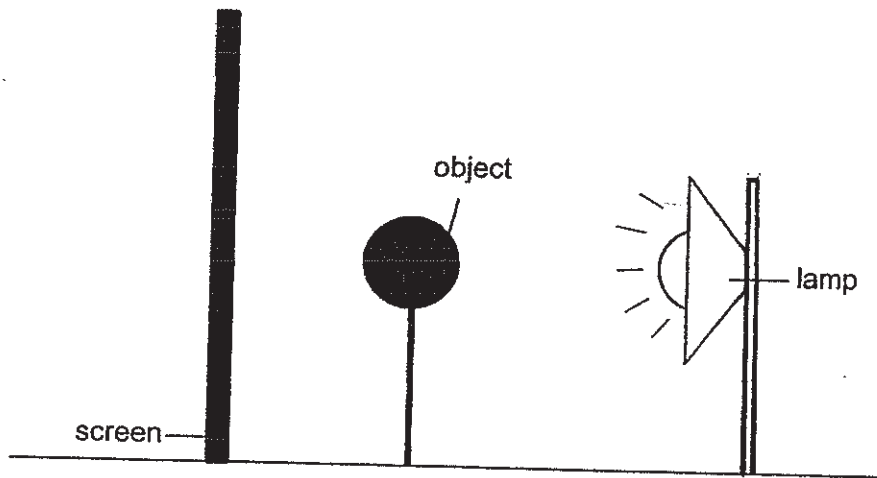

(a) Without moving the screen state two changes that he could make to the set-up above to **decrease** the size of the shadow formed on the screen. [1]

(i) _____

(ii) _____

(b) Explain why Tim conducted the experiment in a dark room. [1]

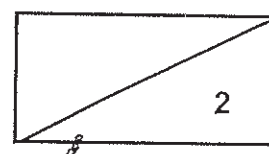

Tim then entered the room and used a mirror to view the object as seen in the diagram below.

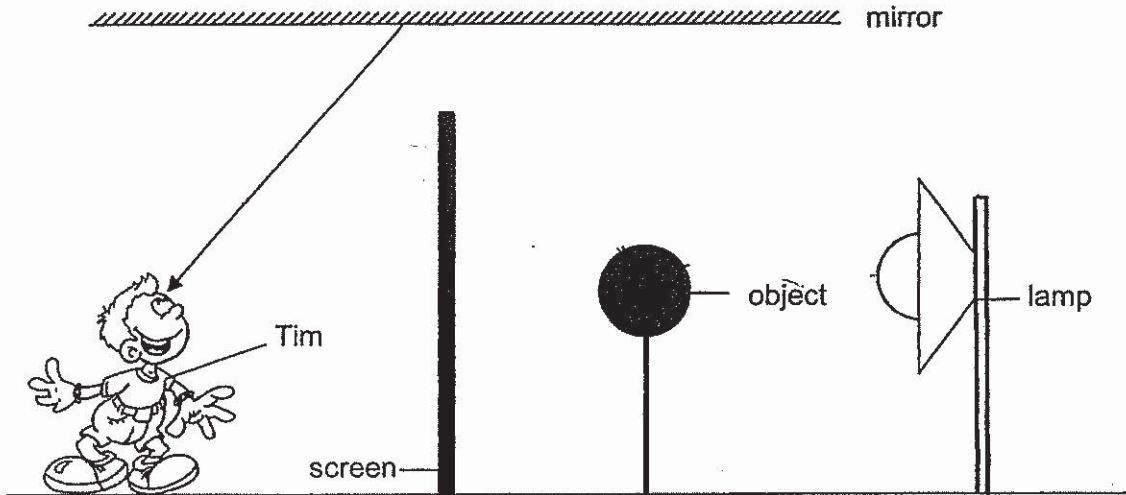

(c) **Complete the light rays** in the diagram above to show how Tim was able to see the object in the mirror. [1]

(d) State 2 properties of light that enabled Tim to see the object. [1]

- (i) _____
- (ii) _____

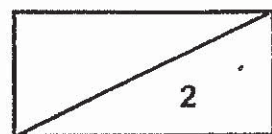

37. Shane hung different masses on a stretchable string of 20 cm to find out how the mass hung on the string affects the length of the string. He recorded his results in the graph below.

length of string (cm)

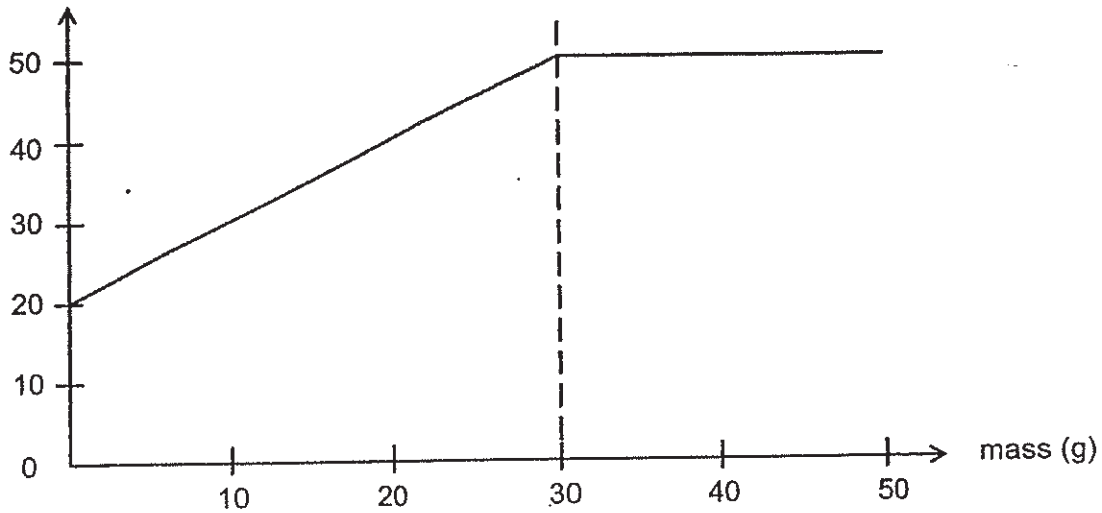

Joe said that the graph was wrong because Shane should have drawn the graph starting from 0 cm.

- (a) Explain why Joe was wrong. [1]

- (b) What is the relationship between the mass hung on the string and the length of the string? [2]



Shane constructed a bow using a rod and the same string from his experiment.

He pulled the string back, together with the arrow, to position A before releasing the arrow. He then measured the distance travelled by the arrow. He repeated the steps by stretching to positions B and then C.

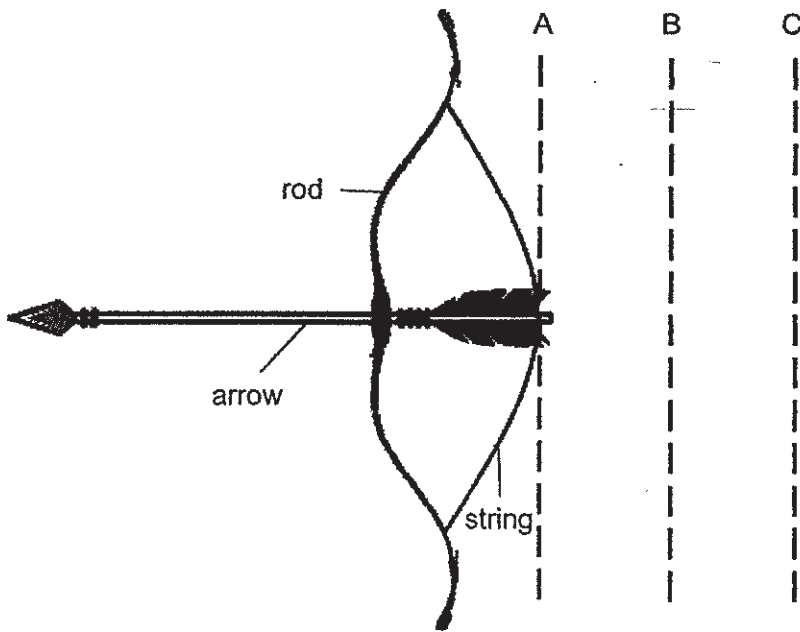

- (c) In which position would the arrow be able to travel the furthest distance? Explain your answer in terms of forces. [2]

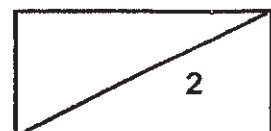

38. The diagram below shows a wooden hammer fixed at one end which enable it to swing freely. A tennis ball was placed just touching the fixed end of the wooden hammer so when the wooden hammer was released, it would hit the ball causing it to roll and hit the bell.

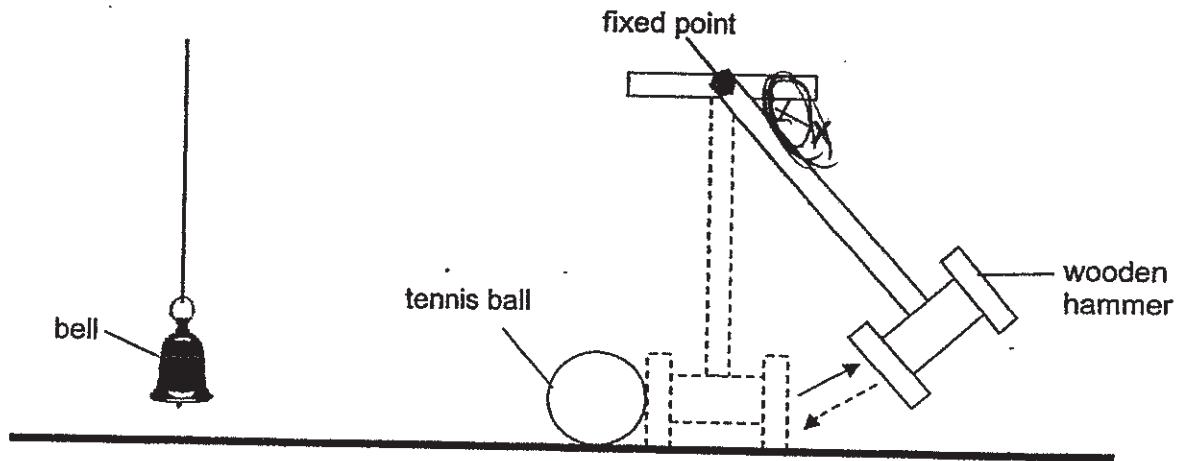

- (a) What is the relationship between angle X and the volume of the sound of the bell makes?

[1]

- (b) State the main energy conversion in the experiment above.

[1]

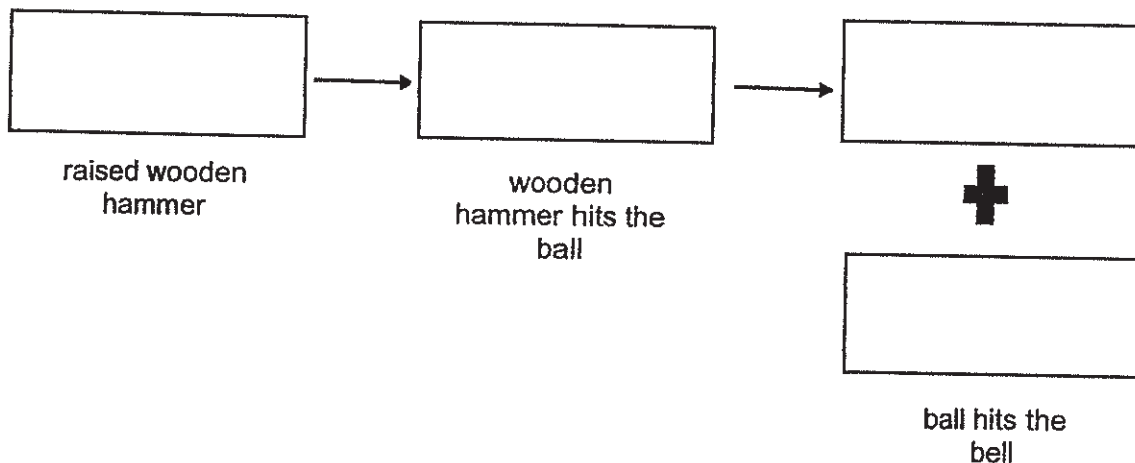

- (c) Explain why the sound of the bell was louder when a wooden hammer of a greater mass was used.

[1]

39. When a marble was released from point A of a bowl as shown in the diagram below, it moved up the opposite side of the bowl.



(a) (i) Mark **point X** on the diagram above to show the highest point the marble will most likely reach on the opposite end of the bowl. [1]

(a) (ii) Explain your answer above in terms of energy conversion. [1]

The experiment was repeated with three identical marbles on three different containers, J, K and L. The containers were made of identical materials and were of the same width.

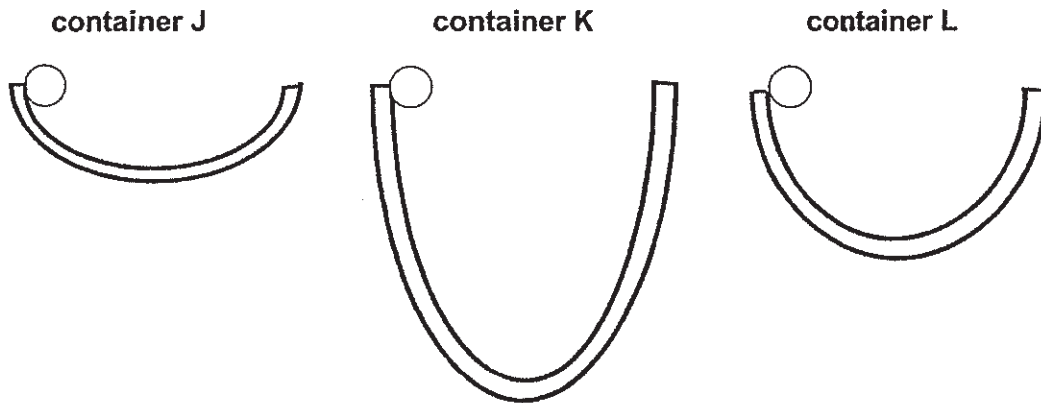

(b) Arrange the containers above starting with the one which will allow the marble to take the shortest time to stop. [1]

Stop within the shortest time \longrightarrow Stop after the longest time

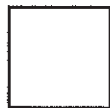

(c) Suggest one way to enable the marble in container J to roll for a longer time than it originally did. [1]

40. Ruth created her own wire loop game and connected the circuit as shown in the diagram below.

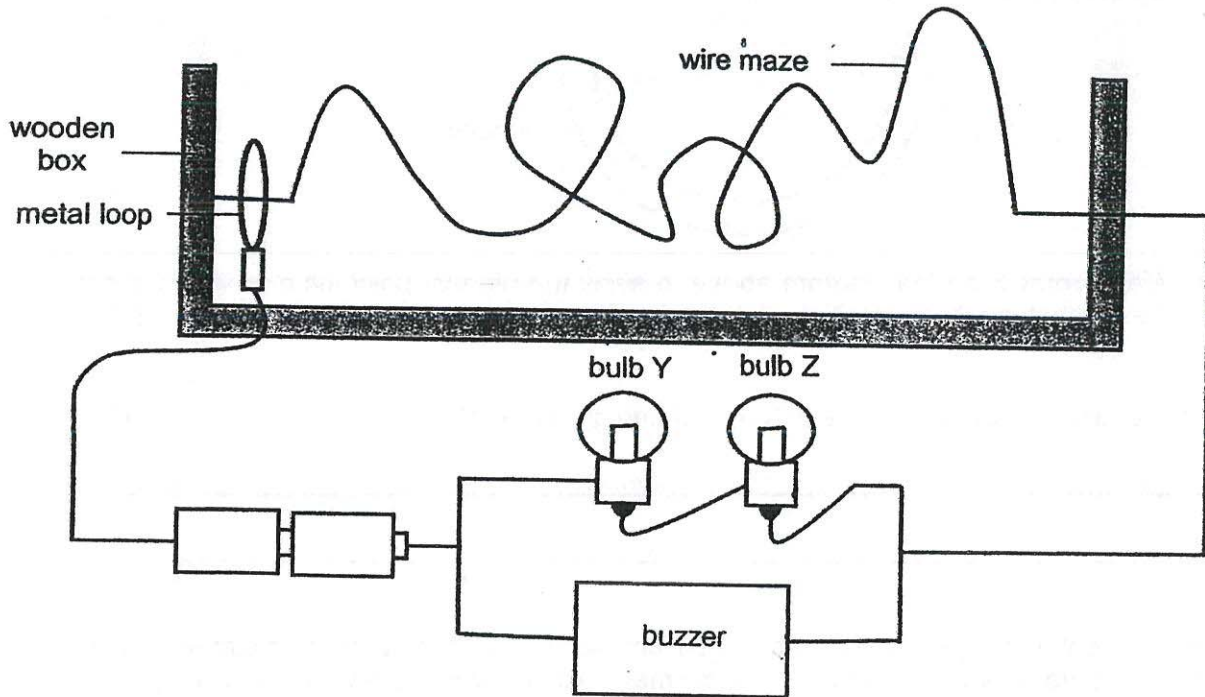

She moved the metal loop through the wire maze. She observed that when the metal loop came into contact with the wire maze, both the bulbs lit up and the buzzer rang.

- (a) Give a reason for her observation. [1]

- (b) Describe what she would observe about bulb Z and the buzzer when the metal loop came into contact with the wire maze, if bulb Y fused. [2]

Bulb Z: _____

Buzzer: _____

~ END OF BOOKLET B ~

Suggested Answer Key
Section A

1	3	11	2	21	2
2	2	12	2	22	1
3	4	13	1	23	3
4	1	14	2	24	1
5	2	15	4	25	3
6	1	16	1	26	1
7	4	17	2	27	2
8	3	18	2	28	3
9	1	19	3		
10	1	20	1		

Section B

Qn No	Answers
29a	To find out how the exposed surface area of the meat affects the rate of digestion of meat.
b	P→ less than 100, more than 83 R→ less than 83, more than 0
c	Chewing helps to break down the food into smaller pieces so that the food can be digested faster.
30a	Identify and label cell wall in diagram
b	Leaf / green stem
c	Traps light for the plant to make food
31a	Y, X, Z
b	Oxygen
c	Rate of photosynthesis increased with increasing temperature until it reached 35°C. After 35°C, rate of photosynthesis decreased with increasing temperature.
d	Photosynthesis is the process of plant <u>making their own food</u> using <u>light, carbon dioxide and water</u> .
32	Remove the objects from the containers. Compare the water level. The container with the lower water level had the object with the greater volume as it took up more space.
33a	i) Draw & label water droplets on the underside of the plastic sheet/inner side of the beaker ii) Water in the beaker will evaporate. Water vapour in the beaker will condense on cooler surface of the plastic sheet.
b	Increase the temperature of water in the beaker. The warmer water will have a <u>greater rate of evaporation</u> . <u>More water vapour will condense</u> on the plastic surface, forming more water droplets. Add ice to the plastic/cool down the surrounding room temperature. The <u>surface of the plastic will be cooler</u> because of the ice. <u>Faster rate of condensation</u> on the plastic sheet to form more water droplets.
34a	i) Both the volume of water at the start and size of beaker have been changed so

	more than 1 variable was changed. ii) Pour out 100ml from set-up B or add 100 ml to set-up A, (keeping the temperature to 50°C).
b	i) Different surfaces exposed to the hot air to increase the rate of evaporation of water ii) Increase the surrounding temperature/ increase wind speed to increase the rate of evaporation of water
35a	Magnet A would attract the steel paper clips because steel is a magnetic material but copper and plastic are not magnetic.
b	The magnetic force of attraction of a magnet is the strongest at its poles.
c	Magnet A has a stronger pull than magnet B because magnet A attracted the same number of paper clips from a greater height. Magnet A also has a stronger pull than magnet C because magnet A can attract more paper clips than magnet C from the same distance.
36a (i)	-Shift the lamp further away from the object/screen
(ii)	-Shift the object closer to the screen
b	To ensure that the shadow is darker/ clearer/ sharper
c	Light ray from lamp, to object, to mirror.
d	1) Light travels in a straight line (0.5m) 2) Light can be reflected (0.5m)
37a	Joe is wrong because the original length of the string is 20 cm, hence the y-axis needs to start at 20 cm, not 0 cm.
b	As the mass hung on the string increases, the length of the string increases until 30g. After this point, when the mass hung on the string increases, the length of the string remained the same.
c	Position C. At C, the string is stretched the most. So, it had the most elastic spring force, allowing the arrow to travel the furthest distance.
38a	The smaller angle X is, the louder sound the bell will make.
b	PE → KE → KE + SE (spell out!)
c	The hammer with greater mass will have a greater potential energy when raised to the same height so it when it hit the ball, the ball will have higher kinetic energy to sound the bell louder.
39a	i) Point X must be lower than original starting point, at the opposite side. ii) When the marble rolled down some of the kinetic energy has been converted to sound and heat energy so it will move up the other side with less kinetic energy to reach a lower height.
b	J, L, K
c	Give the marble a push/ apply lubricant in the bowl/Release the marble from a greater height
40a	When the metal loop comes into contact with the wire maze, there is a closed circuit/ electricity flows through.
b	Bulb Z: Bulb Z will not light up. Buzzer: The buzzer will ring.