



AI TONG SCHOOL

2013 SEMESTRAL ASSESSMENT (2)

PRIMARY FOUR SCIENCE

DURATION : 1hr 45 min

DATE: 25 October 2013

INSTRUCTIONS

**Do not open the booklet until you are told to do so.
Follow all instructions.
Answer all questions.**

Name : _____ ()

Class : Primary 4 _____

Parent's Signature : _____

Date : _____

Section A	60
Section B	40
Total	100

Section A: 60 marks

For each question from 1 to 30, four options are given. One of them is the correct answer. Make your choice and shade the oval (1, 2, 3 or 4) on the Optical Answer Sheet. (60 marks)

1. The diagram below shows the life cycle of an animal.

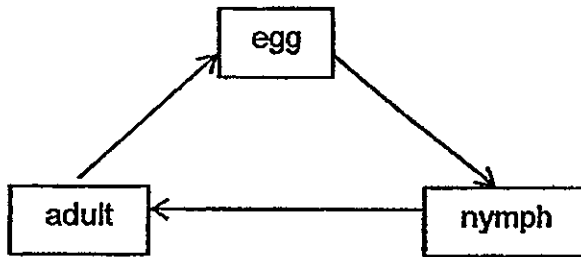

Which animal is likely to have the life cycle as shown above?

- (1) beetle
- (2) chicken
- (3) butterfly
- (4) cockroach

2. Which one of the following objects can be bent easily without breaking?

(1) a sheet of glass



(2) a wooden ruler



(3) a towel

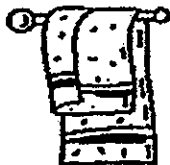

(4) a plastic spoon



3. The diagram below shows the growth of a young plant with two missing stages P and Q.

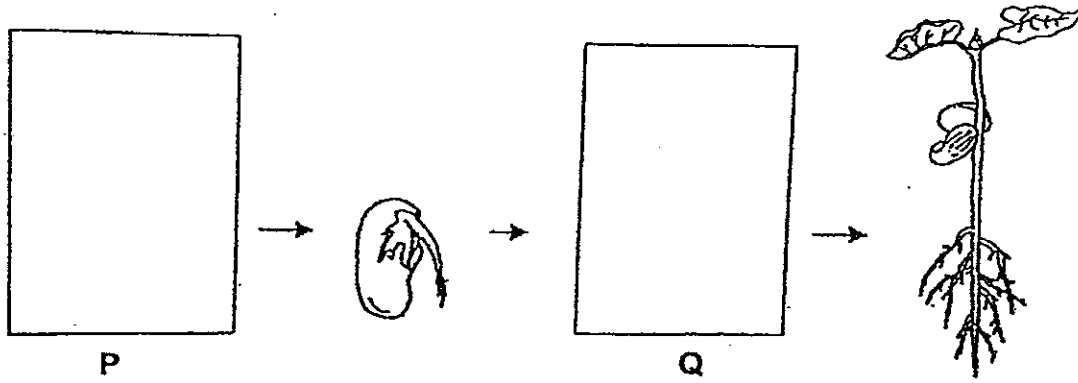

Which one of the following shows the correct stages for P and Q?

	P	Q
(1)		
(2)		
(3)		
(4)		

4. The diagram below shows a young plant.

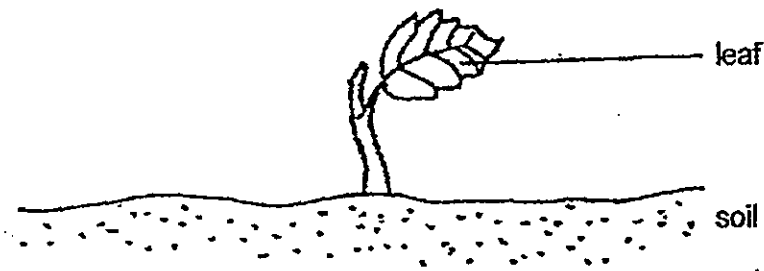

The leaf helps the plant to _____.

- (1) make food
- (2) grow upright
- (3) absorb water
- (4) absorb nutrients

5. Study the chart below.

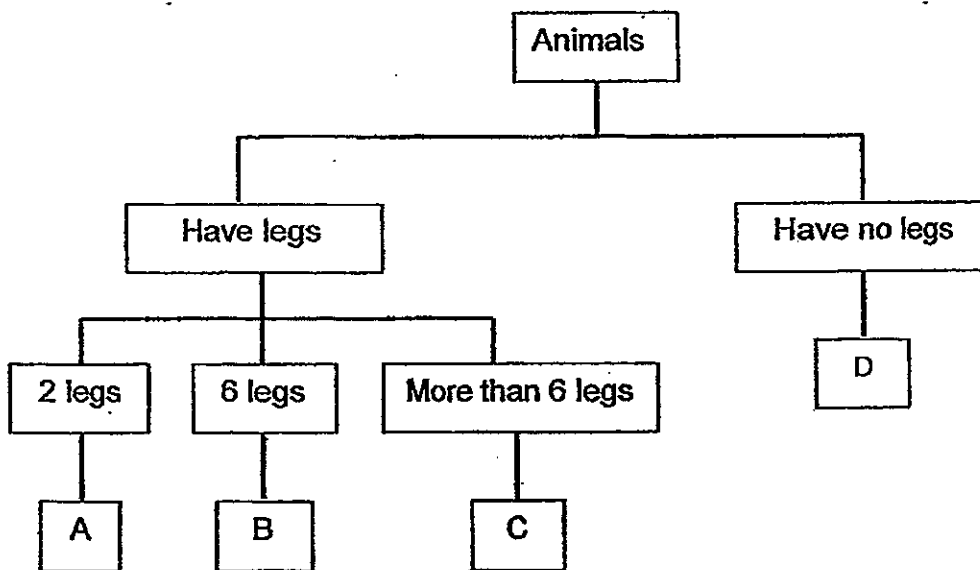

Where would you put this animal in the chart above?

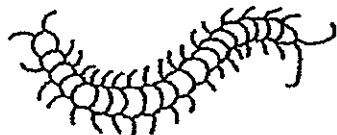

- (1) A
- (2) B
- (3) C
- (4) D

6. Which one of the following shows the correct order when food moves through some parts of the digestive system?

(1)



(2)

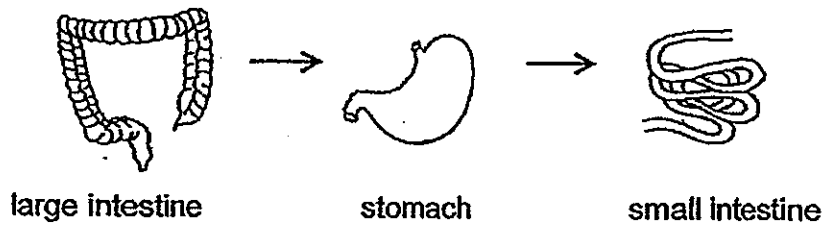

(3)



(4)

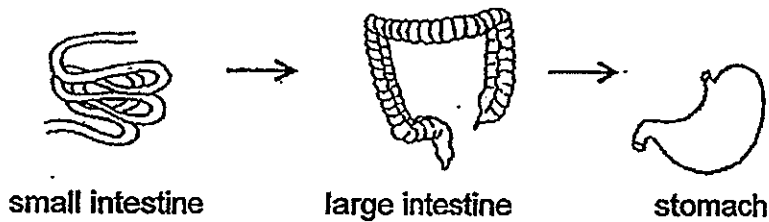

7. Which of the following properties is true for both air and a pencil?

- (1) They can be seen
- (2) They take up space.
- (3) They have fixed shapes.
- (4) They have fixed volumes.

8. The set-up below shows light shining on a wooden ball.

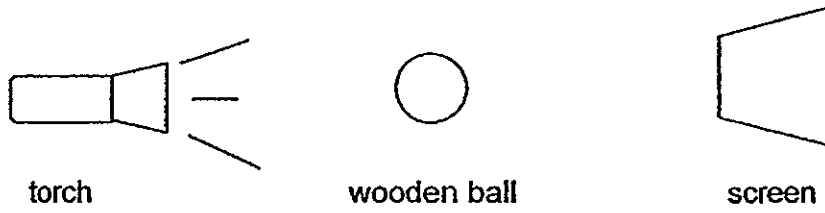

Which one of the following would likely be seen on the screen?

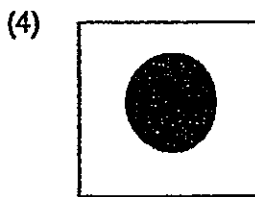
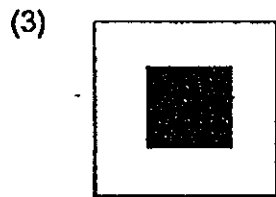
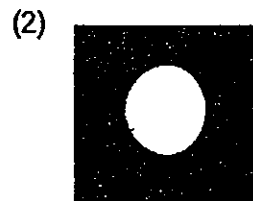
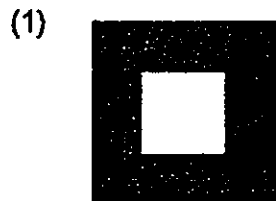

9. Which one of the following is the best conductor of heat?

- (1) paper plate
- (2) plastic plate
- (3) metal plate
- (4) wooden plate

10. In which of the following will the two magnets push each other away?

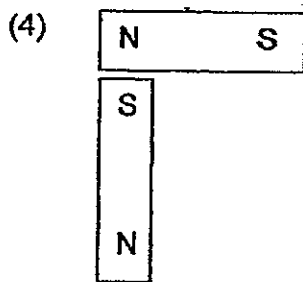
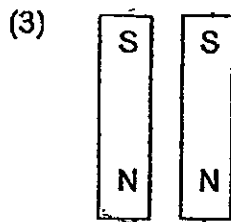
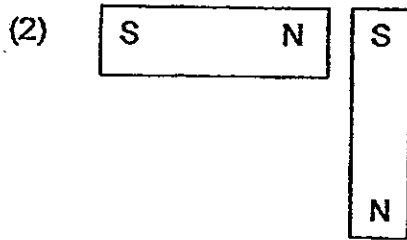
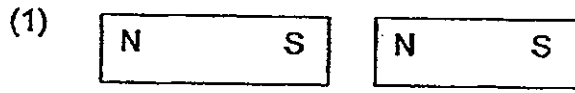

11. The graph below shows the number of days in each stage of the life cycle of animal X.

Number of days

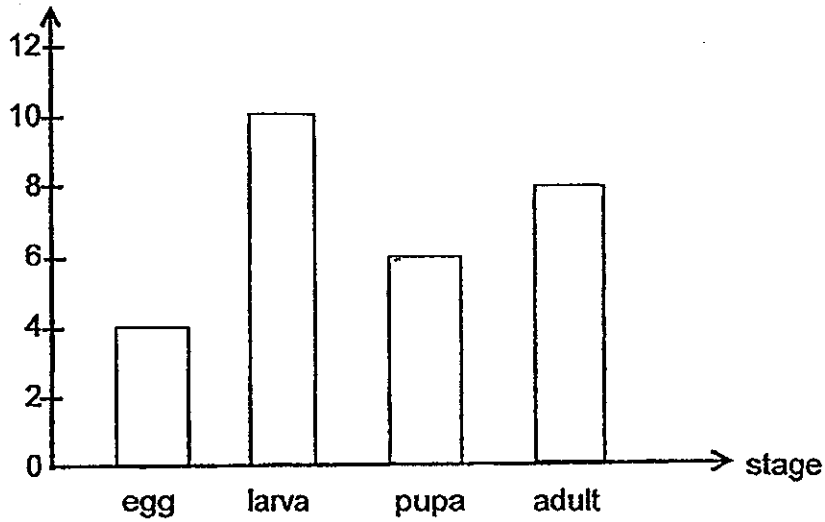

Which of the following statement(s) is/are true?

- A The egg takes 4 days to hatch.
- B There are only 3 stages in the life cycle of animal X.
- C It takes 20 days for animal X to become an adult after it is hatched.

- (1) A only
- (2) C only
- (3) A and B only
- (4) B and C only

12. Jenny wanted to find out if the amount of water given to each plant affects its growth. She planted 3 plants of similar sizes in 3 pots, X, Y and Z. The pots were made of clay. The type of soil used was the same for all the 3 pots.

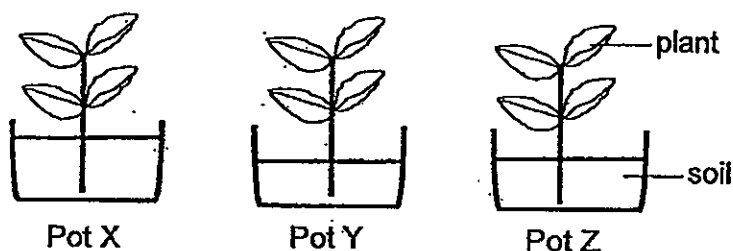

The 3 plants were then placed in the garden.

Why was the experiment not a fair test?

- (1) The type of soil used was the same.
- (2) The pots were made of the same material.
- (3) The amount of soil in each pot was different.
- (4) The plants were given different amount of water.



13. Trina conducted an experiment to find out the characteristics of three objects, X, Y and Z. A tick (✓) means that the objects have the characteristics.

	X	Y	Z
Bends easily	✓	✓	✓
Stretches easily	✓	✓	
Absorbs water		✓	✓

Which one of the following sets of objects best fits the description in the table above?

	X	Y	Z
(1)	rubber boots	cardboard	rubber band
(2)	paper	sponge	rubber band
(3)	rubber band	socks	cardboard
(4)	cardboard	rubber band	socks

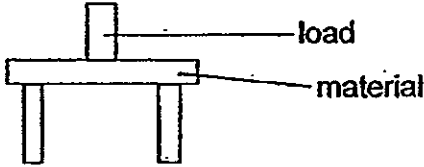
14. Mrs Chua had 4 different materials. She cut a strip of the same length, width and thickness out of each material. She asked her class to carry out 3 different tests with the materials.

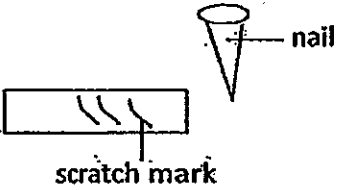
Test	Aim of experiment
A	<p>To find out how many loads are being placed on the material before the material breaks.</p> 
B	<p>To find out how much the material can bend when a fixed amount of strength is applied to it.</p> 
C	<p>To find out how deep the scratch mark is when a nail is used to scratch the material.</p> 

Which of the above tests can the pupils use to find out which material is the strongest and hardest?

- (1) A only
- (2) B only
- (3) A and C only
- (4) B and C only

15. Which of the following statements are reasons why food needs to be chewed before being swallowed?

- A to cut the food into smaller pieces
- B so that saliva will not be produced
- C to increase exposed surface area of food
- D to fully digested the food in the mouth

- (1) A and B only
- (2) A and C only
- (3) B and D only
- (4) A, C and D only

For questions 16 and 17, refer to the diagram below. The diagram below shows the human digestive system.

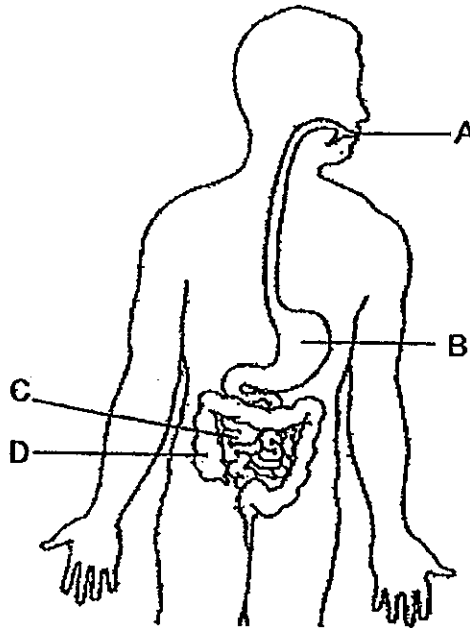

16. Which of the above organs produce digestive juices?

- (1) A, B and C only
- (2) A, C and D only
- (3) B, C and D only
- (4) A, B, C and D only

17. X, Y and Z are samples of the same food taken from different parts of the digestive system.

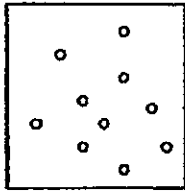

Sample X

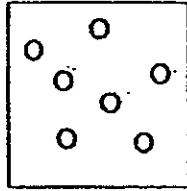

Sample Y

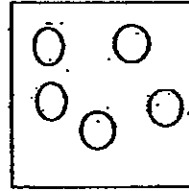

Sample Z

From which part of the digestive system could samples X, Y and Z be taken from?

	Sample X	Sample Y	Sample Z
(1)	A	B	C
(2)	B	C	A
(3)	C	B	A
(4)	D	C	B

18. A syringe is filled with water. When its plunger is pushed, a jet of water shoots out in the direction as shown in the picture below.

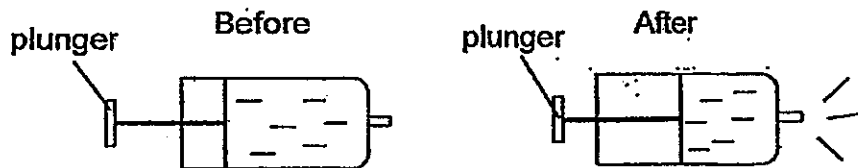

Which of the following statements are true about the air and water in the syringe after its plunger is being pushed?

- A The volume of air has increased.
- B The mass of air has decreased.
- C The volume of water has increased.
- D The mass of water has decreased.

- (1) A and D only
- (2) B and D only
- (3) A, B and C only
- (4) B, C and D only

19. During the school holidays, Jia Min watched a shadow puppet performance where dark shadows of figures were cast on a cloth screen.

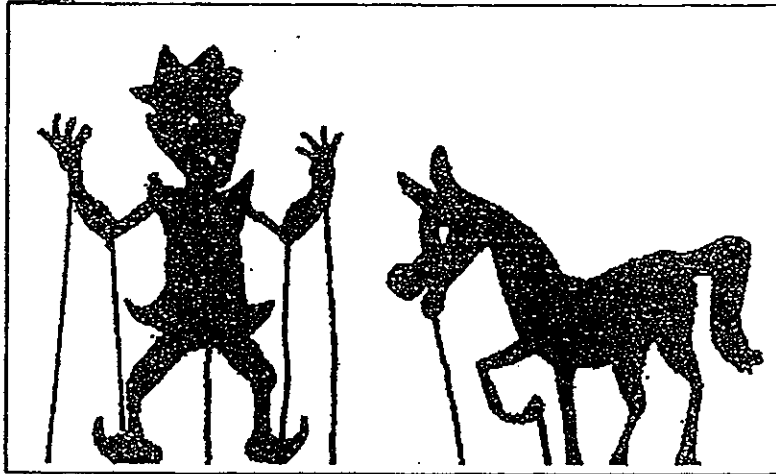

Which of the following shows the correct arrangement of the puppet, screen and light source?

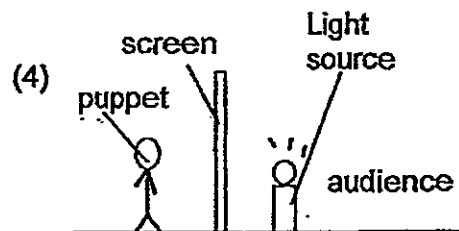
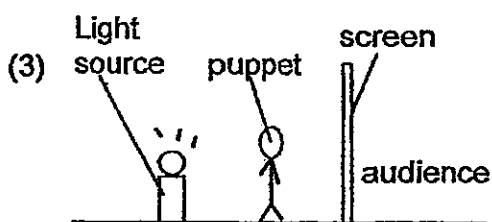
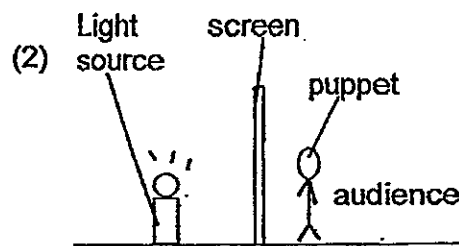
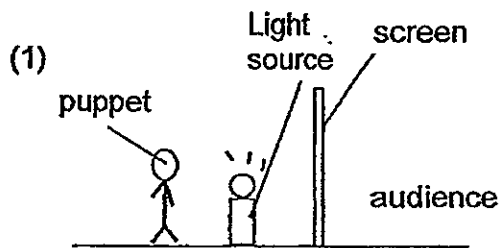

20. In which position must the sun be to cast the shadow as shown below?

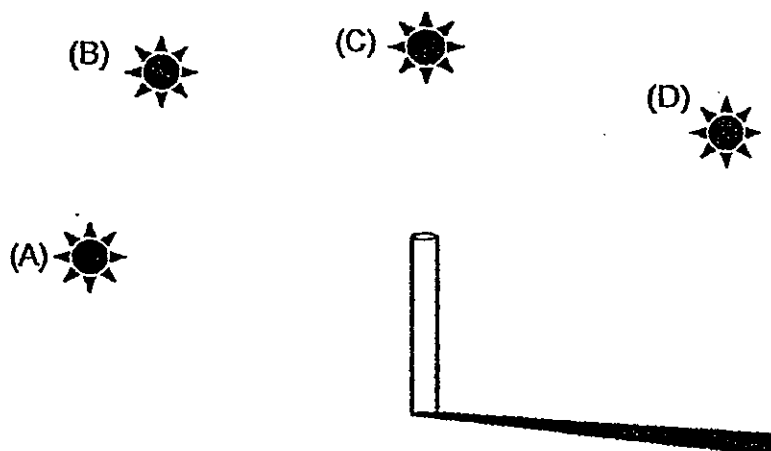

- (1) A
- (2) B
- (3) C
- (4) D

21. The experiment shown below is carried out by some pupils in a dark room.

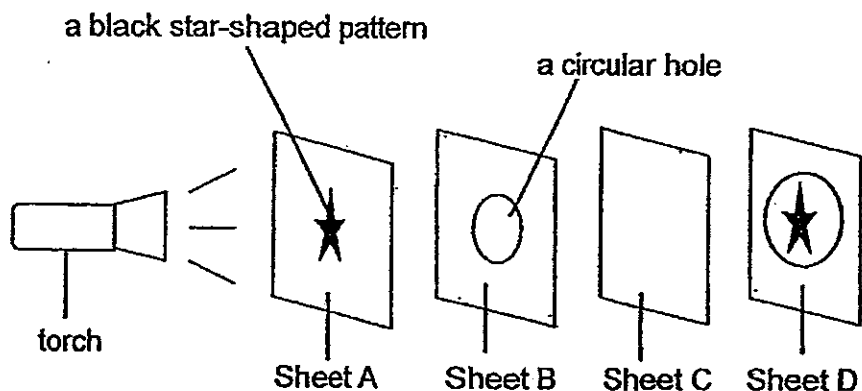

Sheets A, B, C and D are arranged in a straight line. A star-shaped pattern is painted black on Sheet A. A circular hole is cut out on Sheet B. When the torch is switched on, a bright patch of light with a star-shaped shadow is seen on Sheet D only.

Based on the above observation, which of the following would describe the degree of transparency to light of Sheets A, B, C and D?

	Made of transparent material	Made of opaque material	Not possible to tell
(1)	A and B	C and D	None
(2)	A and C	B and D	None
(3)	B and C	D only	A only
(4)	B only	A and C	D only

22. A glass of hot tea is put into a basin of cold water as shown in the diagram below.

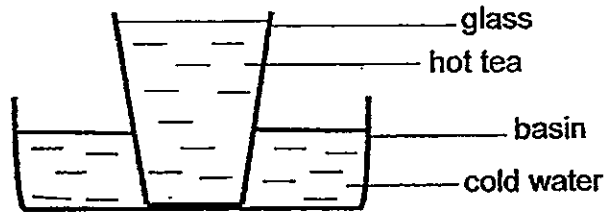

The line graph below shows the changes in the temperature of the hot tea.

Which of the graphs correctly represents the temperature changes of the hot tea after 1 hour?

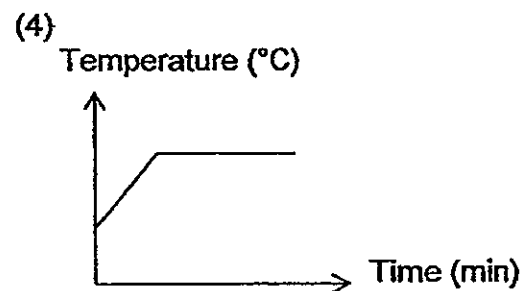
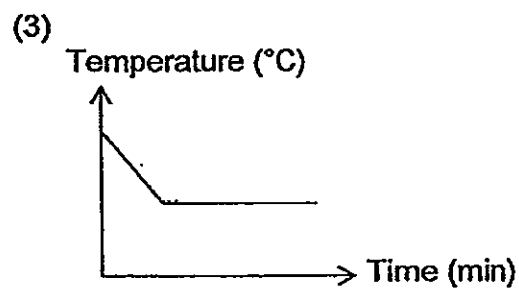
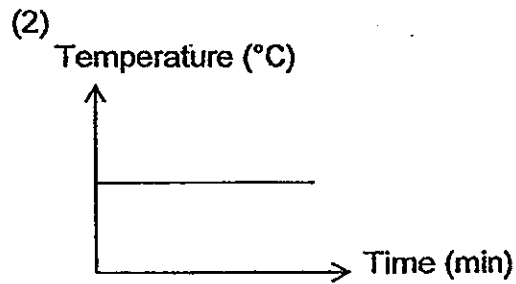
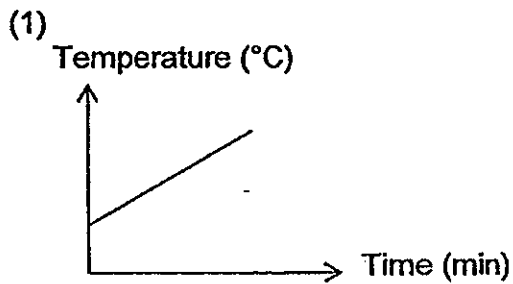

23. A bottle of milk at 30°C was placed in a basin of water as shown in the diagram below.

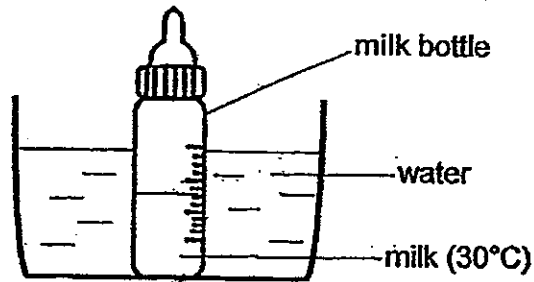

After 2 minutes, the temperature of the milk becomes 50°C .

What was the likely temperature of the water in the basin at first?

- (1) 10°C
 - (2) 30°C
 - (3) 50°C
 - (4) 80°C
24. Peter was at the train station. He observed that there are gaps along the train track as shown below.

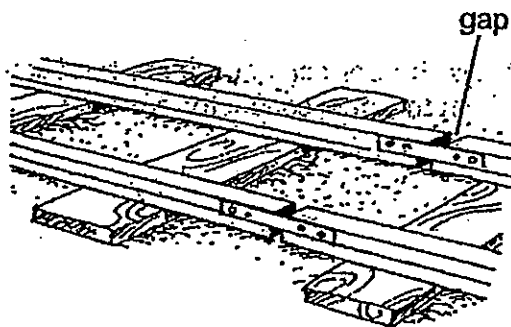

The purpose of having the gaps on the train tracks is to allow

-
- (1) the expansion of the track on hot days
 - (2) the expansion of the track on cold days
 - (3) the contraction of the track on hot days
 - (4) the contraction of the track on cold days

25. Rods P, Q and R were left in a beaker of hot water. A drop of wax was placed on each end of the rods as shown in the diagram below.

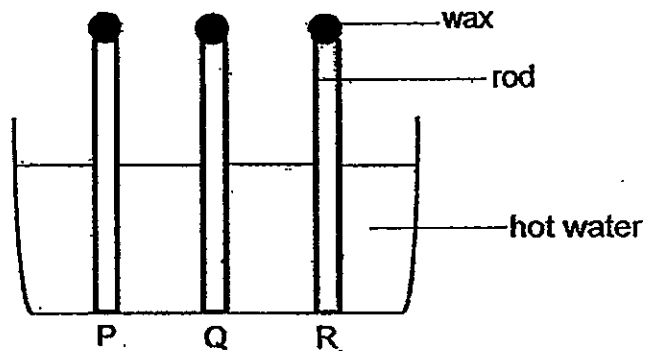

The time taken for the wax on the rods to melt was recorded in the table below.

Rod	Time taken for the wax to melt (s)
P	28
Q	115
R	54

Which of the following shows the correct order of the heat conductivity of rods P, Q and R starting from the best conductor of heat?

- (1) Q, R, P
- (2) P, R, Q
- (3) P, Q, R
- (4) R, P, Q

26. Timmy used magnet P for an experiment. Different parts of the magnet were labeled A, B and C as shown below.

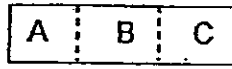

magnet P

He then used magnet P to move a toy car across a thin wooden surface as shown below.

Trial 1

Trial 2

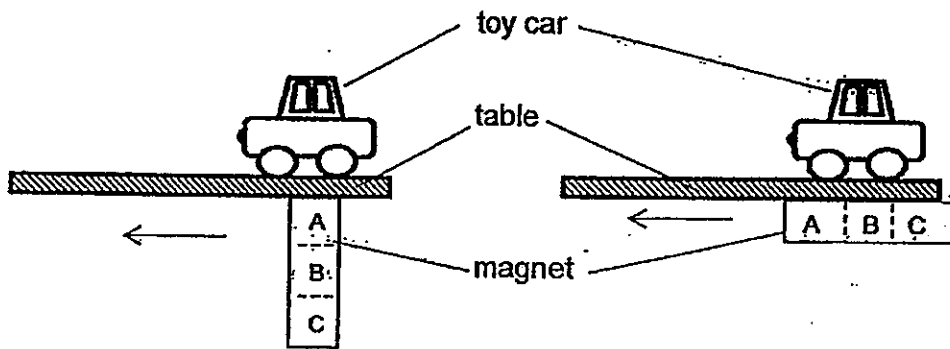

In which of the following trial 1 or 2 did the car move slower and what was the correct explanation for the observation?

	Trial	Explanation
(1)	1	Contact area between the car and the magnet is lesser.
(2)	1	Magnetism could not pass through wooden surface.
(3)	2	Part B of the magnet has a weaker magnetic force than part A.
(4)	2	Part B of the magnet has no magnetic force at all.

27. Hui Ling wanted to find out if the number of batteries used would affect the strength of the electromagnet. She used the set-up below to magnetize an iron nail.

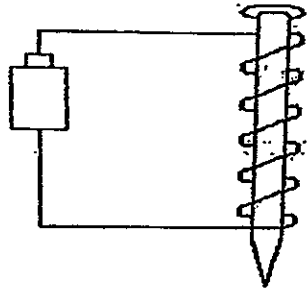

Which of the following graphs shows the correct results when Hui Ling carried out her experiment?

(1)

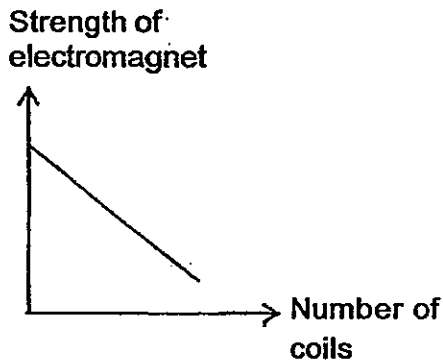

(2)

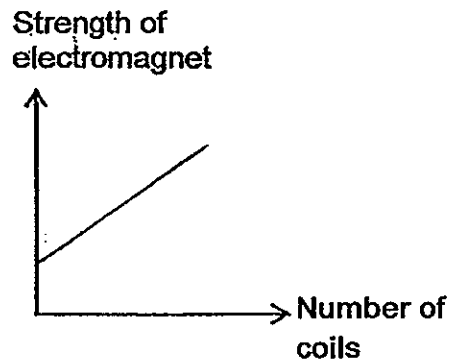

(3)

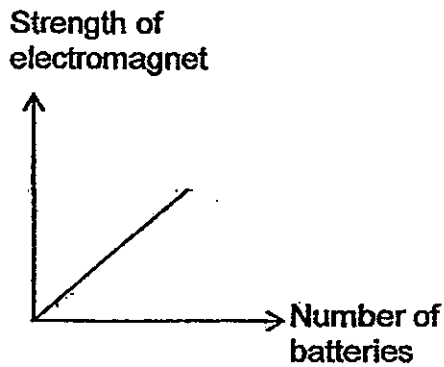

(4)

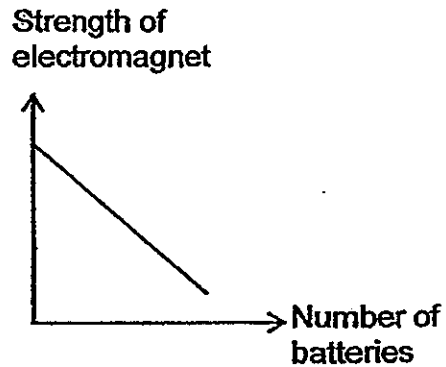

28. Kathy placed object A on the table top and moved a strong magnet towards it as shown in the diagram below.

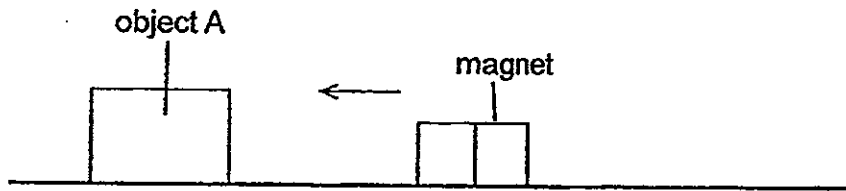

She repeated the experiment for objects B, C and D and recorded her results in the table below. A tick (✓) is used to show the observation that she had made for each object.

Objects	Moved towards the magnet	Did not move at all
A	✓	
B		✓
C	✓	
D	✓	

Which of the following objects had been correctly matched with the material it is made from?

	Object	Material
(1)	A	iron
(2)	B	steel
(3)	C	wood
(4)	D	aluminium

29. When object A is placed near point X of object B, object B moves towards it.

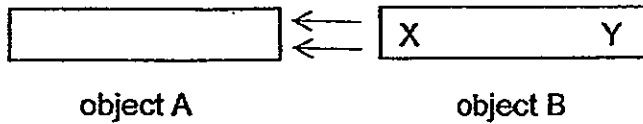

When object A is placed near point Y of object B, objects A and B move away from each other.

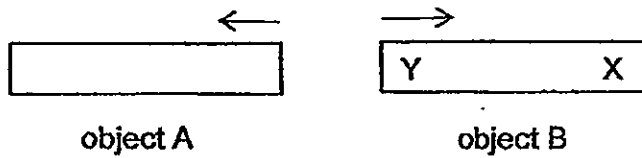

Which of the following statements are true about objects A and B?

- A Only object B is a magnet.
 - B Object B is made of a magnetic material.
 - C Both objects A and B are magnets.
 - D Object A is made of copper.
- (1) A and B only
(2) A and D only
(3) B and C only
(4) C and D only

30. Lynn placed a bar magnet above a steel paper clip tied to a weight by a string. The magnet pulled the paper clip up. She measured d_1 , the distance between the bar magnet and the paper clip.

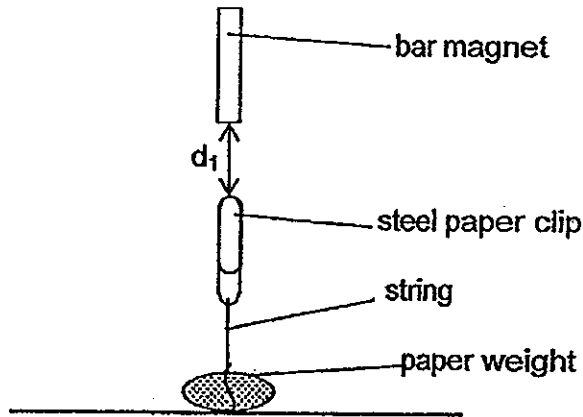

She then slowly moved the bar magnet away from the paper clip until the paper clip dropped.

Which of the following shows the relationship between the strength of the magnetic force exerted on the paper clip and d_1 ?

(1)

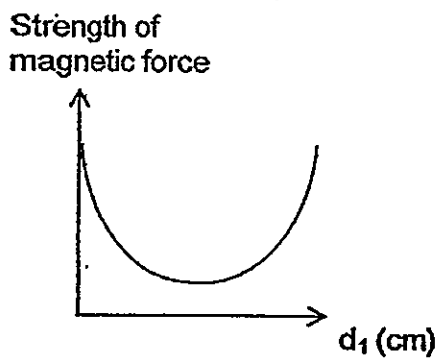

(2)

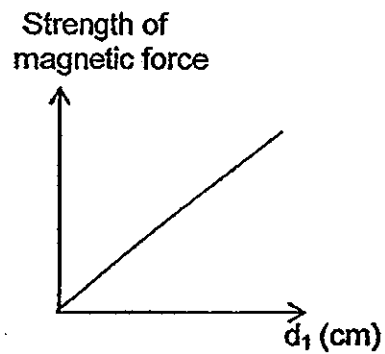

(3)

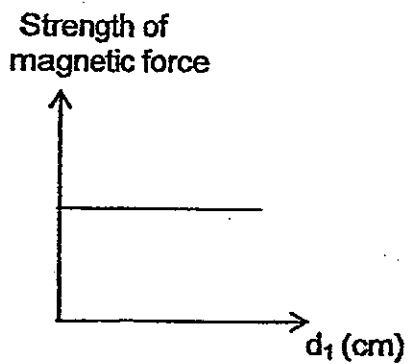

(4)

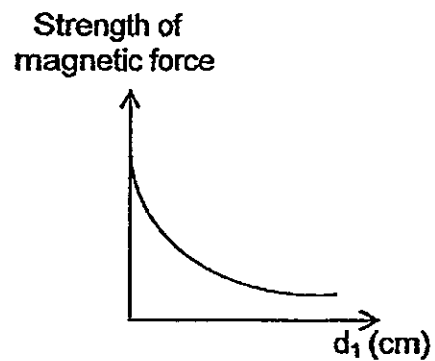

Name: _____ ()

_____/40

Class: 4 ()

Section B: 40 marks

Read the questions carefully and write down your answers in the spaces provided.

31. Draw lines to match the following animals to the correct groups. (3m)

Animals

Group

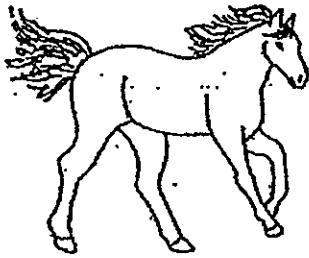

• mammal

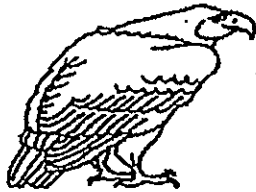

• insect

• bird



• fish

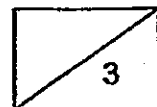

32. The diagram below shows a bottle of milk.

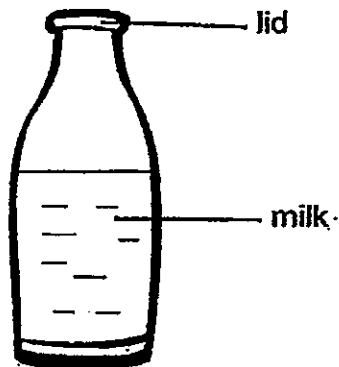

Complete the sentences to state if the parts are solid, liquid or gas. (2m)

(a) The cover is _____.

(b) Milk is a _____.

33. The diagram below shows how Mary sees the ball.

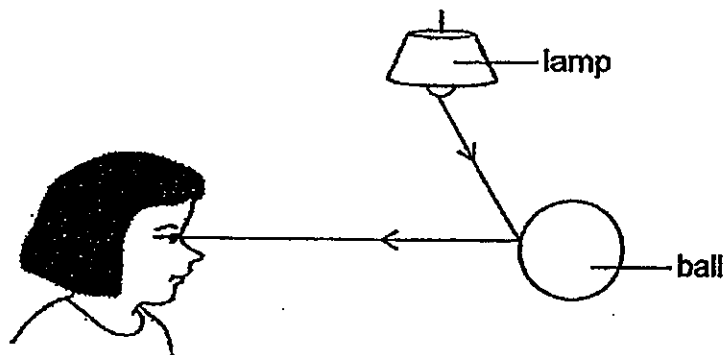

The _____ from the lamp is _____
by the ball and enters Mary's eye.

(2m)

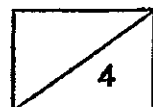

34. Jane used an instrument to measure the temperature of water in a glass.

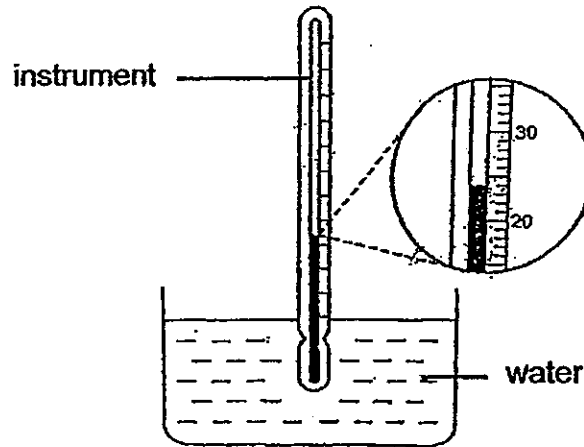

(a) What is the instrument called? (1m)

(b) What is the temperature of the water in the glass? (1m)

_____ °C

35.



Susan places a magnet near an iron rod. The iron rod moves towards the magnet.

(a) The magnet exerts a _____ on the iron rod. (1m)

(b) Choose the correct word from the box to answer the question below.



Susan's observation shows that iron is a _____ material. (1m)

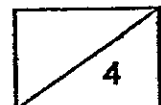

36. Write down 2 physical differences between plant A and plant B.

(2m)

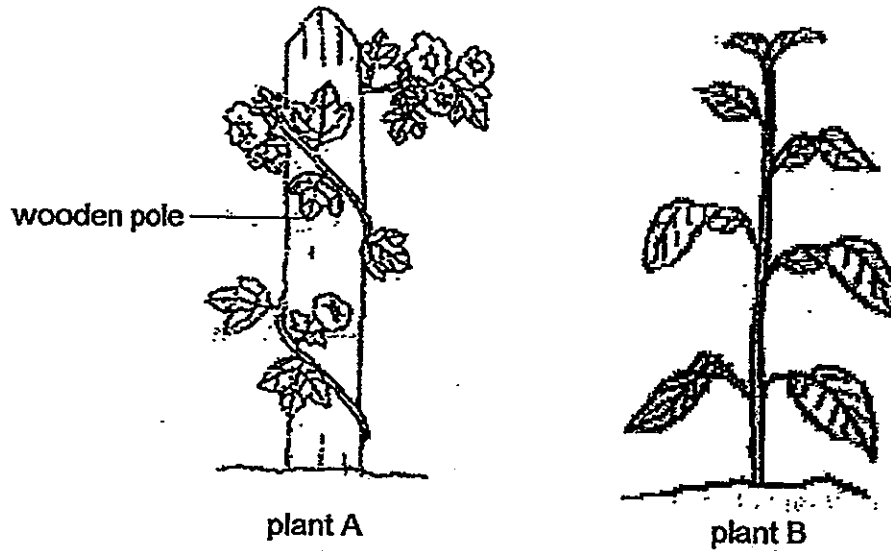

Difference 1: _____

Difference 2: _____

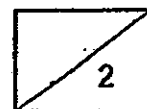

37. Max set up an experiment as shown in the diagram below. He placed the different set-ups A, B, C and D in different locations at different temperatures.

At the end of the experiment, it was observed that the seeds grew into seedlings in some set-ups but not in others.

Set-up A
Put under light (4°C)



Set-up B
Put in the dark (30°C)

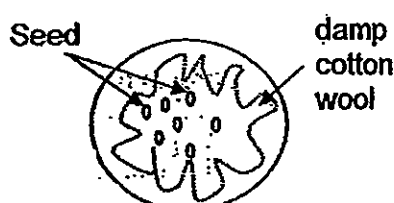

Set-up C
Put under light (30°C)



Set-up D
Put in the dark (4°C)



- (a) In which set-up A, B, C and/or D will the seedlings germinate?
Explain your answer. (2m)

- (b) What was Max trying to find out when he compared the following pairs of set-ups in his experiment? (2m)

Set-ups A and D

Set-ups A and C

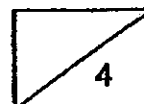

38. Ani carried out a scratch test on similar sized materials X, Y and Z. She used material X to scratch on Y and Z and noted the number of scratch marks made. She then repeated the experiment using Z. The results of her experiment are shown in the table below.

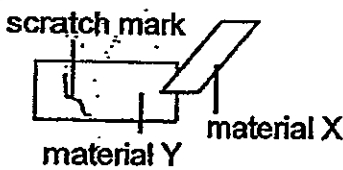
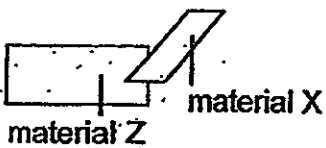
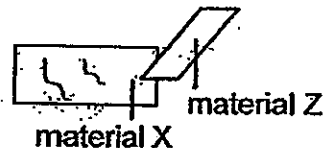
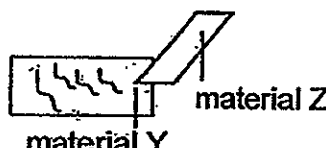
Observation	
 <p>scratch mark material Y material X</p>	 <p>material Z material X</p>
 <p>material X material Z</p>	 <p>material Y material Z</p>

- (a) Based on the results above, is material X or Z harder? Explain your answer. (1m)

- (b) Arrange the materials X, Y and Z according to the hardness. (1m)

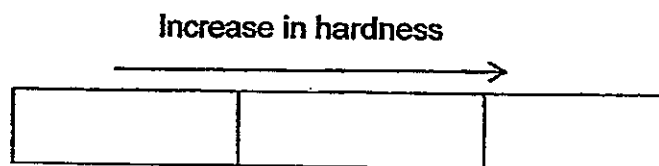

39. Ahmad set up an experiment to find out if the number of leaves a plant has affects the amount of water absorbed.

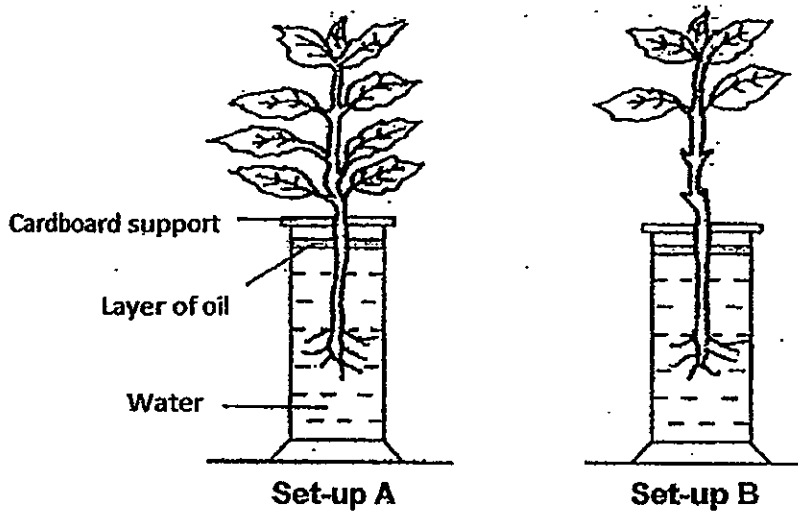

He recorded the amount of water left in the cylinder daily over a week. The results are shown in the graphs below.

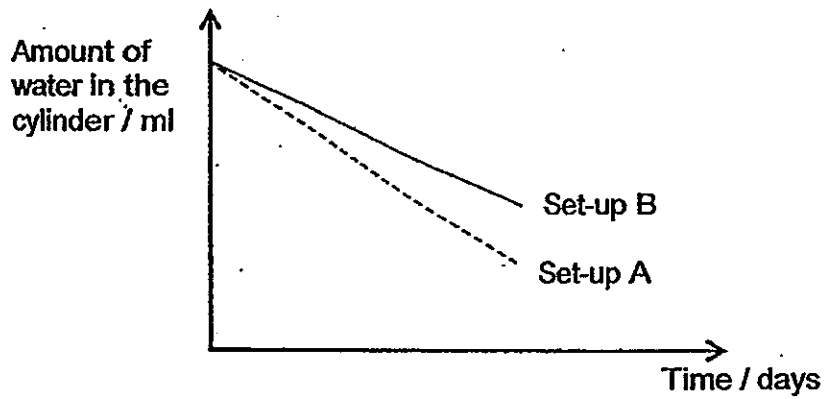

- (a) Did Ahmad conduct a fair test? Explain your answer. (2m)

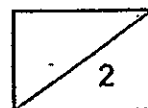

(b) In the space below, draw a line graph to show the relationship between the amount of water absorbed and the number of leaves a plant has. Label the axes. (2m)

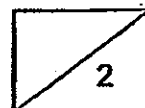
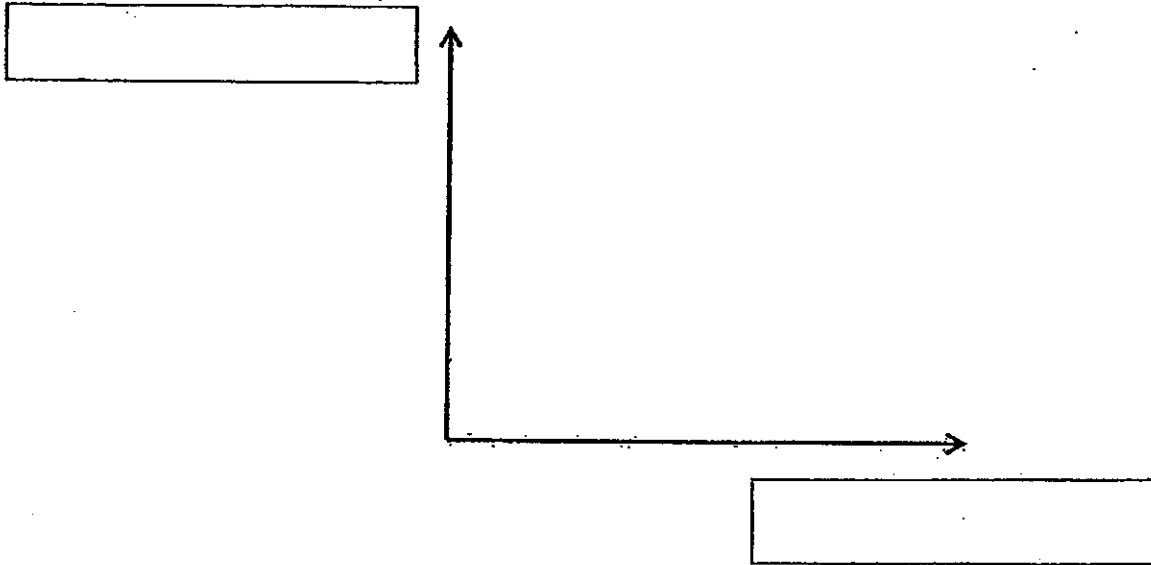

40. Ryan prepared 3 test-tubes filled with equal amounts of different liquids as shown below.

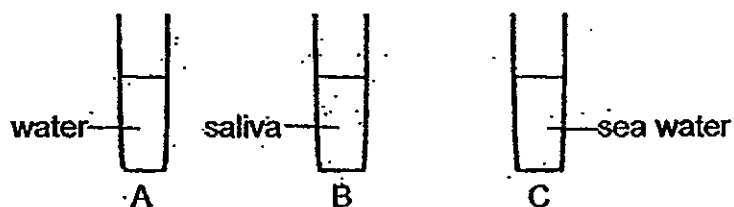

He then poured equal amounts of starch solution into the test-tubes. After 2 hours, he placed 2 drops of iodine into each test tube.

(Note: Iodine will turn from brown to dark blue in the presence of starch.)

- (a) Based on Ryan's experiment, what would his observation be when he placed iodine into test-tubes A and B? (2m)

Test-tube	Observation on the colour of iodine
A	
B	
C	dark blue

- (b) Explain Ryan's observation for the colour of iodine for test-tubes A and B. (2m)

Test-tube A: _____

Test-tube B: _____

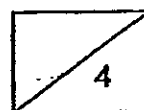

41. Ali has 3 empty containers, (A, B and C), of different sizes. He pumped 200 cm^3 of air into each container.

Container	Volume of container (cm^3)	Volume of air pumped into the container (cm^3)
A	100	200
B	200	200
C	300	200

- (a) In which container is the air compressed? Explain your answer. (1m)

- (b) Which property of air allows air to be compressed? (1m)

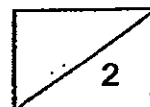

42. Kumar wanted to find out if darker colours reflect more or less light. He used the set-up below for his experiment.

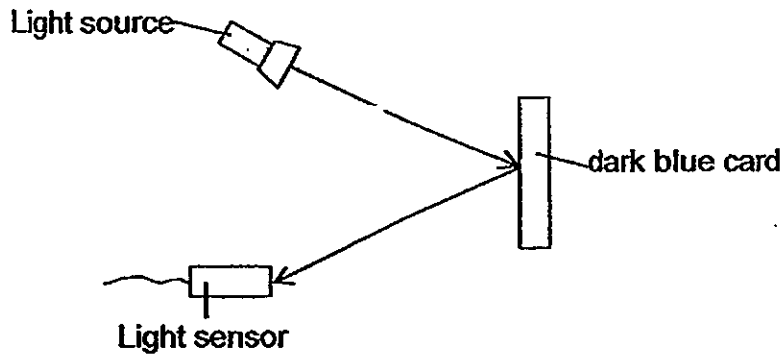

He shone the light source at a dark blue card and used the light sensor to record the amount of light reflected by the card. He repeated his experiment using light blue, dark orange and light orange cards and recorded his results as shown in the graph below.

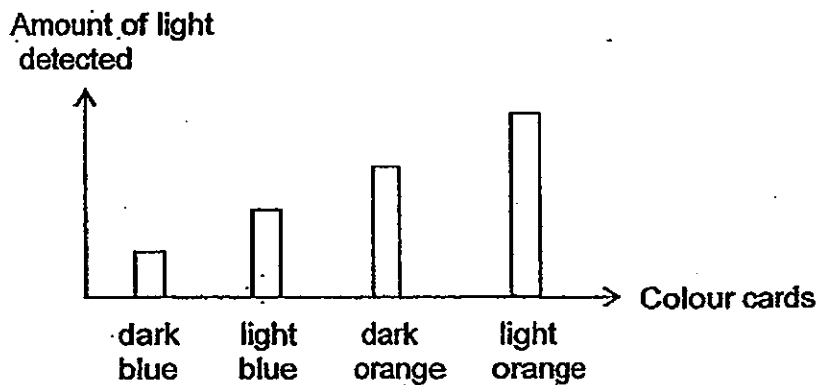

- (a) What can Kumar conclude from his experiment?

(1m)

- (b) Using the results obtained by Kumar, explain why wearing lighter colour clothing at night is safer for road users.

(2m)

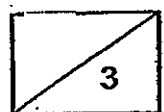

43.

(a)

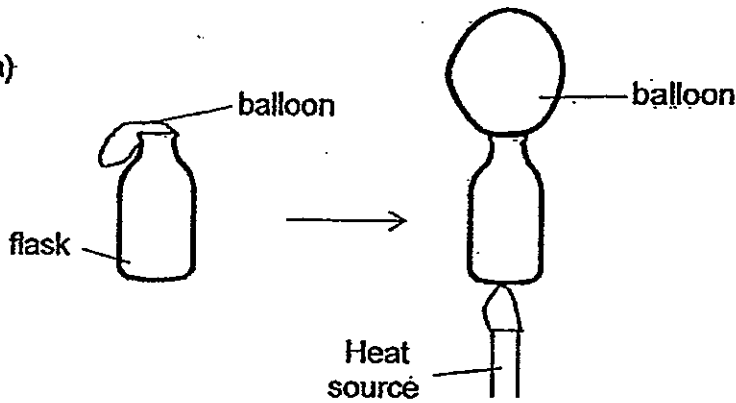

The balloon became inflated when the flask was heated. Explain why. (2m)

(b)

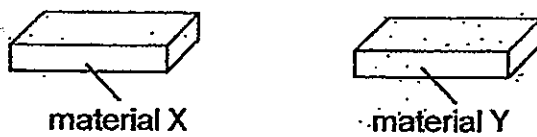

2 bars of chocolate of the same size are wrapped in different materials as shown above. It was observed that even though both bars of chocolates were placed in the same location, the chocolate wrapped in material Y melted faster than the one wrapped in material X. Suggest a reason for this observation. (2m)

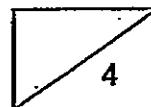

44. W, X, Y and Z are magnets of similar sizes hanging from two different lengths as shown below. A tray of paper clips is placed below and different number of paper clips is attracted to the magnets.

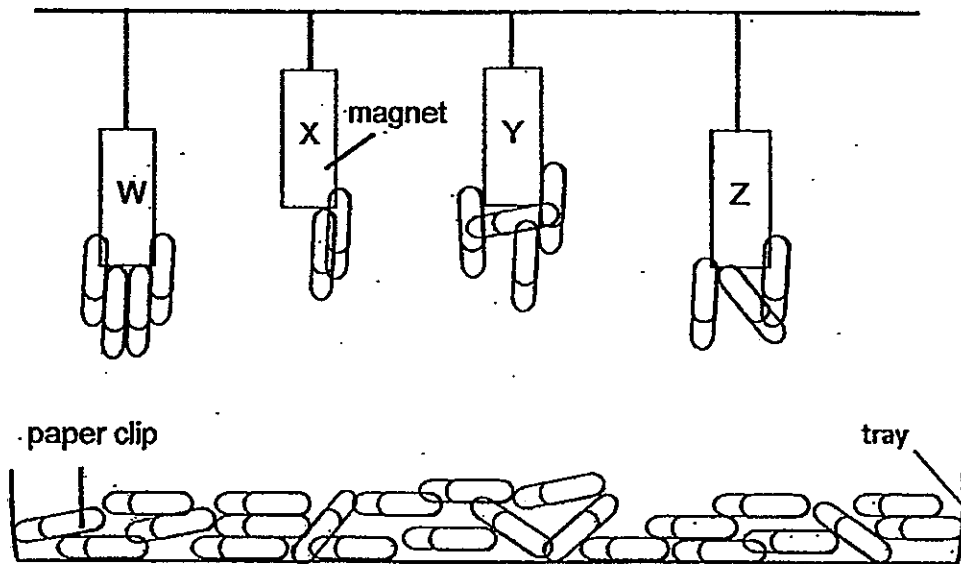

- (a) Which magnet, W, X, Y or Z is the strongest? Explain your answer. (1m)

- (b) Based on the diagram above, explain why it is difficult to compare the strengths of magnets X and Z. (2m)

- (c) Suggest a change that you could do to the set-up to make it a fair test. (1m)

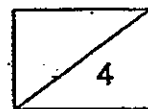

End of paper

ANSWER SHEET

EXAM PAPER 2013

SCHOOL : AI TONG

SUBJECT : PRIMARY 4 SCIENCE

TERM : SA2

Q1	Q2	Q3	Q4	Q5	Q6	Q7	Q8	Q9	Q10	Q11	Q12	Q13	Q14	Q15	Q16	Q17
4	3	4	1	3	3	2	4	3	3	1	3	3	3	2	1	3

Q18	Q19	Q20	Q21	Q22	Q23	Q24	Q25	Q26	Q27	Q28	Q29	Q30
1	3	2	2	3	4	1	2	3	3	1	3	4

Q31a) mammal, bird, fish

Q32a) solid

Q32b) liquid

Q33) The light from the lamp is reflected by object A and enters Mary's eye.

Q34a) thermometer

Q34b) 24°C

Q35a) magnetic force

Q35b) magnetic

Q36) Difference 1: Plant A has a weak stem while plant B has a strong stem.

Difference 2: Plant A has flowers but plant B does not.

Q37a) Set-ups B and C. In order for germination, air, water and warmth must be present and only set-ups B and C have air, water and warmth.

Q37b) Set-ups A and D: To find out if seeds need light to germinate.

Set-ups A and C: To find out if seeds need warmth to germinate.

Q38a) Material Z. When X scratched material Z, there were no scratch marks on Z.

Q38b)

Y	X	Z
---	---	---

Q39a) Yes. Only one variable was changed. He was able to compare and conclude that the amount of water absorbed is solely due to the number of leaves a plant has.

Q39b)

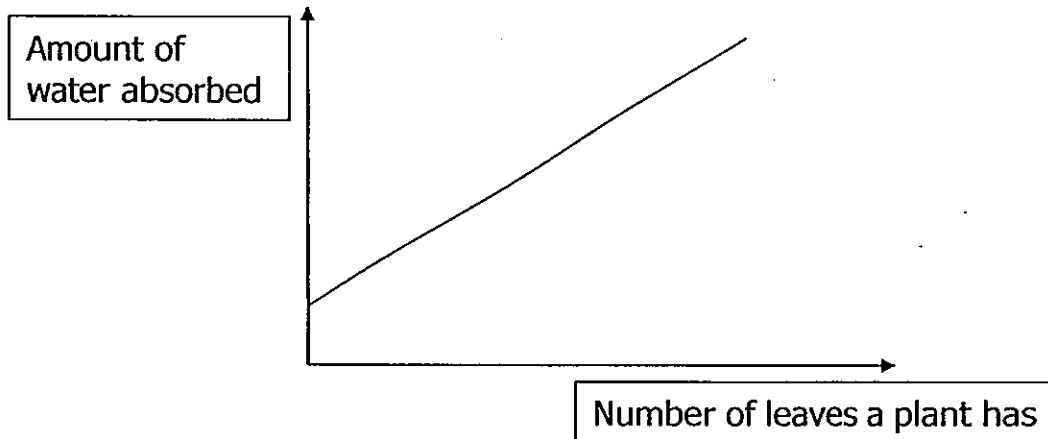

Q40a) A: dark blue

B: brown

Q40b) Test-tube A: Starch is present. Water cannot digest starch.

Test-tube B: Starch is not present. Saliva contains digestive juice which will digest the starch.

Q41a) Container A as the volume of container is smaller than the volume of air pumped in.

Q41b) Air does not have a definite volume.

Q42a) Darker colours can reflect lesser light than lighter colours.

Q42b) Lighter colours can reflect more light and drivers can see you more clearly.

Q43a) Air in the flask is heated. Air expands and occupies more space, entering the balloon and inflating it.

Q43b) Material Y is a better conductor of heat than X. Material Y conducts heat faster from the surroundings to the chocolate.

Q44a) Magnet Y is the strongest as it is the furthest from the paper clips, but it attracted the most number of paper clips.

Q44b) Although magnet X attracted lesser paper clips than magnet Z, it was hung further from magnet Z.

Q44c) Hang all the magnets at the same length.