



NAN HUA PRIMARY SCHOOL
SEMESTRAL ASSESSMENT 1 – 2013
PRIMARY 5

MATHEMATICS

Paper 1

Section A: 15 Multiple Choice Questions (20 marks)

Section B: 15 Short Answer Questions (20 marks)

Total Time for Paper 1: 50 minutes

INSTRUCTION TO CANDIDATES

1. Write your name and index number in the space provided.
2. Do not turn over the page until you are told to do so.
3. Follow all instructions carefully.
4. Answer all questions.
5. Shade your answers in the Optical Answer Sheet (OAS) provided for Questions 1-15.
6. You are not allowed to use calculator for Paper 1.

Marks Obtained

Paper 1	Booklet A		/ 40
	Booklet B		
Paper 2			/ 60
Total			/ 100

Name : _____ ()

Class : 5 _____

Date : 16 May 2013

Parent's Signature: _____

Section A (20 marks)

Questions 1 to 10 carry 1 mark each. Questions 11 to 15 carry 2 marks each.
For each question, four options are given. One of them is the correct answer.
Make your choice (1, 2, 3 or 4) and shade on the oval (1, 2, 3 or 4) on the Optical Answer Sheet.

1. In 206.594, what does the digit 9 stand for?

- (1) 9 thousandths
- (2) 9 hundredths
- (3) 9 tenths
- (4) 9 ones

2. Express $1\frac{9}{12}$ as a decimal.

- (1) 1.812
- (2) 1.75
- (3) 1.34
- (4) 1.25

3. What is the missing number in the box?

$$\frac{24}{40} = \frac{30}{\boxed{}}$$

- (1) 34
- (2) 46
- (3) 50
- (4) 54

4. How many sixths are there in $3\frac{2}{3}$?

- (1) 11
- (2) 13
- (3) 20
- (4) 22

5. In a container of 60 beads, 28 of them are red, 12 are green and the rest are blue. What is the ratio of the number of blue beads to the number of red beads to the total number of beads?

- (1) 7 : 5 : 15
- (2) 5 : 7 : 15
- (3) 7 : 3 : 5
- (4) 5 : 7 : 3

6. The diagram below is not drawn to scale. Find the area of the shaded triangle ABD.

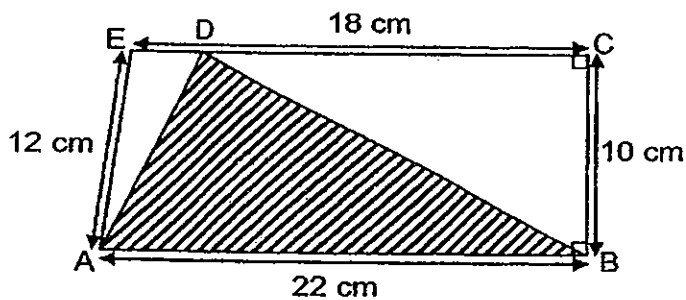





- (1) 90 cm²
- (2) 108 cm²
- (3) 110 cm²
- (4) 132 cm²

7. $12 = \frac{\square}{\square}$ of 60. The missing fraction is _____.

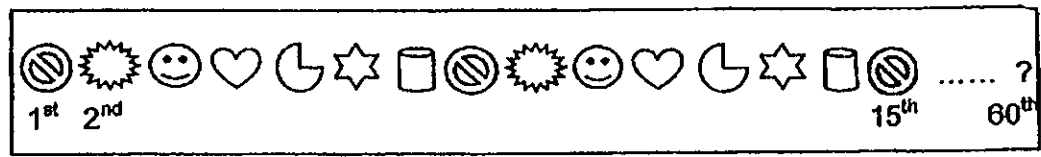
- (1) $\frac{1}{4}$
- (2) $\frac{1}{5}$
- (3) $\frac{1}{6}$
- (4) $\frac{1}{12}$

8. Study the following pattern carefully. The first 15 shapes are shown. What is the 60th shape in the pattern?



- (1) 
- (2) 
- (3) 
- (4) 

9. What is the value of $360 - (24 - 2 + 8) \times 3$?
- (1) 270
 - (2) 318
 - (3) 358
 - (4) 990
10. When a number is divided by 8, it gives a quotient of 96 and a remainder of 6. What is the number?
- (1) 720
 - (2) 762
 - (3) 768
 - (4) 774
11. Brian is 10 years old now. His mother is 4 times as old. What was the ratio of his mother's age to his age 5 years ago?
- (1) 1 : 4
 - (2) 2 : 5
 - (3) 3 : 1
 - (4) 7 : 1
12. Joan had $\frac{7}{8}$ kg of sugar. She used $\frac{1}{3}$ of the sugar to bake some cakes. What was the mass of the sugar that was left?
- (1) $\frac{1}{24}$ kg
 - (2) $\frac{5}{12}$ kg
 - (3) $\frac{7}{12}$ kg
 - (4) $\frac{7}{24}$ kg

13. Ali's cards is equal to $\frac{1}{5}$ of Rahma's cards. If Ali has 60 cards, how many cards does Rahma have?
- (1) 12
 - (2) 48
 - (3) 240
 - (4) 300
14. A case can either hold 24 identical pens or 18 identical crayons. If there are already 8 such pens in the case, what is the greatest number of crayons that can be placed in the remaining space in the case?
- (1) 10
 - (2) 12
 - (3) 14
 - (4) 16
15. Krishnan gave away $\frac{1}{6}$ of her stickers and had 300 stickers left. How many stickers did she give away?
- (1) 50
 - (2) 60
 - (3) 240
 - (4) 250

Section B (20 marks)

Questions 16 to 25 carry 1 mark each. Write your answers in the spaces provided. For questions which require units, give your answers in the units stated.

16. Write four million and fifteen thousand in numeral.

Ans: _____

17. Express $6\frac{4}{25}$ as a decimal and correct to 1 decimal place.

Ans: _____

18. What is the missing number in the box in the following equivalent ratio.

$$18 : 72 = \boxed{} : 9$$

Ans: _____

19. $\frac{5}{8}$ of the pupils in a choir are girls. Find the ratio of the number of boys to the number of girls in the choir.

Ans: _____

/4

20. A square table can seat 4 people as shown below. John joins some identical square tables together to form a long rectangular table in order to seat 24 people. Find the least number of such square tables he needs?

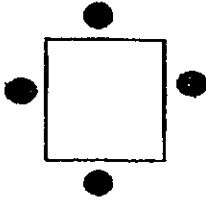

Ans: _____ square tables

21. What is the missing number in the box?

$$9 \times 160 = \boxed{} \times 160 - 160$$

Ans: _____

22. Find the sum of 0.75 and 10.6.
Express your answer as a mixed number in the simplest form.

Ans: _____

$\boxed{} / 3$

23. Express 40 cm as a fraction of 0.5 m. Give your answer in the simplest form.

Ans: _____

24. Using the number cards provided below, form the greatest 4-digit odd number that is divisible by 9. Each digit can only be used once.

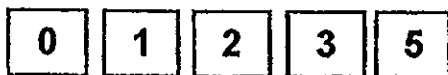

Ans: _____

25. 10 jugs of water can fill $\frac{5}{6}$ of a tank. Exactly how many such jugs of water are required to fill the whole tank?

Ans: _____

/3

Questions 26 to 30 carry 2 marks each. Show your working clearly in the space provided for each question and write your answers in the spaces provided. For questions which requires units, give your answers in the units stated.

26. The number of cars to the number of vans to the number of motorcycles in a car park was 15 : 3 : 7. There were 96 more cars than motorcycles. How many vans were there in the car park?

Ans: _____ vans

27. Victoria had $\frac{2}{5}$ as much money as Dora at first. When Dora gave \$36 to Victoria, they had the same amount of money. How much money did both of them have altogether?

Ans: \$ _____

28. Vincent drew 5 different equilateral triangles as shown below. If point A to point B measures 20 cm, find the sum of the perimeters of the 5 triangles.

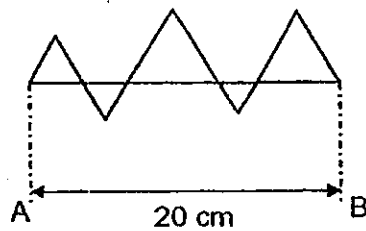

Ans: _____ cm

/6

29. Kent is between 10 and 30 years old. In the year 2013, his age is a multiple of 4. In the year 2014, his age is a multiple of 7. What was his age in year 2012?

Ans: _____

30. The figure below is made up of 5 identical squares. The area of the figure is 45 cm^2 . Find the perimeter of the figure.

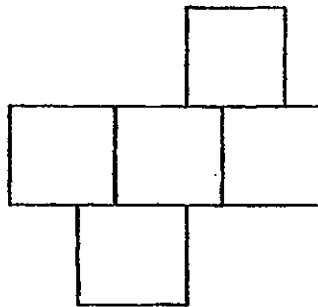

Ans: _____ cm

$\frac{1}{4}$

END OF PAPER 1



**NAN HUA PRIMARY SCHOOL
SEMESTRAL ASSESSMENT 1 – 2013
PRIMARY 5**

MATHEMATICS

Paper 2

Total Time for Paper 2: 1 hour 40 minutes

5 Short Answer Questions (10 marks)

13 Structured / Long Answer Questions (50 marks)

INSTRUCTIONS TO CANDIDATES

- 1. Write your name and index number in the space provided.**
- 2. Do not turn over the page until you are told to do so.**
- 3. Follow all instructions carefully**
- 4. Answer all questions and show your workings clearly.**
- 5. You are allowed to use a calculator.**

Marks Obtained

Total		/ 60
--------------	--	-------------

Name : _____ ()

Class : 5 _____

Date : 16 May 2013 Parent's Signature : _____

Paper 2 (60 marks)

Questions 1 to 5 carry 2 marks each. Show your workings clearly in the space below it and write your answer in the space provided. Give your answers in the units stated.

1. A shirt and a blouse cost \$25. Ashley paid \$36 for 2 such shirts and 1 such blouse. What was the cost of each blouse?

Ans: \$ _____

2. The area of the shaded part of the rectangle ABCD is 450 cm^2 . What is the area of the rectangle ABCD.

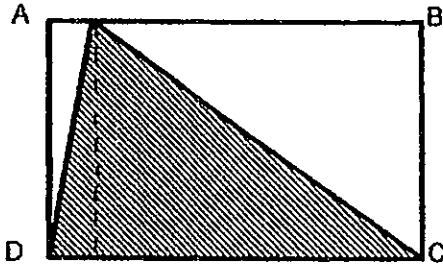

Ans: _____ cm^2

3. Audrey bought $3\frac{1}{10} \ell$ of lemonade and Ben bought $\frac{3}{5} \ell$ less lemonade than Audrey. How much lemonade did they buy altogether? Give your answer as a mixed number in the simplest form.

Ans: _____ ℓ

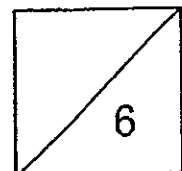

4. Alden placed some identical wooden poles along a straight path that was 6 m long. He placed the poles at equal distance apart with a pole at each end of the track. The distance between the first pole and the sixth pole was 60 cm. How many wooden poles did Alden place along the straight path altogether?

Ans: _____

5. Shade two more squares to make the figure symmetrical along the line AB.

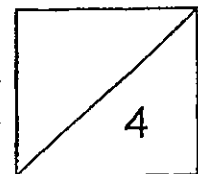
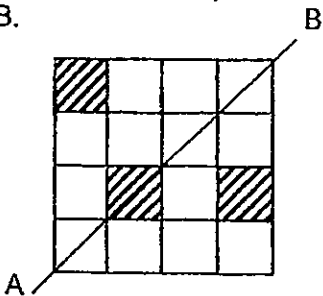

For questions 6 to 18, show your working clearly in the space provided for each question and write your answers in the spaces provided. The number of marks available is shown in brackets [] at the end of each question or part-question.

6. Alycia spent $\frac{2}{5}$ of her money on some pizzas and $\frac{1}{6}$ of the remaining on some pies.

- (a) What fraction of her money did she spend on the pies?
- (b) If she was left with \$25, how much did she spend on the pizzas?

Ans: (a) _____ [1]

(b) _____ [2]

7. At a concert performance, the ratio of the number of adults to the number of boys to the number of girls was 3 : 5 : 4. There were 774 children.

- (a) How many adults were there?
- (b) What was the ratio of the number of adults to the number of children? Give your answer in the simplest form.

Ans: (a) _____ [2]

(b) _____ [1]

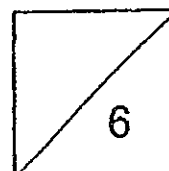

8. David and Peter shared a sum of money. After David gave \$15 to Peter he still had \$10 more than Peter. How much more money did David have than Peter at first?

Ans: _____ [3]

9. There were thrice as many girls as boys in the school hall. After 36 girls had left the hall the number of boys and the number of girls that remained in the hall were equal. How many children were there in the school hall at first?

Ans: _____ [3]

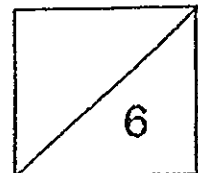

10. Betty had some beads. She gave Tricia $\frac{1}{5}$ of the beads and 2 more. Then she gave half of the remaining and 5 more to Lovell. If Betty had 12 beads left, how many beads did she have at first?

Ans: _____ [4]

11. Miss Lam bought a bag of sweets to give to a group of pupils. If each pupil received 7 sweets, Miss Lam would have 5 sweets left. If each pupil received 9 sweets, she would be short of 3 sweets.
- (a) How many pupils were there?
- (b) How many sweets did Miss Lam buy?

Ans: (a) _____ [1]

(b) _____ [2]

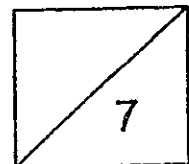

12. Anthony attempted a Mathematics quiz that consisted of 20 questions. 5 marks were awarded for every question that was answered correctly and 2 marks were deducted for every question that was answered wrongly. Anthony did all the questions and was awarded 65 marks. How many questions did Anthony answer correctly?

Ans: _____ [4]

13. Derrick, Nicole and Ashton had 260 marbles to share among themselves in the ratio of 2 : 3 : 5. How many marbles must Ashton give to Derrick so that both of them would have the same number of marbles?

Ans: _____ [4]

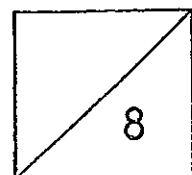

14. James spent $\frac{3}{4}$ of his money on a book and $\frac{2}{3}$ of the remainder on a pen. He had \$1.25 left.

- (a) What fraction of his money did he spend altogether?
- (b) How much money did he have at first?

Ans: (a) _____ [2]

(b) _____ [2]

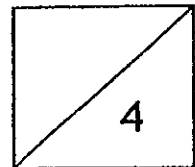

15. Study the table and pattern carefully and answer the questions that follow.

Pattern 1



Pattern 2

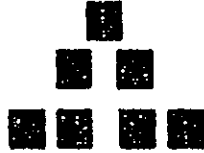

Pattern 3



Pattern number	Number of squares
Pattern 1	3
Pattern 2	7
Pattern 3	13
Pattern 4	21
...	...
Pattern 30	(a) _____

(a) Complete the table above.

(b) How many squares will Pattern 90 have?

Ans: (a) _____ [2]

(b) _____ [2]

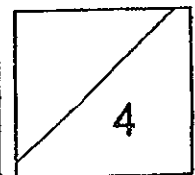

16. The figure below is made up of a triangle of base 60 cm overlapping with a rectangle of length 40 cm and breadth 30 cm. The area of the shaded part is $\frac{2}{5}$ of the area of the triangle. What fraction of the figure is shaded? Express your answer in the simplest form.

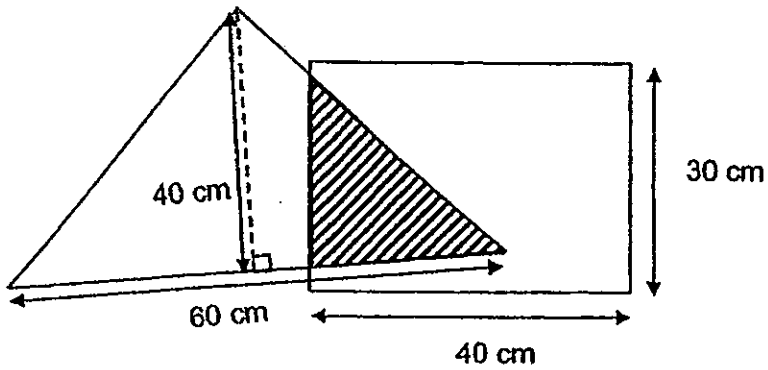

Ans: _____ [5]

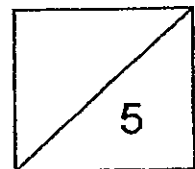

17. In a funfair, $\frac{5}{6}$ of the people were children and the rest were adults. $\frac{1}{3}$ of the adults were women. $\frac{2}{3}$ of the children were girls. If there were 869 women and girls altogether, how many boys were there at the funfair?

Ans: _____ [5]

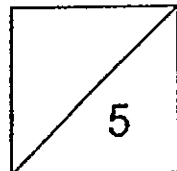

18. Roy's coin box contained the same number of ten-cent coins and fifty-cent coins. He took out 20 ten-cent coins and exchanged them for fifty-cent coins of the same value and put them back into the coin box. The ratio of the number of fifty-cent coins to the number of ten-cent coins became $17 : 5$. How much money was there in the coin box?

Ans: _____ [5]

END OF PAPER 2

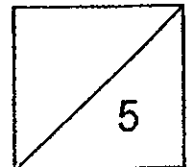



ANSWER SHEET

EXAM PAPER 2013

SCHOOL : NAN HUA PRIMARY SCHOOL
LEVEL : PRIMARY 5
SUBJECT : MATHEMATICS
TERM : SA1

Booklet A

Q1	Q2	Q3	Q4	Q5	Q6	Q7	Q8	Q9	Q10	Q11	Q12	Q13	Q14	Q15
2	2	3	4	2	3	2	1	1	4	4	3	4	2	2

16. 4015000

17. 6.2

18. 2

19. 3:5

20. 11

21. 10

22. $11\frac{17}{20}$

23. $\frac{4}{5}$

24. 5301

25. 12

26. 36

27. 168

28. 60

29. 19

30. 36

Paper 2

1. $36-255=11$

1S --- 11

1B --- $25-11 = 14$

2. $450 \times 2 = 900$

3.

$$3\frac{1}{10} - \frac{6}{10} \div \frac{31}{10} = \frac{56}{10} = 5\frac{3}{5}$$

4. $6-1=5$

$60 \div 5 = 12$

$600 \div 12 = 50$

$50 + 1 = 51$

5. .

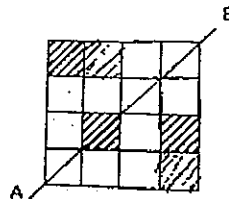

6.A.

b. $25 \div 5 = 5$

1u --- 5

4u --- 20

7. A. $5 + 4 = 9$

$774 \div 4 = 86$

1u --- 86

3u --- $86 \times 3 = 258$

b. A:C

3:9

1:3

8. $15 + 15 + 10 = 40$

9. 2u --- 36

1u --- 18

4u --- 72

10. $12 + 5 = 17$

$17 \times 2 = 34$

$34 + 2 = 36$

$36 \div 2 \times 3 = 54$

11. A. $9 - 7 = 2$

$3 + 5 = 8$

$8 \div 2 = 4$

B. $4 \times 7 + 5 = 33$

$4 \times 9 - 3 = 33$

12. $5 + 2 = 7$

$20 \times 5 = 100$

$100 - 65 = 35$

$35 \div 7 = 5$

$20 - 5 = 15$

13. D:N:A

2:3:5

4:6:10

$4 + 6 + 10 = 20$

$260 \div 20 = 13$

1u --- 13

3u --- 39

14. A. $1 - 1/12 = 11/12$

b. $1.25 \times 12 = 15$

15. A. $30 \times 30 = 900$

$900 + 30 + 1 = 931$

B. $90 \times 90 = 8100$

$8100 + 90 + 1 = 8191$

16. $40 \times 30 = 1200$

$3/5 \times 1200 = 480$

$1200 - 480 = 720$

$1200 + 720 = 1920$

$480 / 1920 = 1/4$

17. $10 + 1 = 11$

11u --- 869
1u ---- 79
5u --- 395

18.20x10cents = \$2
\$2÷50cents = 4
12u ---- 20+4 = 24
1u --- 2
5u --- 10
10x10cent + 34x50cents = 18

