



NAN HUA PRIMARY SCHOOL
SEMESTRAL ASSESSMENT 2 – 2013
PRIMARY 5

MATHEMATICS

Paper 1

Section A: 15 Multiple Choice Questions (20 marks)

Section B: 15 Short Answer Questions (20 marks)

Total Time for Paper 1: 50 minutes

INSTRUCTION TO CANDIDATES

1. Write your name and index number in the space provided.
2. Do not turn over the page until you are told to do so.
3. Follow all instructions carefully.
4. Answer all questions.
5. Shade your answers in the Optical Answer Sheet (OAS) provided for Questions 1-15.
6. You are not allowed to use calculator for Paper 1.

Marks Obtained

Paper 1	Booklet A		/ 40
	Booklet B		
Paper 2			/ 60
Total			/ 100

Name : _____ ()

Class : 5 _____

Date : 28 October 2013

Parent's Signature : _____

Section A (20marks)

Questions 1 to 10 carry 1 mark each.

Questions 11 to 15 carry 2 marks each.

For each question, four options are given. One of them is the correct answer.

Make your choice (1, 2, 3 or 4). Shade the oval (1, 2, 3 or 4) on the Optical Answer Sheet.

1. Round off 936 725 to the nearest thousands.

(1) 936 730

(2) 937 000

(3) 940 000

(4) 900 000

2. What is the value of $(8 + 5) + 9 \times 7 - 2$?

(1) 58

(2) 74

(3) 110

(4) 152

3. A pond holds 600 litres of water. How many 500-ml bottles of water can be filled using all the water from the pond?

(1) 12

(2) 120

(3) 1200

(4) 12000

4. $\frac{5}{7} - \frac{2}{3} =$

(1) $\frac{1}{21}$

(2) $\frac{3}{21}$

(3) $\frac{10}{21}$

(4) $\frac{13}{21}$

5. ABCD is a rectangle. BC is 30 cm and CD is 11 cm. S is in the middle of AD. Find the area of the shaded triangle APS. (Diagram not drawn to scale.)

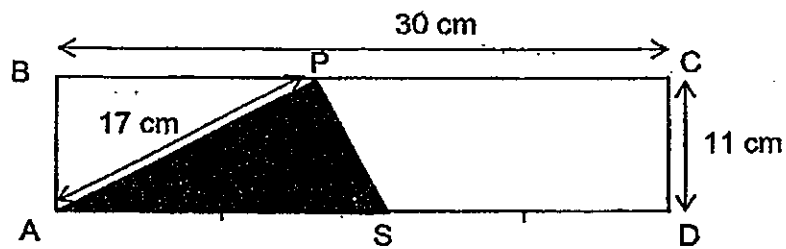

(1) 82.5 cm²

(2) 93.5 cm²

(3) 165 cm²

(4) 330 cm²

6. Jeffrey has 5 times as many stickers as Shawn. What is the ratio of the number of stickers that Jeffrey has to the total number of stickers that Jeffrey and Shawn have?

(1) 1 : 5

(2) 5 : 1

(3) 5 : 6

(4) 6 : 5

7. At a fun race, $\frac{5}{8}$ of the participants are adults and the rest are children.

$\frac{2}{3}$ of the children are boys. What fraction of the participants are girls?

(1) $\frac{1}{8}$

(2) $\frac{1}{4}$

(3) $\frac{5}{24}$

(4) $\frac{5}{12}$

8. Mr Tan is 8 years older than his wife. In 5 years' time, he will be 57 years old. How old is his wife now?

(1) 44

(2) 49

(3) 52

(4) 54

9. Mr Raju mixed 1.2 l of orange syrup with 8 times as much water. The mixture is then poured equally into 6 glasses. How many litres of mixture does each glass contain?

(1) 1.2 l

(2) 1.4 l

(3) 1.6 l

(4) 1.8 l

10. The number of children who come to school by bus, MRT and car is in the ratio 2 : 5 : 9 respectively. If there are 24 more children who come to school by MRT than by bus, find the number of children who come to school by car.

(1) 30

(2) 40

(3) 54

(4) 72

11. A box contains red and yellow marbles. 40% of the marbles are red. There are 72 yellow marbles. How many marbles are there altogether in the box?

(1) 48

(2) 108

(3) 120

(4) 180

12. In the figure shown below, not drawn to scale, $AD = BD = CD$. Find $\angle ABD$.

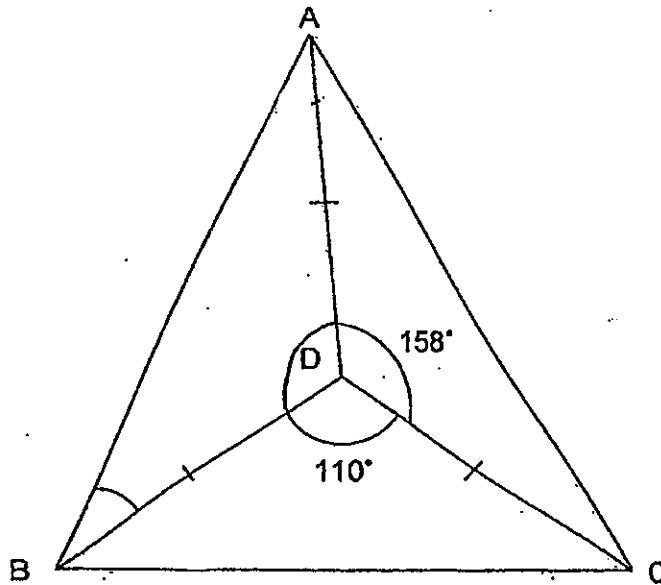

- (1) 11°
(2) 35°
(3) 44°
(4) 92°
13. Mandy bought some roses and tulips for \$68. She bought more roses than tulips and paid \$12 more for those additional roses. If a rose and a tulip cost \$4, how many tulips did she buy?
- (1) 7
(2) 14
(3) 17
(4) 20

14. Kevin jogged a distance of 1.75 km on the first day and a distance of 2 km on the second day. The average distance he jogged for 3 days is 1.8 km. What is his jogging distance for the third day?

(1) 1.65 km

(2) 1.75 km

(3) 1.85 km

(4) 1.95 km

15. The pattern below is formed with the letters A, B, C and D.

A B C D C B A B C D C B A B C D

What is the 247th letter in the pattern?

(1) A

(2) B

(3) C

(4) D

Section B (20 marks)

Questions 16 to 25 carry 1 mark each. Write your answers in the spaces provided. For questions which require units, give your answers in the units stated. [10 marks]

16. In $14 : 21 : 28 = 16 : \underline{\hspace{1cm}} : 32$, what is the missing number?

Ans: _____

17. Kelly had a roll of ribbon which was 5 m long. She cut them into smaller pieces of $\frac{1}{4}$ m each. How many smaller pieces of ribbon did she have?

Ans: _____

18. What is the total area of the shaded triangles? (Diagram is not drawn to scale.)

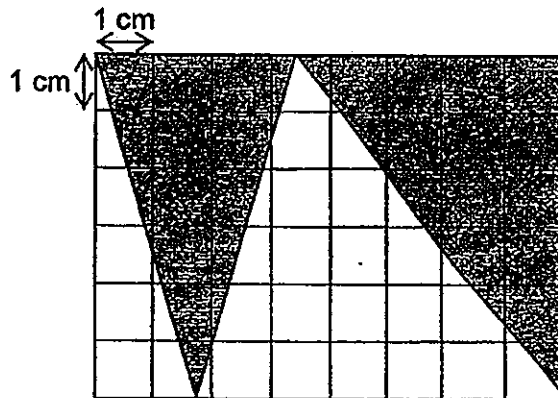

Ans: _____ cm²

Do not write
in this space

Do not write
in this space

19. The table below shows the number of tickets sold by 5 pupils for a carnival. How many pupils sold fewer than 35 tickets?

Pupil	Andy	Barry	Calvin	Daisy	Eunice
Number of tickets	37	35	34	32	35

Ans: _____

20. A handbag costs \$160 after a discount of 20%. What is the original price of the bag?

Ans: \$ _____

21. A stick measures 21cm when rounded off to the nearest centimetres. What is the longest possible length of the stick? Give your answer correct to 2 decimal places.

Ans: _____ cm

The bar graph below shows the number of stamps collected by 4 boys. Study the graph carefully and answer questions 22 and 23.

Do not write in this space

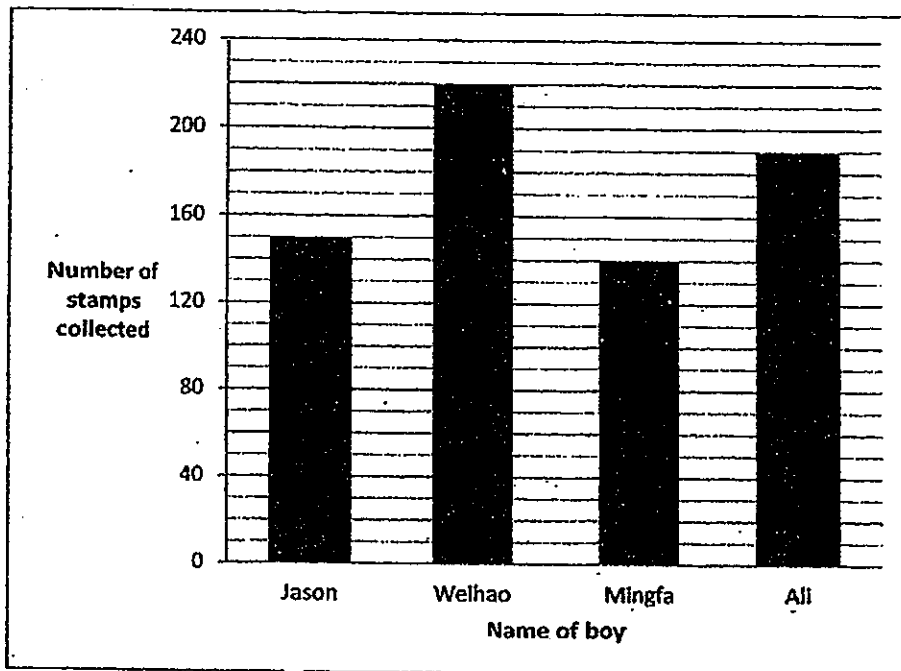

22. What is the total number of stamps collected by the 4 boys?

Ans: _____

23. What is the name of the boy who had collected $\frac{1}{5}$ of the total number of stamps collected by the 4 boys?

Ans: _____

24. The following figure is not drawn to scale. JK is a straight line.
Find $\angle a$.

Do not write
in this space

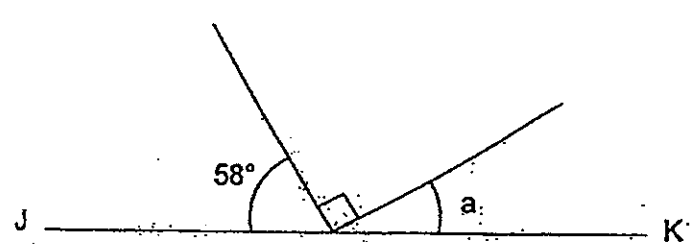

Ans: _____ $^\circ$

25. The length of a skipping rope is 180 cm. What is the total length of 7 such skipping ropes? Give your answer in metres.

Ans: _____ m

Questions 26 to 30 carry 2 marks each. Show your working clearly in the space provided for each question and write your answers in the spaces provided. For each questions which require units, give your answers in the units stated. [10.marks]

26. The table below shows the number of points awarded to a class from July to October. The class has an average of 65 points over 4 months. How many points did the class get in the month of August?

Months	Points
July	64
August	?
September	68
October	75

Ans: _____

Do not write
in this space

27. Mrs Chan wants to buy some muffins from a bakery. The price of the muffins is shown below. What is the most number of muffins Mrs Chan can buy with \$54?

	1 muffin for \$3
	5 muffins for \$12

Ans : _____

Do not write
in this space

28. In a class of 30 pupils, 40% of them were girls and the rest were boys. 2 more boys joined the class. In the end, what percentage of the class were girls?

Ans : _____ %

-
29. A rectangular container measures 20cm by 30cm by 60cm. Find the capacity of the container in litres.

Ans : _____ l

30. Mr Lim wanted to build a fence around his garden as shown below. All the sides of the garden are equal in length. Some poles were placed at an equal spacing of 2 m apart from each other around the garden. How many poles were required to form the fence around the garden?

Do not write
in this space

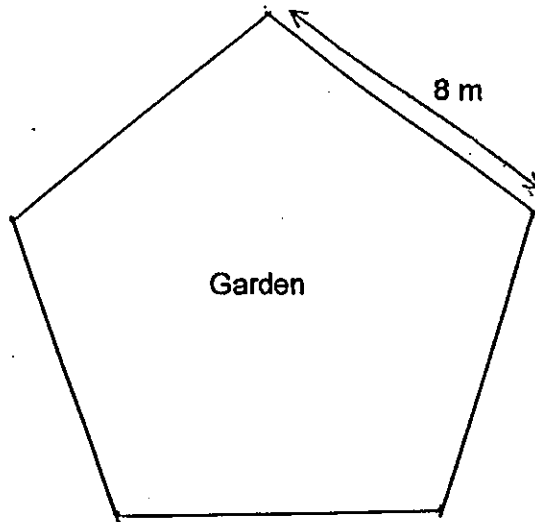

Ans: _____



END OF PAPER



**NAN HUA PRIMARY SCHOOL
SEMESTRAL ASSESSMENT 2 – 2013
PRIMARY 5**

MATHEMATICS

Paper 2

Total Time for Paper 2: 1 hour 40 minutes

5 Short Answer Questions (10 marks)

13 Structured / Long Answer Questions (50 marks)

INSTRUCTION TO CANDIDATES

- 1. Write your name and index number in the space provided.**
- 2. Do not turn over the page until you are told to do so.**
- 3. Follow all instructions carefully**
- 4. Answer all questions and show your workings clearly.**
- 5. You are allowed to use a calculator.**

Marks Obtained

Total		/ 60
--------------	--	-------------

Name : _____)

Class : 5 _____

Date : 28 October 2013

Parent's Signature : _____

Paper 2 (60 marks)

Questions 1 to 5 carry 2 marks each. Show your workings clearly in the space below it and write your answer in the space provided. Give your answers in the units stated.

1. The ratio of John's mass to Samuel's mass is 7 : 9. If Samuel's mass is 63 kg, what is the total mass of John and Samuel?

Do not write in this space

Ans: _____ kg

2. This box is 7 cm long, 4 cm wide 4 cm high.
How many more 1-cm cubes are needed to fill the box?

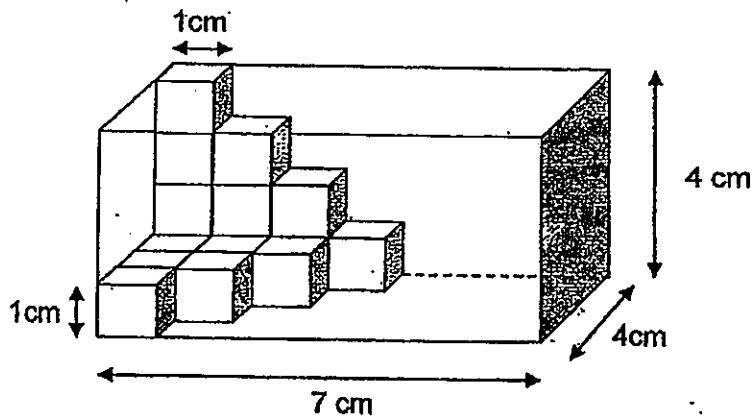

Ans: _____

3. The usual price of a watch is \$360. Henry bought the watch at a discount of 15%. The GST is 7% of the discounted price. How much is the GST?

Do not write
in this space

Ans : \$ _____

4. A rectangular tank, measuring 120cm by 80cm by 40cm, is half-filled with water. There is a crack in the tank and water is leaking out at a rate of 800 ml per minute. How long will it take for all the water to leak out from the tank?

Ans: _____ min

5. AB, CD and EF are 3 straight lines that cross one another at point O. Find the sum of $\angle x$ and $\angle y$.

Do not write
in this space

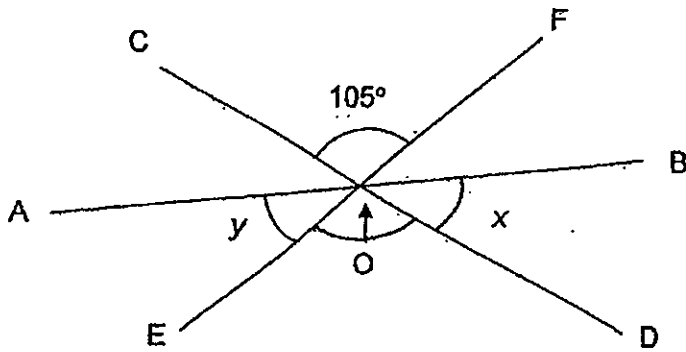

Ans: _____^o

For each question from 6 to 18, show your workings clearly in the space below it and write your answer in the space provided. The number of marks available is shown in brackets [] at the end of each question or part-question. Remember to include the units wherever possible.

6. There were 35 pupils in Miss Lee's class. Miss Lee bought a notebook for each boy and a keychain for each girl in the class for Children's Day. Each keychain cost \$1.20 and each notebook cost \$1.50. Miss Lee spent a total of \$48.30 on the gifts, how many boys were there in her class?

Do not write
in this space

Ans: _____ [3]

7. In a box, $\frac{1}{4}$ of the red marbles is equal to $\frac{2}{5}$ of the blue marbles. If there are 91 marbles in the box, how many red marbles are there?

Ans: _____ [3]

8. Diana wanted to spend all her money on some dresses and blouses. A dress cost four times as much as a blouse. If she bought 5 dresses and 3 blouses, she would not have any money left. If she bought 3 dresses and 5 blouses, she would have \$240 left. How much money did she have at first?

Do not write
in this space

Ans: _____ [3]

9. The table below shows the charges for hiring a taxi.

Metered fare	Charge
1st km	\$3.50
Every subsequent 300 m or thereafter	\$0.22
Morning Peak Hour Surcharge (applicable upon boarding between 6am and 9.30am)	25% of metered fare

Felicia boarded a taxi at 7am for a 12-kilometre trip from her house. How much did she have to pay for the trip?

Ans: _____ [3]

10. The ratio of the number of boys to the number of girls at a funfair was 2 : 7 at first. After 15 girls left, the number of girls became twice the number of boys. How many boys and girls are there at the funfair now?

Do not write
in this space

Ans: _____ [3]

11. 12 girls managed to sell an average of 360 badges for charity. When 6 boys joined them, the average number of badges sold by the children was 310. What was the average number of badges sold by the boys?

Ans: _____ [4]

12. Ryan spent \$35 on a shirt and \$45 on magazines. After that, he spent $\frac{3}{8}$ of his remaining money on 4 identical books. After buying the 4 books, he gave $\frac{3}{10}$ of the money he had left to his mother and saved \$84.

a) How much did each book cost?

b) How much money did he have at first?

Do not write
in this space

Ans: (a) _____ [2]

(b) _____ [2]

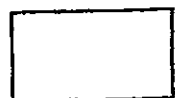

13. The figure below is made up of identical cubes of side 1 cm. (Diagram is not drawn to scale.)

Do not write
in this space

a) Find the volume of the figure below.

b) If Tim were to dip this figure in blue paint, what area of the figure would be painted blue?

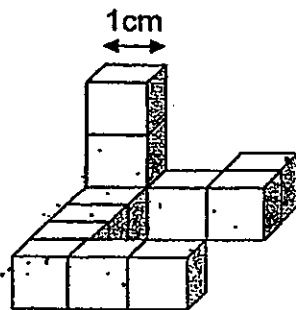

Ans: (a) _____ [2]

(b) _____ [2]



14. Study the diagram below and answer the questions.

Do not write in this space

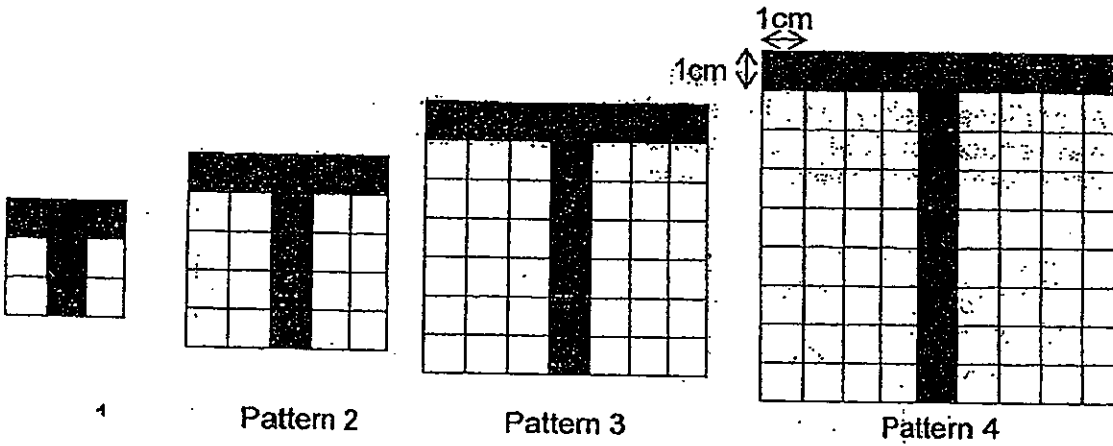

Pattern	Number of shaded squares	No. of unshaded squares
1	5	
2	9	
3	13	
4	17	
5	?	
...
8	?	

- a) (i) How many shaded squares are there in pattern 5?
 (ii) How many shaded squares are there in pattern 8?
- b) How many unshaded squares are there in pattern 12?

Ans: (a)(i) _____ [1]
 (ii) _____ [1]
 (b) _____ [2]

15. The ratio of Fiona's salary to Jessica's salary was 5 : 8 at first. After Fiona's salary was increased by \$200 and Jessica's salary was reduced by \$334 Fiona's salary became the same as Jessica's. What was Fiona's salary in the end?

Do not write
in this space

Ans: _____ [4]



16. A piggy bank can be completely filled with either 75 fifty-cent coins or 120 twenty-cent coins. The piggy bank is now filled with 24 fifty-cent coins and 32 twenty-cent coins.

a) What is the total value of the coins in the piggy bank now?

b) How many more fifty-cent coins can be added to the piggy bank to fill it completely?

Do not write
in this space

Ans: a) _____ [2]

b) _____ [3]

17. 24 identical rectangular tiles are used to tile the floor of a square room. However, the tiles were not enough for the whole room leaving a square in the centre untiled. The length of one side of the room is 2.8 m.

- (a) What is the perimeter of one tile?
(b) What is the total area of the 24 tiles?

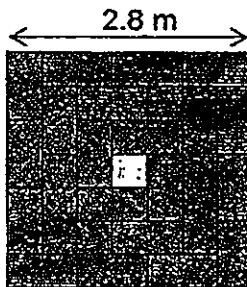

Do not write
in this space

Ans: a) _____ [3]

b) _____ [2]

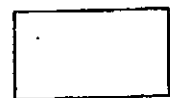

18. In the diagram below, AB and DE are straight lines.
 $\angle m + \angle n + \angle w = 128^\circ$. (Diagram is not drawn to scale.)

a) Find $\angle p$.

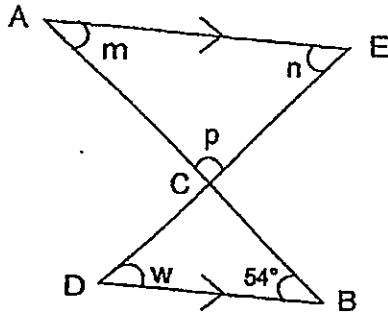

- b) In the diagram below, RST is a right-angled triangle.
 Find $\angle z$. (Diagram is not drawn to scale.)

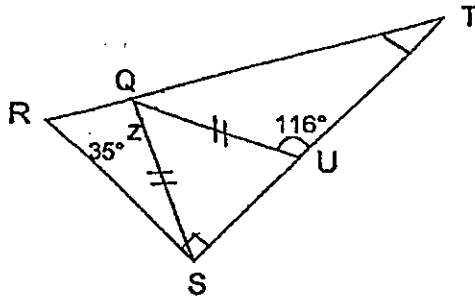

a) _____ [2]

b) _____ [3]

Do not write
in this space



End-of-Paper

ANSWER SHEET

EXAM PAPER 2013

SCHOOL : NAN HUA

SUBJECT : PRIMARY 5 MATHEMATICS

TERM : SA2

Q1	Q2	Q3	Q4	Q5	Q6	Q7	Q8	Q9	Q10	Q11	Q12	Q13	Q14	Q15
2	2	3	1	1	3	1	1	4	4	3	3	2	1	1

16)24

17)20

18)24cm²

19)2 pupils

20)\$200

21)21.49cm

22)700 stamps

23)Mingfa

24)32°

25)12.6m

26)53 points

27)22 muffins

28)37.5%

29)36L

30)20 poles

Paper 2

1)9u → 63kg

$$1u \rightarrow 63 \div 9 = 7$$

$$9 + 7 = 16$$

$$16u \rightarrow 7 \times 16 = 112\text{kg}$$

2)7 x 4 x 4 = 112

$$112 - 16 = 96 \text{ more}$$

3)100% → \$360

$$1\% \rightarrow \$360 \div 100 = \$3.60$$

$$85\% \rightarrow \$3.60 \times 85 = \$306$$

$$\$306 \times 7\% = \$21.42$$

4) $120 \times 80 \times 40 = 384000$
 $384000 \div 2 = 192000$
 $192000 \text{cm}^3 \rightarrow 192\text{L}$
 $800\text{ml} \rightarrow 0.8\text{L}$
 $192 \div 0.8 = 240\text{min}$

5) $360^\circ - (105^\circ \times 2) = 150^\circ$
 $150^\circ \div 2 = 75^\circ$

6) $\$1.20 \times 35 = \42
 $\$48.30 - \$42 = \$6.30$
 $\$1.50 - \$1.20 = \$0.30$
 $\$6.30 \div \$0.30 = 21 \text{ boys}$

7) $13u \rightarrow 91$
 $1u \rightarrow 91 \div 13 = 7$
 $8u \rightarrow 7 \times 8 = 56 \text{ red marbles}$

8) $23 - 17 = 6$
 $6u \rightarrow \$240$
 $1u \rightarrow \$240 \div 6 = \40
 $23u \rightarrow \$40 \times 23 = \920

9) $11 \div 0.3 = 36.666 \approx 37$
 $37 \times \$0.22 = \8.14
 $\$8.14 + \$3.50 = \$11.64$
 $\$11.64 \times 125\% = \14.55

10) $7 - 4 = 3$
 $3u \rightarrow 15$
 $6u \rightarrow 15 \times 2 = 30$

11) $360 \times 12 = 4320$
 $310 \times 18 = 5580$
 $5580 - 4320 = 1260$
 $6 \text{ boys} \rightarrow 1260$
 $1 \text{ boy} \rightarrow 1260 \div 6 = 210$

12) a) $\$18$
b) $\$272$

13)a) $1 \times 1 = 1$
 1 cube $\rightarrow 1\text{cm}^3$
 12 cubes $\rightarrow 1\text{cm}^3 \times 12 = 12\text{cm}^3$

b) 50cm^2

14)a)i) $5 \times 4 + 1 = 21$ shaded squares
 ii) $8 \times 4 + 1 = 33$ shaded squares
 b) $12 + 12 = 24$
 $24 \times 24 = 576$ unshaded squares

15) $8u - 5u = \$334 + \200
 $3u = \$534$
 $1u = \$534 \div 3 = \178
 $5u = \$178 \times 5 = \890
 $\$890 + \$200 = \$1090$

16)a) $24 \times \$0.50 = \12
 $32 \times \$0.20 = \6.40
 $\$12 + \$6.40 = \$18.40$

b) $75 \quad 50c = 120 \quad 20c$
 $0.025 \quad 50c = 1 \quad 20c$
 $20 \quad 50c = 32 \quad 20c$

$20 + 24 = 44$
 $75 - 44 = 31$

17)a) $2.8 \div 7 = 0.4$
 $0.4 \times 2 = 0.8$
 $0.8 + 0.4 = 1.2$
 $1.2 \times 2 = 2.4\text{m}$

b) $0.4 \times 0.8 = 0.32$
 $0.32 \times 24 = 7.68 \text{ m}^2$

18)a) $180^\circ \times 2 = 360^\circ$
 $360^\circ - 54^\circ - 128^\circ = 178^\circ$
 $178^\circ \div 2 = 89^\circ$

b) $180^\circ - 35^\circ - 90^\circ = 55^\circ$
 $180^\circ - 116^\circ = 64^\circ$
 $180^\circ - 64^\circ - 64^\circ = 52^\circ$
 $180^\circ - 116^\circ - 55^\circ = 9^\circ$
 $180^\circ - 52^\circ - 9^\circ = 119^\circ$

