

METHODIST GIRLS' SCHOOL

Founded in 1887



PRIMARY 5 MID-YEAR EXAMINATION 2012 SCIENCE

BOOKLET A

Total Time : 1 hour 45 minutes

INSTRUCTIONS TO CANDIDATES

Do not open the booklet until you are told to do so.
Follow all instructions carefully.
Answer all questions.

Name: _____ ()

Class: Primary 5. _____

Date: 11 May 2012

This booklet consists 19 pages.

Four each question 1 – 30, four options are given. One of them is the correct answer. Make your choice (1, 2, 3 or 4). Shade the correct oval (1, 2, 3 or 4) on the optical answer sheet.
(60 marks)

1. James weighed some leaves and placed it in a box. He caught an insect which is growing at a certain stage of its life cycle. After three hours, he observed that the amount of leaves decreased and the insect was still alive. The graph below shows the changes in mass of the leaves over the three hours.

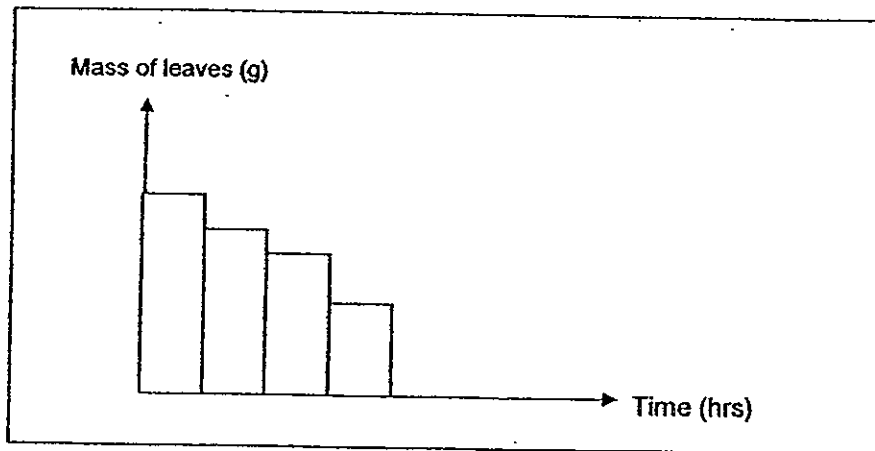

At which stage of its life cycle was the insect when James caught it?

- (1) egg
(2) adult
(3) pupa
(4) larva
2. Which of the following has a life cycle similar to that of a beetle?

- A : dragonfly
B : housefly
C : mosquito
D : grasshopper

- (1) A and B
(2) B and C
(3) A, B and D
(4) A, B, C and D

Go on to the next page

3. Joyce had her lunch at 12 noon. Which of the following shows the correct path that the food goes through her digestive system?

- (1) mouth → stomach → gullet → large intestine
 (2) mouth → gullet → small intestine → large intestine
 (3) mouth → gullet → stomach → small intestine
 (4) mouth → small intestine → stomach → large intestine

4. Below is a list showing the functions of the skeletal system.

- A : It protects the organs.
 B : It gives shape to the body.
 C : It supports the weight of the body.
 D : It works with the muscles to move her legs.

If Nicole broke her left ankle, which of the following function/s of the skeletal system will be affected for a period of time?

- (1) C only
 (2) B and C
 (3) C and D
 (4) B, C and D
5. Study the classification chart below.

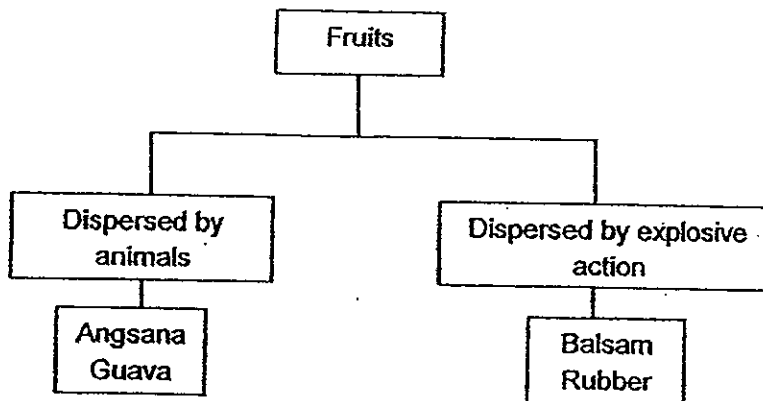

Which of the following fruits are grouped wrongly?

- (1) Guava
 (2) Balsam
 (3) Rubber
 (4) Angsana

Go on to the next page

6. Mei Li wanted to find out which type of soil is suitable for chilli seeds to germinate. What are the variables Mei Li should keep the same?

A : Number of seeds
 B : Type of seeds
 C : Type of soil
 D : Amount of water

- (1) A and C
 (2) B, C and D
 (3) A, B and C
 (4) A, B and D

7. Which of the following correctly describe/s the differences in reproduction in a frog and a human?

	Reproduction in a frog	Reproduction in a human
A	Fertilisation is external	Fertilisation is internal
B	Many eggs are fertilized at one time	Usually one egg is fertilized at one time
C	Young looks like the adult	Young looks like the adult

- (1) A only
 (2) B only
 (3) A and B only
 (4) A, B and C only

8. Which of the following statement/s below about an egg of a human reproductive system is/are true?

A : It is produced by females.
 B : It fuses with the sperm during fertilisation
 C : It is the largest cell in the human body.
 D : It is implanted in the fallopian tube after fertilisation:

- (1) A only
 (2) A and B
 (3) A and D
 (4) A, B and C

Go on to the next page

9. Study the family tree of Mr and Mrs Chan below.

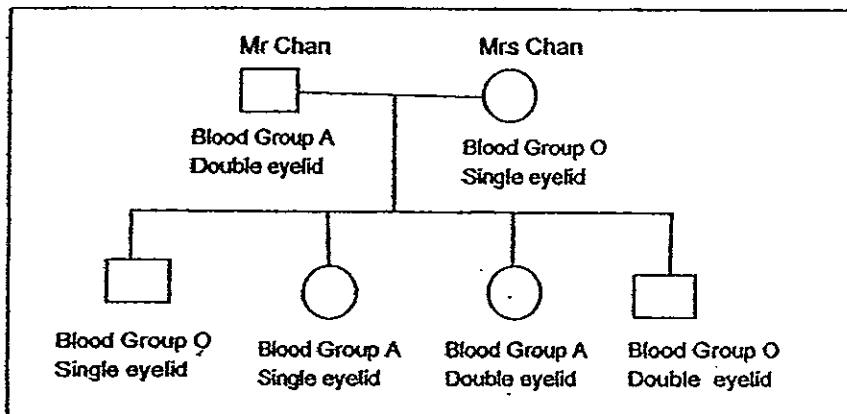

How many of Mr and Mrs Chan's children inherited a trait from each of them?

- (1) 1
 (2) 2
 (3) 3
 (4) 4
10. The table below shows the comparison of sexual reproduction between plants and animals.

Parts of reproductive system	Human	Plant
Female sex cells	Eggs	P
Male sex cells	Q	Pollen grains
After fertilisation	A baby is formed	R

What are the missing information in the above table?

	P	Q	R
(1)	Eggs	Testes	Fruits are formed
(2)	Style	Anther	Seeds are formed
(3)	Ovules	Pollen grains	Fruits are formed
(4)	Eggs	Sperms	Seeds are formed

Go on to the next page

11. While taking a walk along a river, the pupils noticed that there were three types of plants X, Y and Z growing in an area. The diagram below shows part of the area where the plants are.

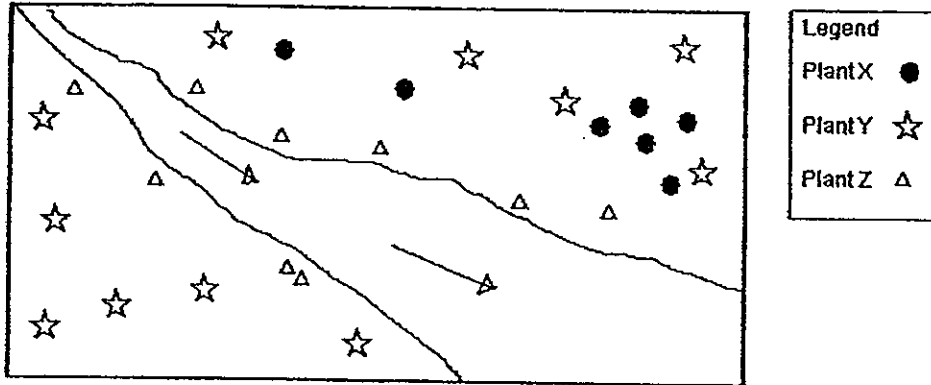

Based on these observations, how are the seeds of the plant likely to be dispersed?

	☆	●	△
(1)	explosive action	wind	water
(2)	animals	explosive action	wind
(3)	animals	wind	water
(4)	wind	explosive action	animals

12. During Science lesson, Megan, Avi, Chris and Nick each received a slide to observe using a microscope. They recorded their observations as shown in the table below:

	Parts of a cell
Megan	cytoplasm, nucleus
Avi	cytoplasm, nucleus, cell wall
Chris	cytoplasm, cell membrane, cell wall
Nick	cell membrane, cytoplasm

Which pupil/s could have observed a plant cell?

- (1) Avi only
- (2) Chris only
- (3) Avi and Chris only
- (4) Megan, Avi, and Chris only

13. The diagrams below show how two organisms reproduce.

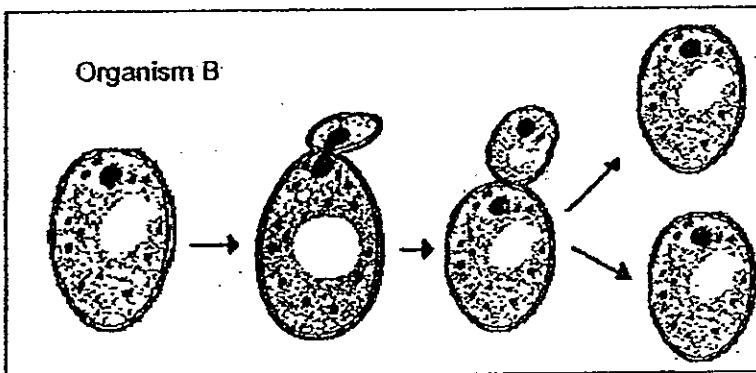
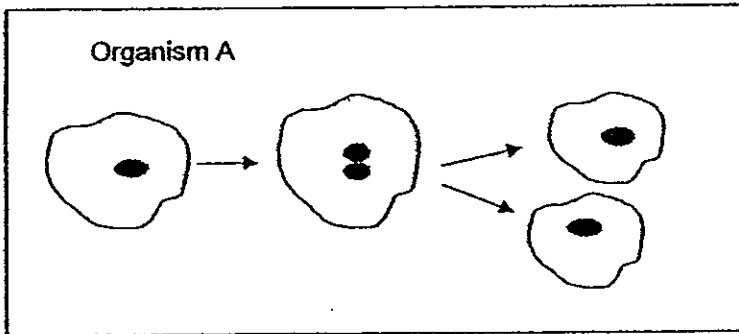

Which of the following describes organism A and B correctly?

- (1) Both organism A and B are unicellular.
- (2) Both organism A and B are multicellular
- (3) Budding has taken place in both organisms.
- (4) Both parent cells are needed to produce a daughter cell.

Go on to the next page

14. The pupils are provided with 8 different flowers as shown in the table below. June wants to find out if the colour of petals will affect an insect's attraction to the flower.

Flower	Smell	Colour of petals	Size of petals
A	sweet smell	white	big
B	no smell	yellow	small
C	sweet smell	red	big
D	no smell	yellow	big
E	no smell	white	small
F	no smell	blue	small
G	sweet smell	yellow	small

Which of the flowers shown in the above table should June use for her experiment?

- (1) B, E and F
 (2) A, B and G
 (3) D, E and F
 (4) E, F and G
15. Which of the following correctly describes the differences between the human and plant transport system?

	Plant Transport System	Human Transport System
1	It transports only mineral salts to other parts of the plant.	It transports oxygen, digested food, carbon dioxide and waste materials.
2	It transports food produced by the leaves away from the leaves.	It transports food which has been digested by the small intestine away from the small intestine.
3	It has a suction pump to push the substances through the tubes.	It has a heart to pump blood through the blood vessels.
4	It has tubes to transport water only.	It does not have any tubes.

Go on to the next page

16. Four pupils, Amy, Brenda, Chris and Denise were given a diagram of a frying pan as shown below.

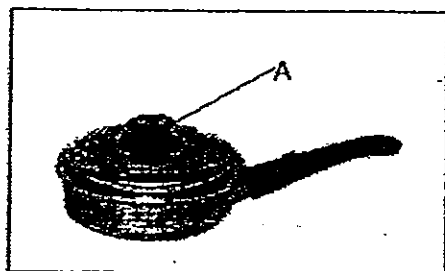

They made the following statements about the part labelled A:

- Amy : It should be plastic because plastic is harder than metal.
 Brenda : It should be metal because metal is stronger than plastic.
 Chris : It should be plastic because plastic is a poor conductor of heat.
 Denise : It should be metal because metal is a good conductor of heat.

Whose statement **best** describes the material chosen for the part labelled A?

- (1) Amy
 (2) Brenda
 (3) Chris
 (4) Denise

17. The table below shows properties of three objects.

Properties	Object X	Object Y	Object Z
It can be scratched with a plastic ruler	X	X	√
If it is hit, it may break into pieces	√	√	X
It is transparent	√	X	X

Which of the following can these objects be?

	Object X	Object Y	Object Z
(1)	Ceramic pot	Glass cup	Paper envelope
(2)	Paper envelope	Glass cup	Ceramic pot
(3)	Paper envelope	Ceramic pot	Glass cup
(4)	Glass cup	Ceramic pot	Paper envelope

Go on to the next page

18. The diagrams below show four communicating vessels.
Which set-up below shows the water level correctly?

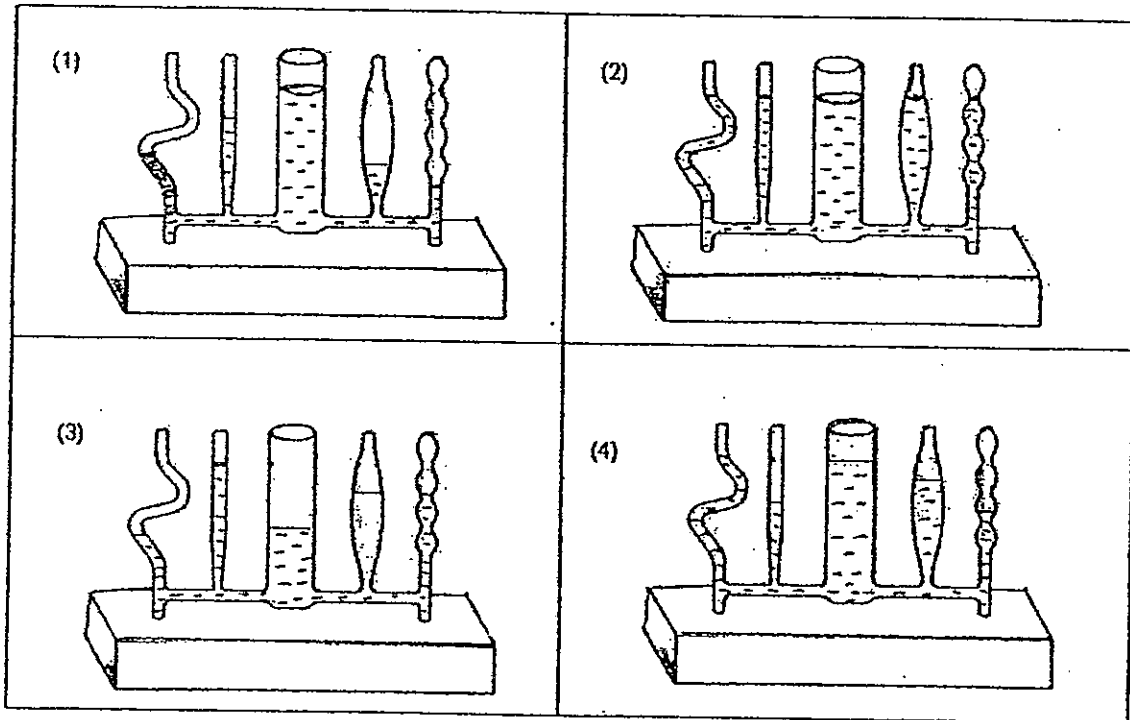

19. Samy wanted to investigate how exposed surface areas would affect the rate of evaporation. He set up four containers, P, Q, R and S made of the same material and placed them under different conditions.

Conditions	P	Q	R	S
Room temperature ($^{\circ}\text{C}$)	30	28	25	28
Exposed surface area (cm^2)	50	150	150	50
Volume of water (cm^3)	300	400	300	400

Which of the following two experiments should Samy use in order for the test to be fair?

- (1) P and Q
- (2) Q and S
- (3) R and S
- (4) P and R

Go on to the next page

20. Jennifer set up an experiment as shown below.

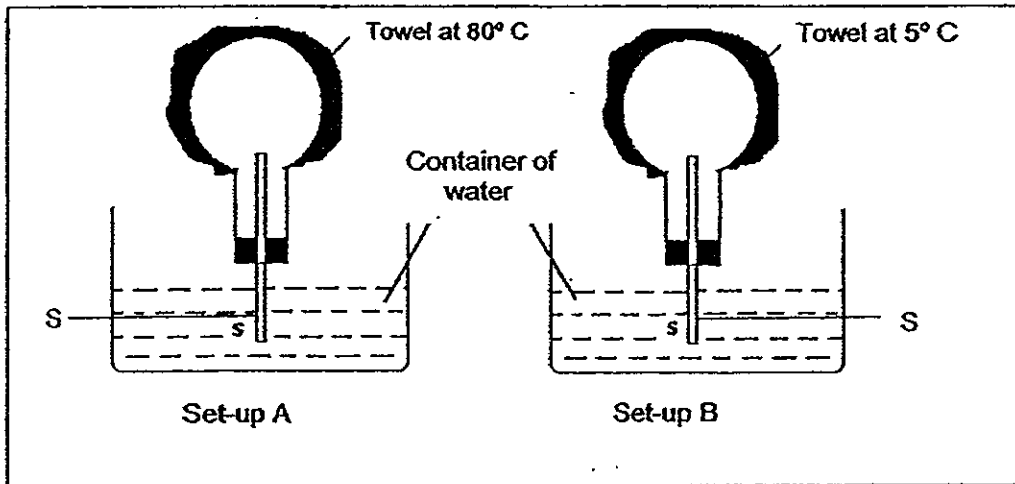

She placed two similar towels of different temperatures on the flask. Which one of the following could be observed five minutes after the towel was placed on the flasks A and B?

	Observation for Flask in Set-up A	Observation for Flask in Set-up B
(1)	Water rises up the tube.	Water rises up the tube.
(2)	Water rises up the tube.	Bubbles escape from tube S.
(3)	Bubbles escape from tube S.	Water rises up the tube.
(4)	Bubbles escape from tube S.	Bubbles escape from tube S.

Go on to the next page

21. Look at the diagram below. What will happen to the volume of air and oil when the plunger is pushed in?

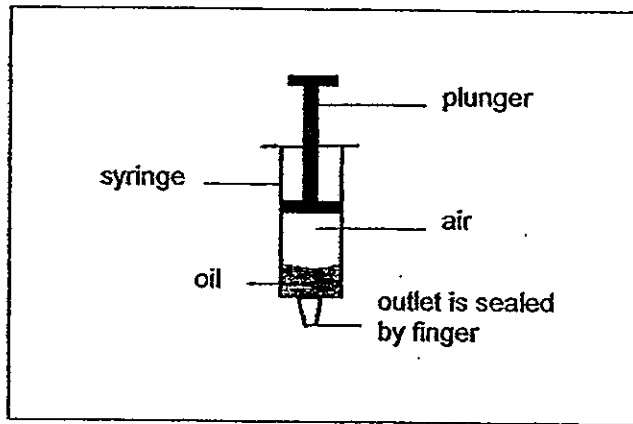

	Volume of air	Volume of oil
(1)	Remains the same	Remains the same
(2)	Remains the same	Becomes smaller
(3)	Decreases	Remains the same
(4)	Decreases	Decreases

22. The diagram below represents the changes in the state of water and the processes involved.

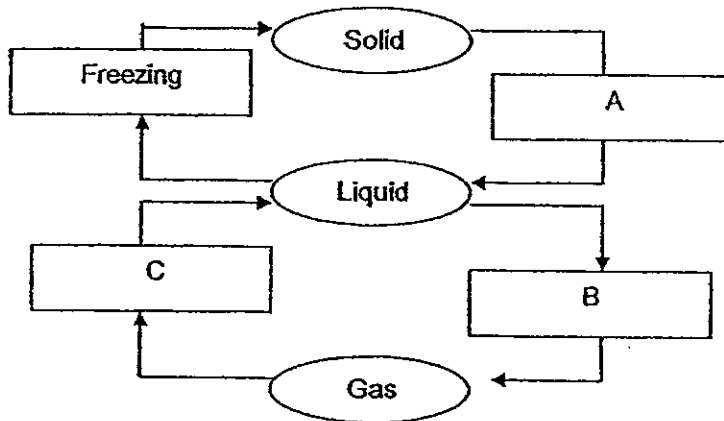

Which one of the following correctly describes A, B and C?

	A	B	C
(1)	Evaporation	Condensation	Melting
(2)	Melting	Evaporation	Condensation
(3)	Melting	Condensation	Evaporation
(4)	Condensation	Melting	Evaporation

Go on to the next page

23. Junie heated a beaker of tap water for 15 minutes until it started to boil. She continued boiling it for another 5 minutes. Which of the following graphs show the changes in the water temperature over 20 minutes correctly?

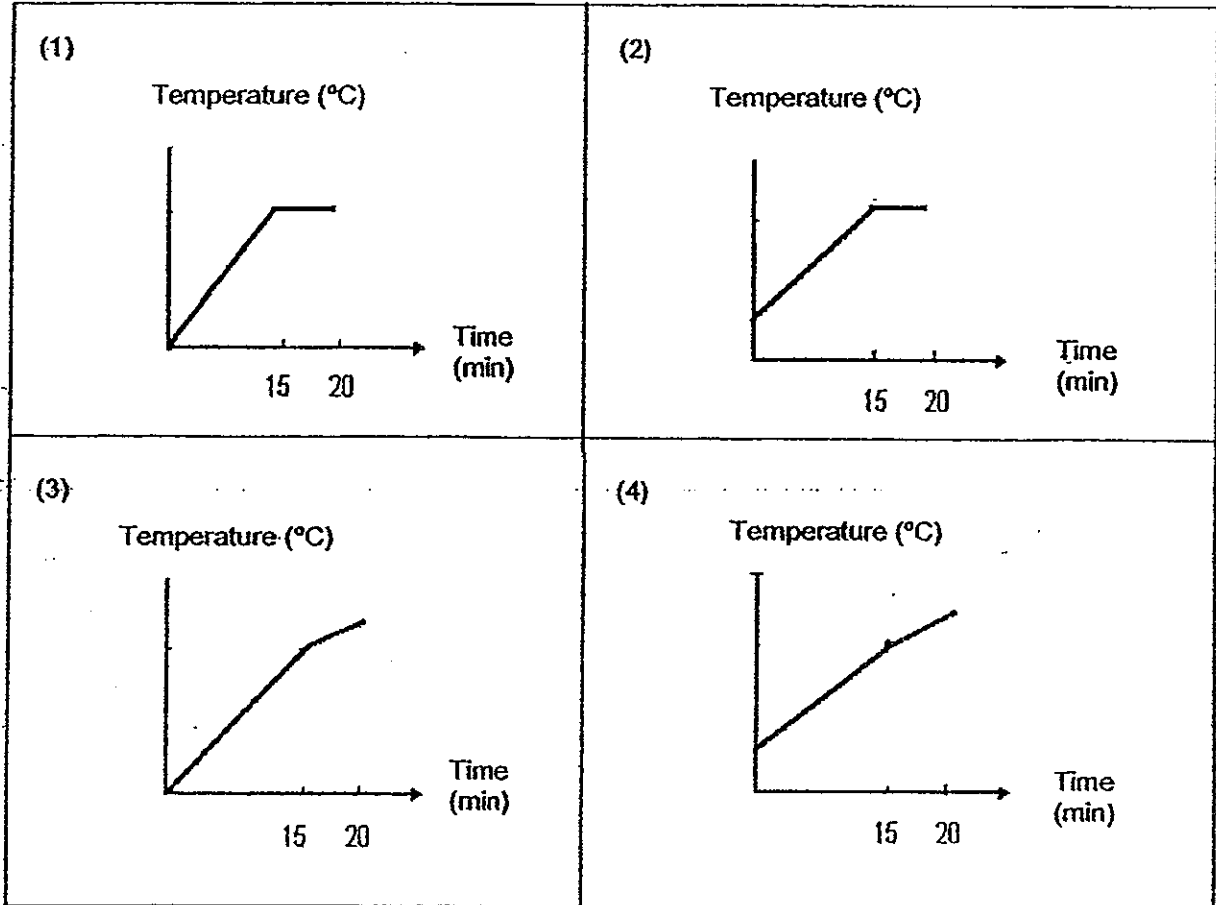

Go on to the next page

24. John conducted an experiment with the following set-up. He noticed that a number of paper clips appear to float above the base of the beaker as shown in the diagram below.

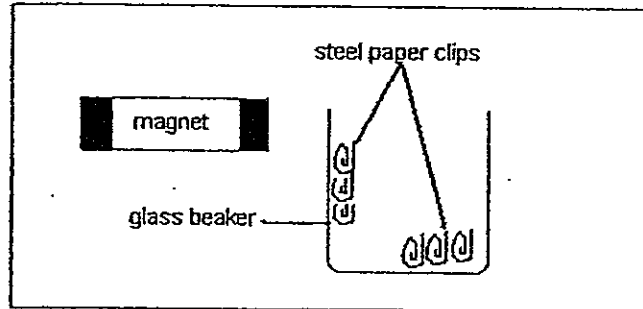

Which of the following could he conclude from the experiment?

- A : The paper clips were attracted to the magnet.
- B : The paper clips were attracted to the beaker.
- C : The magnetic force was able to pass through the beaker.
- D : The paper clips were made of magnetic material and attracted one another

- (1) A only
- (2) A and C only
- (3) B and D only
- (4) C and D only

Go on to the next page

25. The diagrams below show 2 set-ups.

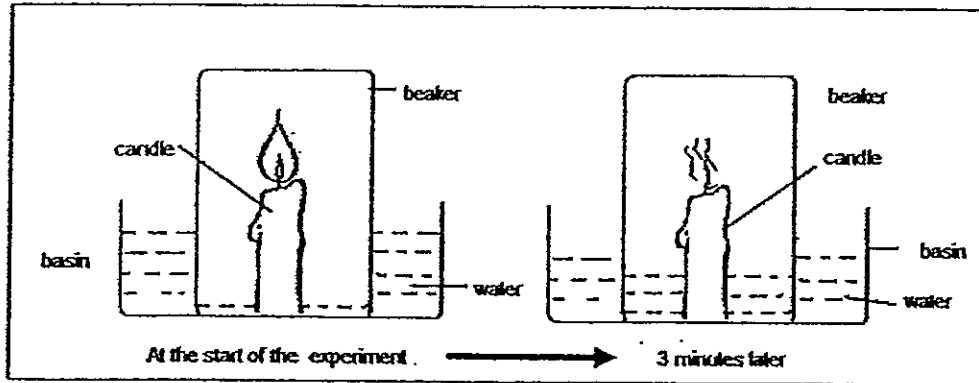

Why does the water level in the beaker rise when the candle goes off?

- (1) The heat from the candle makes the water expand causing the water level to rise.
- (2) The beaker expands on being heated by the candle providing more space for the water level in the basin to rise.
- (3) The oxygen in the beaker is used up when the candle burns providing more space for the water level in the beaker to rise.
- (4) The air in the beaker contracts when the candle stops burning causing an increase in space in the beaker.

Go on to the next page

26. The diagram below shows an electromagnet.

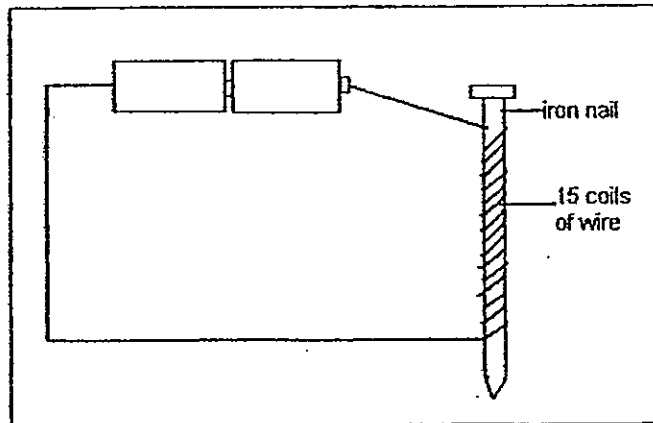

Which of the following electromagnets is/are stronger than the electromagnet above?

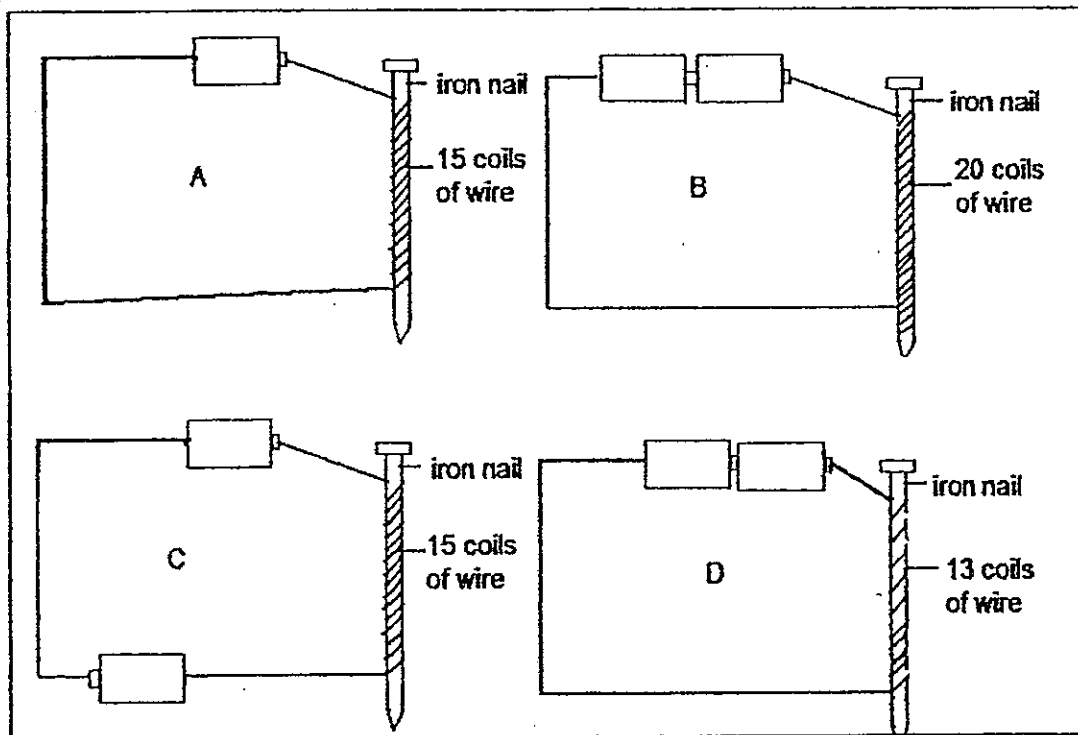

- (1) B only
- (2) C only
- (3) C and D only
- (4) A, B, C and D only

Go on to the next page

27. Sean carried out an experiment to find out which kind of container is best for keeping his food warm. He put the same amount of food into four similar containers made of different materials. The results of his experiment were recorded on the graph shown below.

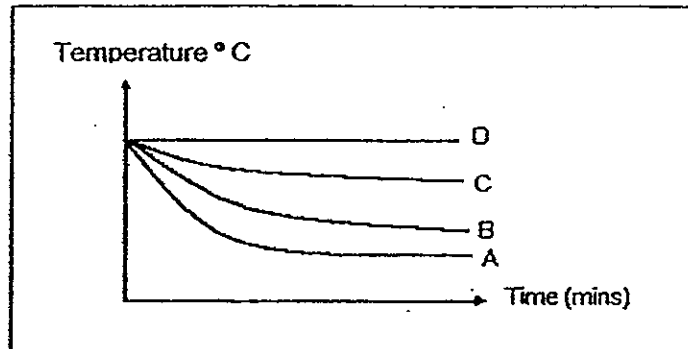

Based on his results, which container, A, B, C or D is best for keeping his food warm for a longer period?

- (1) Container A
 - (2) Container B
 - (3) Container C
 - (4) Container D
28. 2 identical metal balls of different temperature were placed in beakers P and Q respectively.

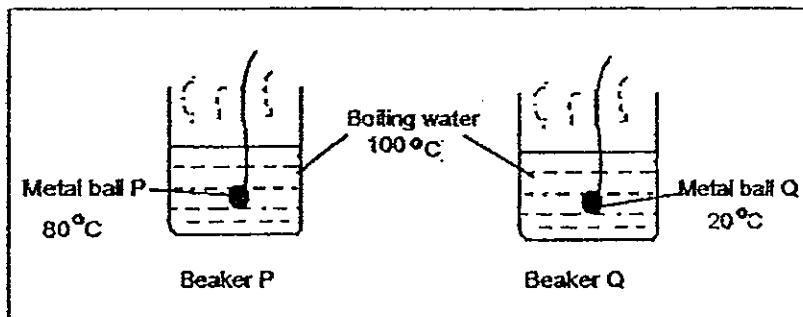

Which of the following statements are correct?

- A : The hot water lost heat to the metal balls.
 B : Both metal balls would expand after a while.
 C : Metal ball P gained heat faster than Metal ball Q.
 D : The water in Beaker P lost heat faster than the water in Beaker Q.

- (1) A and B only.
- (2) B and C only.
- (3) A and D only.
- (4) C and D only.

Go on to the next page

29. Study the classification table carefully.

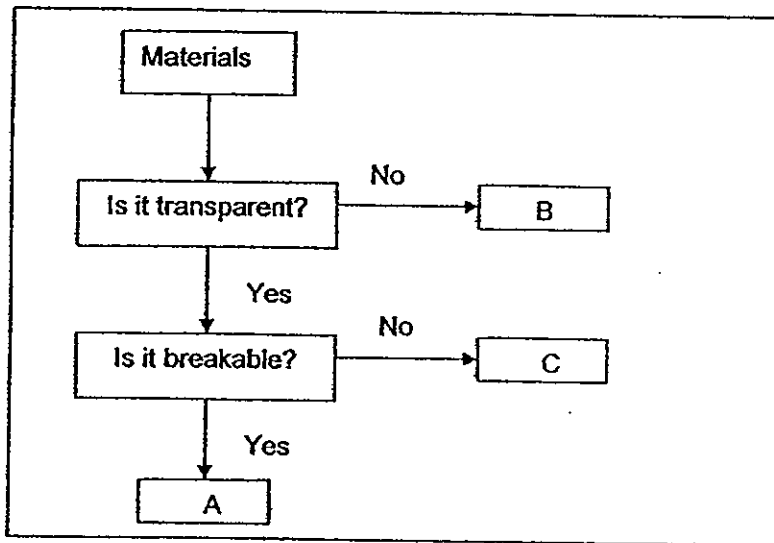

What objects do A, B and C represent in the table below.

	A	B	C
(1)	Plastic raincoat	Glass jar	Wooden ruler
(2)	Glass jar	Plastic raincoat	A book
(3)	A book	Plastic raincoat	Glass jar
(4)	Glass jar	A book	Plastic raincoat

Go on to the next page

30. Derrick placed a stick in his garden. He measured the length of the shadow formed at regular intervals. He then plotted a graph with the measurements. Which one of the following correctly represents the graph that Derrick had plotted?

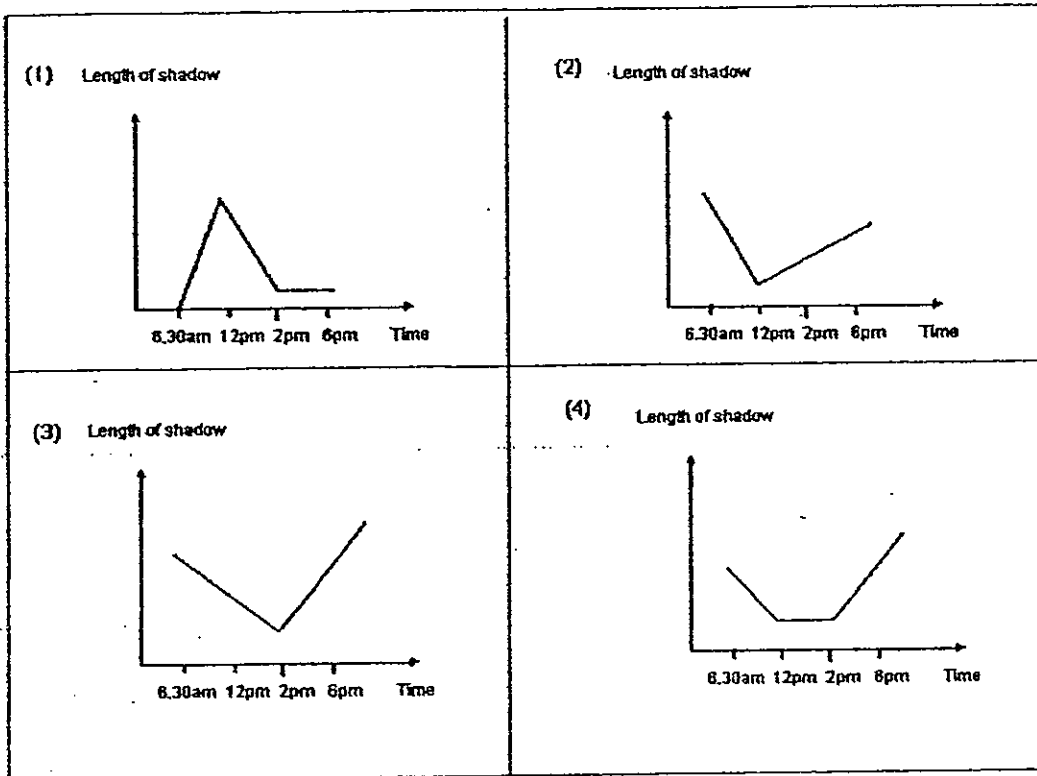

END OF BOOKLET A

METHODIST GIRLS' SCHOOL

Founded in 1887



PRIMARY 5 MID-YEAR EXAMINATION 201:

SCIENCE

BOOKLET B1

Total Time : 1 hour 45 minutes

INSTRUCTIONS TO CANDIDATES

Do not open the booklet until you are told to do so.

Follow all instructions carefully.

Answer all questions.

Name: _____ ()

Class: Primary 5. _____

Date: 11 May 2012

Booklet A	/ 60
Booklet B1	/ 20
Booklet B2	/ 20
TOTAL	/ 100

This booklet consists of 9 printed pages

For questions 31 – 44, write your answers in this booklet.

The number of marks available is shown in brackets () at the end of each question or part question.

(40 marks)

31. One of the methods of reproduction which does not involve fertilization is cloning. In cloning, genes of the parent cells are genetically modified in order to obtain the intended new organism.

a) The diagram below shows the cell that is involved in cloning.

Label the part of the cell involved in this cloning process.

(1m)

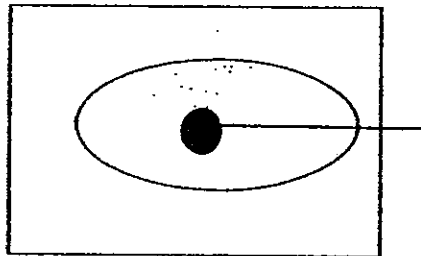

b) Give a reason to support your answer in (a).

(1m)

32. Jane was having a Science lesson on plant cells. She observed a plant cell which has been immersed in a beaker of pure water for two hours under a microscope. After the two hours, she observed that the plant cell has swelled up.

a) Give a reason to explain why the cell ^{the} in beaker A swelled up.

(1m)

b) John carried out another experiment with an animal cell and found that the cell became swollen when it was placed in a beaker of pure water and burst eventually. Explain why the plant cell did not burst while the animal cell burst.

(1 m)

33. The diagram below shows a human baby.

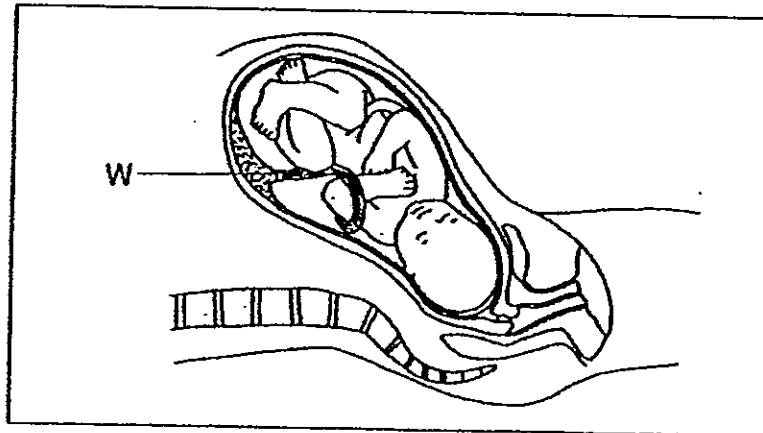

a) What is the function of the part labelled W? (1 m)

b) What happens to the egg after fertilization has occurred? (1 m)

Go on to the next page

34. A scientist genetically modified four new species of berries available in pale yellow, chilli red, light green and orange. An experiment to find out if the colour of the berries will affect the rate of dispersal of their seeds was conducted by the scientist. He placed 40 berries of each colour and three birds in a cage. Then the number of berries left after every 5 minutes was recorded for a period of 30 minutes. The graph below shows the results of the experiment.

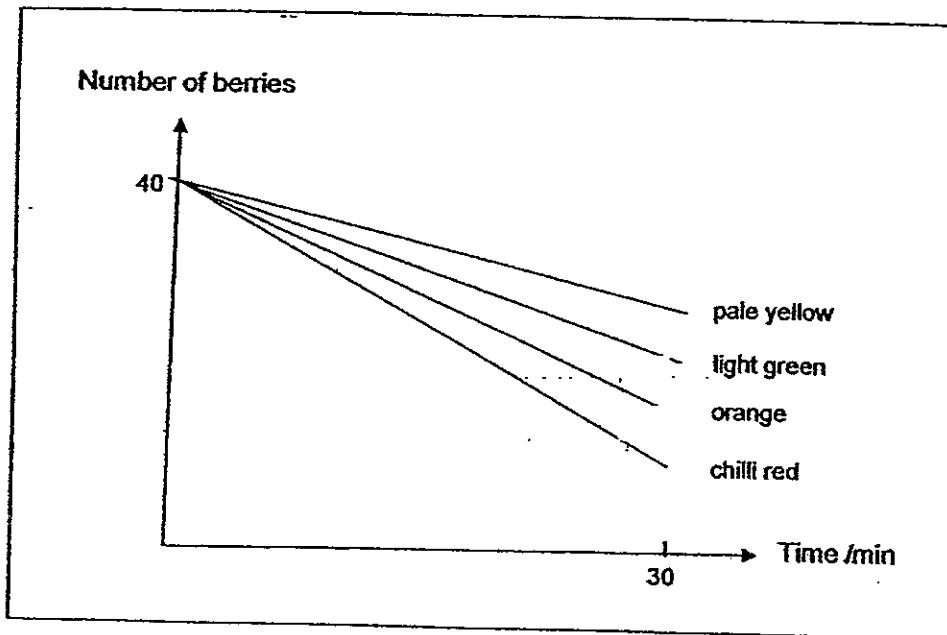

- (a) From the results shown in the graph, state the relationship between the colour of the berries and rate of dispersal. (1m)

- (b) Write down another variable which must be kept the same in order for the experiment to be fair. (1m)

Go on to the next page

35. The graph below shows the volume of air in the lungs when a person breathes.

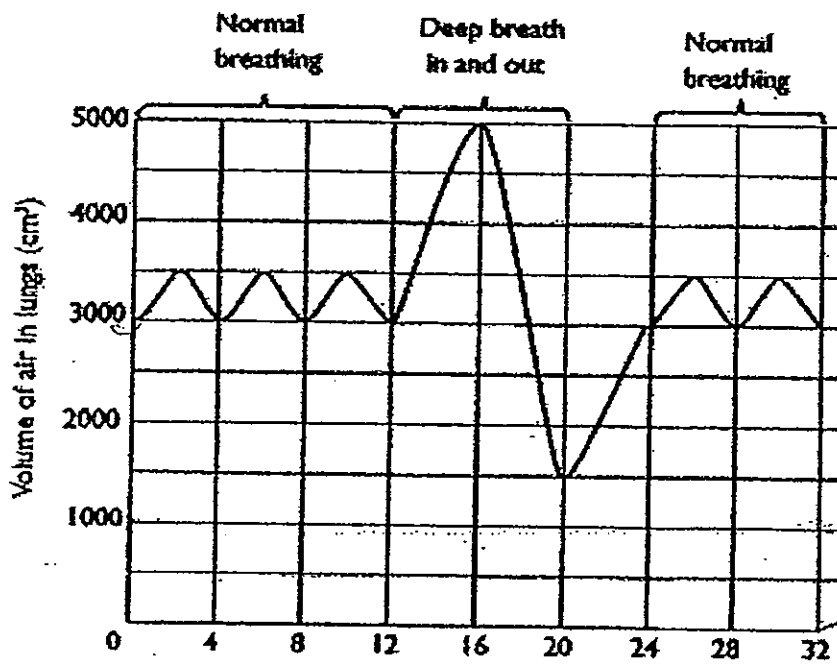

- a) What is the volume of air taken in and out during normal breathing? (1m)
-
- b) What is the difference between respiration and breathing? (1m)
-
-
- c) Explain what happens to the air when it enters lungs. (1m)
-
-

36. Jane placed a balsam plant in a container filled with red-coloured water. After several hours, she cut a cross section of the stem and observed it under the microscope. The cross-section is shown below:

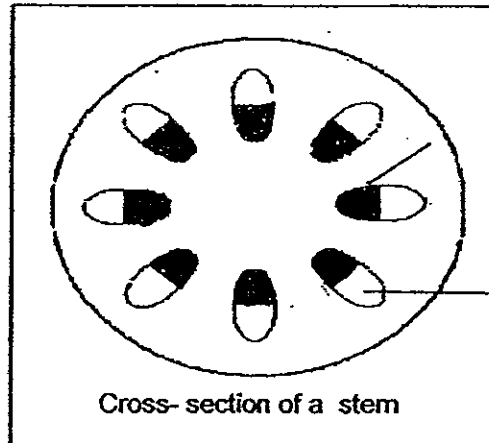

- a) **Shade** the area of the cross-section where Jane would see the red stains. (½m)
- b) **Label** with an "X" the area of the cross section where Jane would expect to find food made by the leaves of the balsam plant. (½m)
- c) Name 2 plant parts where food can be stored. (1m)

- d) Jane wanted to find out what would happen to the plant if she removed a small outer ring of bark from the stem. After few days, she noticed that the part of the bark that was above the ring swelled as shown in the diagram below.

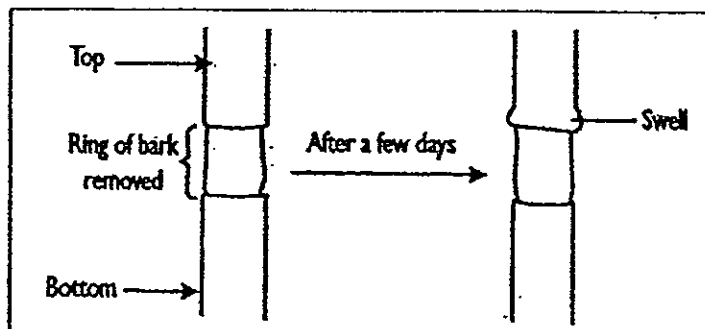

- Give a reason to explain why the swelling occurred. (1m)

Go on to the next page

37. Jenny wanted to investigate the level of oxygen and carbon dioxide present in the water. She set up an experiment as shown below. Then she placed all three set-ups under the sun.

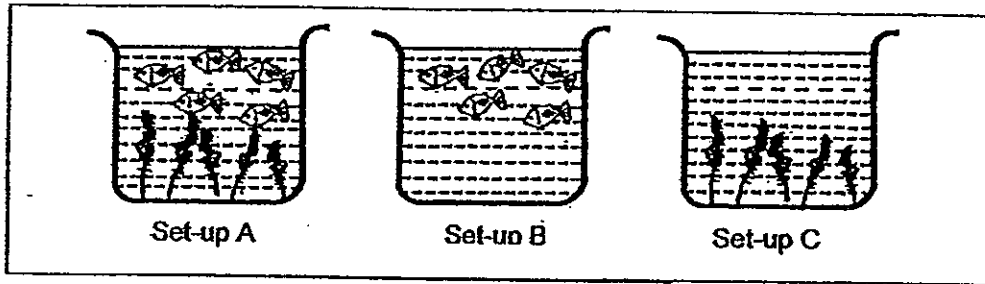

After two hours, she plotted the three graphs to show the level of carbon dioxide in each of the set up.

- (a) In Graph A and B below, draw an unbroken line to show the level of oxygen present in each set-up starting from the point X. Graph C is done for you. (2m)

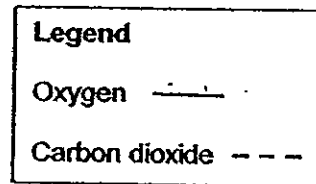

Graph A (Set-up A)

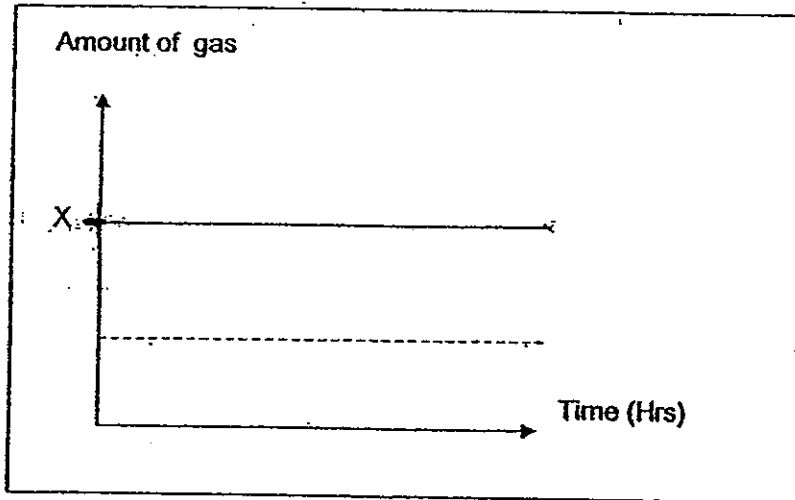

Go on to the next page

Graph B

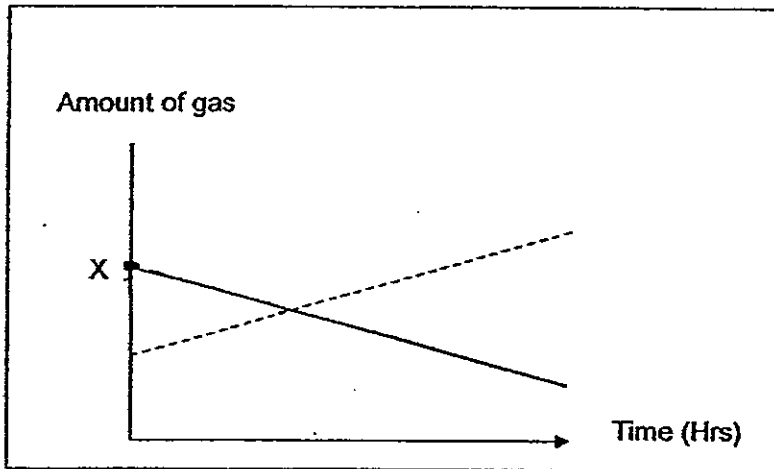

Graph C

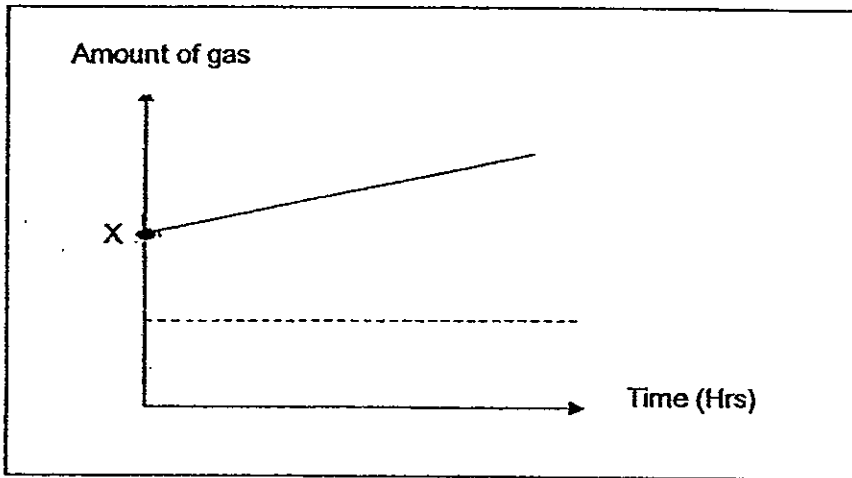

- b) "Since 2000, the company Double A has been helping to preserve the world's forest with its sustainable "Khan-na" concept. The company in Thailand uses strips of empty land between the rice fields called Khan-na, which is where its trees grow." (Straits Times, April 21 2012)

How will growing trees help to improve the quality of inhaled air? Give one advantage. (1m)

38. John examined a section of the leaf under the microscope as seen in the diagram below.

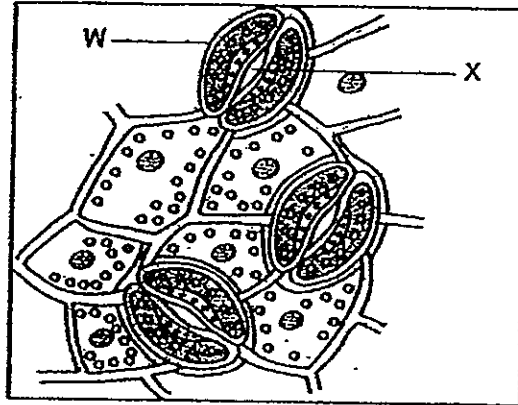

- a) In which part of the plant will the above structure be mostly found? (1m)
-
- b) Which organ in our body performs the same function as Part X? (1m)
-
- c) What is the function of the part labeled W? (1m)
-
-

END OF BOOKLET B1

METHODIST GIRLS' SCHOOL

Founded in 1887



PRIMARY 5 MID-YEAR EXAMINATION 2012 SCIENCE BOOKLET B2

Total Time : 1 hour 45 minutes

INSTRUCTIONS TO CANDIDATES

Do not open the booklet until you are told to do so.
Follow all instructions carefully.
Answer all questions.

Name: _____ ()

Class: Primary 5. _____

Date: 11 May 2012

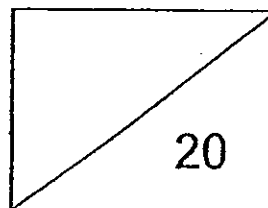

This booklet consists of 9 printed pages.

39. Two similar cans, A and B, contained equal amounts of water. They were left on the kitchen table. Droplets of water were soon observed on the outside of the surface of both cans. The diagrams below show the two cans with droplets of water outside.

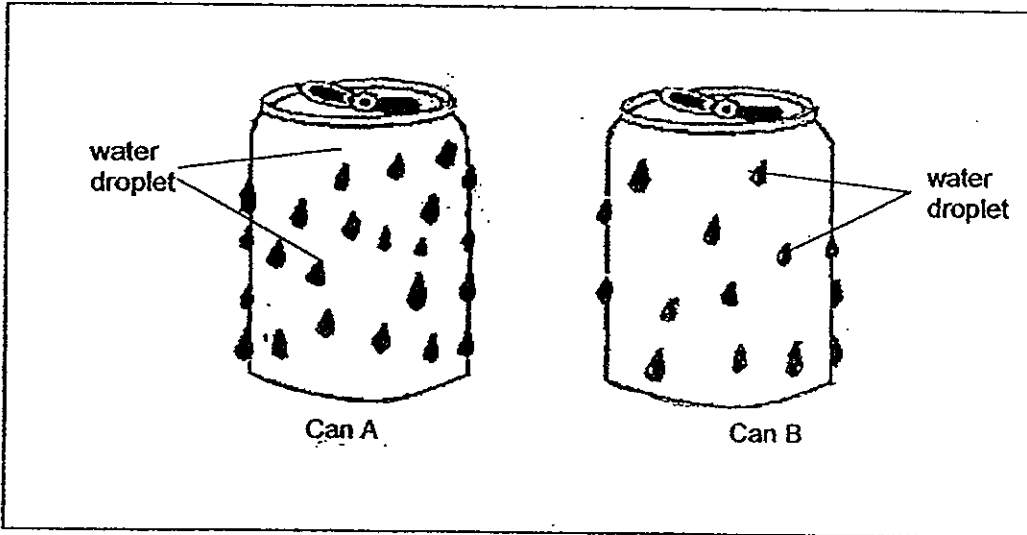

- a) From the observation, explain why there are more water droplets forming on Can A than Can B? (2m)

- b) Explain how the water droplets are formed on the surface of the cans. (1m) (2m)

40. Equal amounts of water were poured into two containers of identical mass. The containers were placed on a scale and they balanced each other as shown in the diagram below.

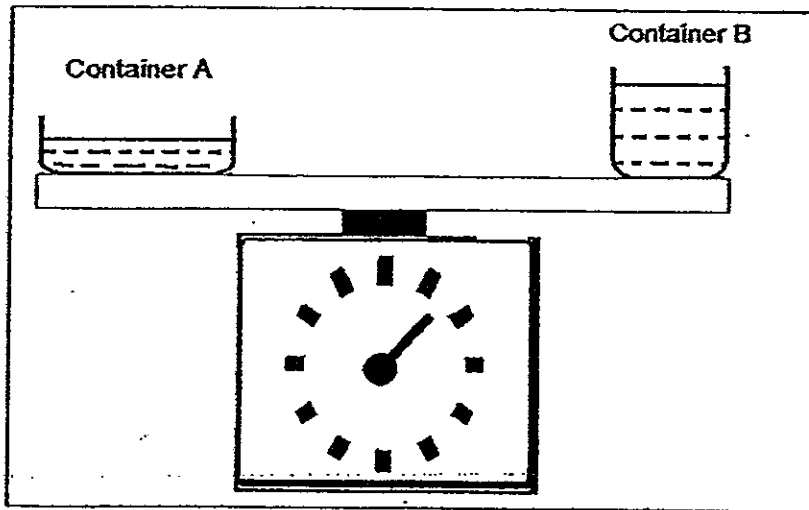

The set-up was left in a windy place. After one hour, one of the containers of water was found to be lighter than the other.

- (a) Which container was lighter and support your answer with a reason. (1m)

- (b) Would the result of the experiment be the same if the set-ups were placed in a non-windy place? Why? (1m)

Go on to the next page

41. The diagram below shows an iron rod. Its ends are labelled A and B. An ice cube is placed at the end labelled A.

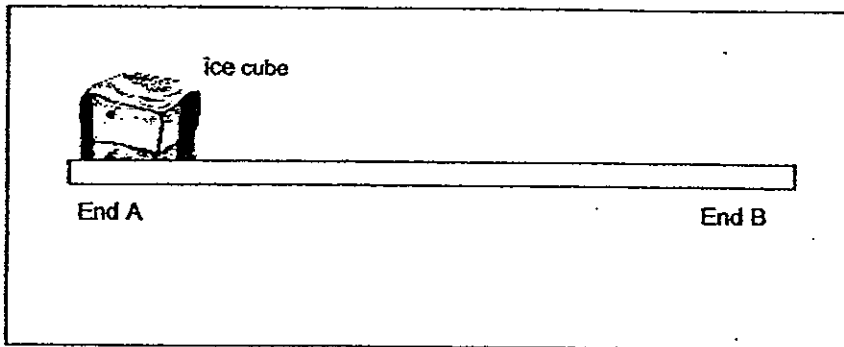

- a) Explain how the ice cube at End A can cool End B after some time? (1m)

- b) The iron rod gets colder after some time. Besides getting colder, state another change that has taken place in the iron rod.

Go on to the next page

42. Mandy used a light sensor attached to a datalogger to measure the amount of light that passes through a sheet of paper.

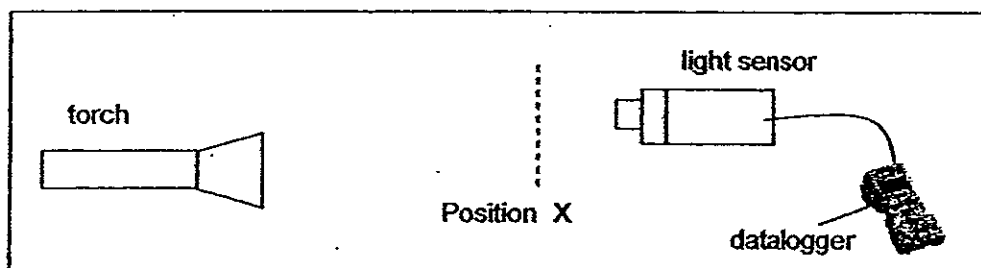

- a) She observed that when nothing was placed at Position X, the light sensor showed a reading of 80 units. However, when a sheet of paper was placed at Position X, the light sensor showed a reading of 32 units. Give a reason for her observation. (1m)

Mandy repeated the experiment by increasing the number of sheets of paper of the same type. The table below shows her results.

Number of sheets	Amount of light (units)
0	80
1	32
2	13
3	5
4	1
5	0
6	0
7	0

- b) Give a reason why her set-up cannot be used to count more than 5 sheets of paper? (1m)

- c) Using the same apparatus, what can Mandy do to her set-up to allow her to count up to 7 sheets of paper? (1m)

43. A fish farmer introduced some fish into three different rivers. He kept track of the number of fish he had introduced into the river for five years. The fish survived in fresh water and the line graph below shows his results.

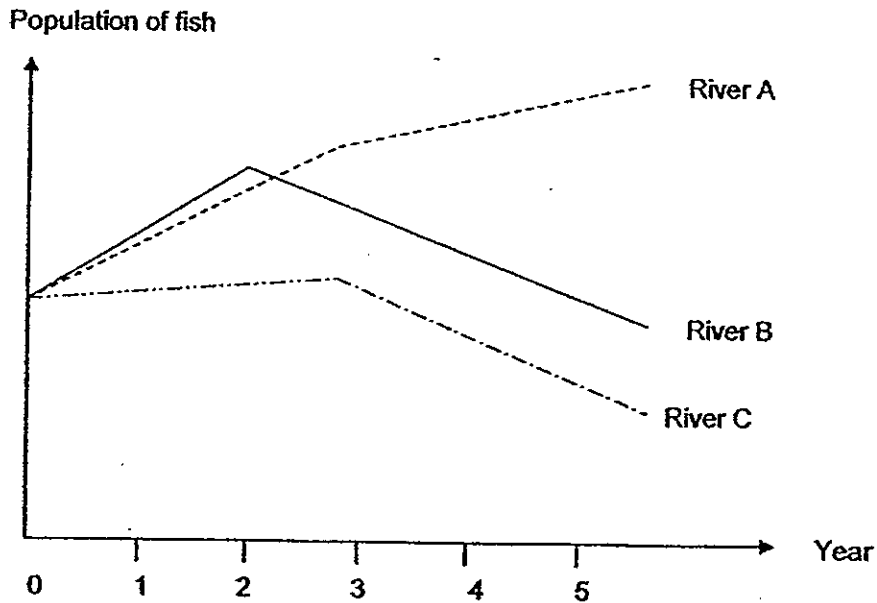

- a) In which river / s did the population of fish decrease and give a reason for the decrease. (1m)

A factory was built near one of the rivers in the second year and released chemical waste into this river.

- b) Which river was the chemical waste released into? Support your answer with a reason. (2m)

Go on to the next page

44. Jude carried out the following experiment. She clamped a magnet onto a retort stand and tied a 20 cm string with a metal clip onto a bench. She observed that the metal clip floated in the air as shown in the diagram below.

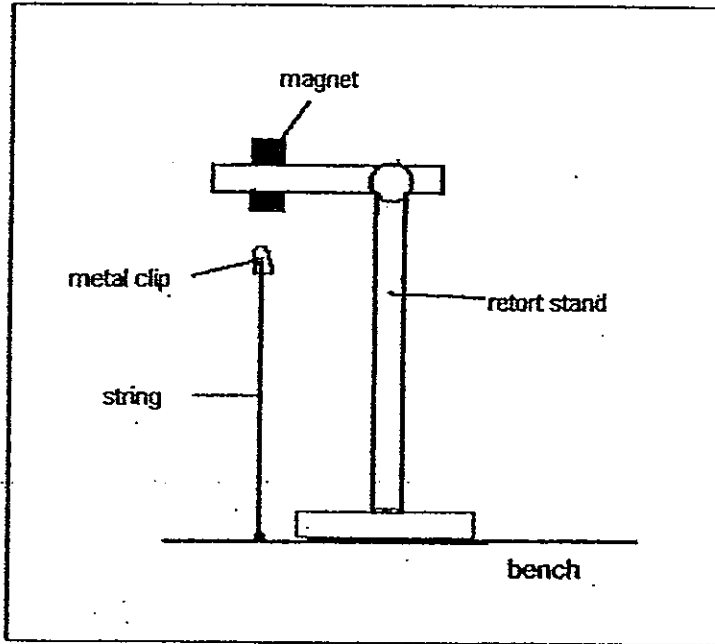

- a) Give a reason why the metal clip did not drop. (1m)

Jude then heated the magnet for about 20 minutes and she noticed that the metal clip could not stay up in the air anymore.

- b) Why was the metal clip not able to stay up in the air after the magnet was heated? (1m)

- c) What can Jude do to make the metal clip float in the air again without adjusting the retort stand and the magnet? (1m)

Go on to the next page

45. Jennifer placed 4 pieces of different materials in a tray of water as shown in the diagram below.

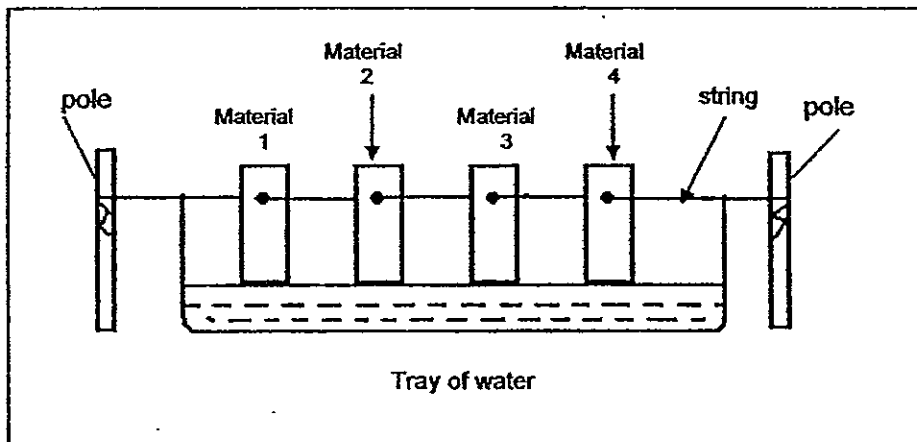

She measured the height of the water level absorbed by the materials on Day 2. The results recorded are shown below.

Height of water level (mm)		
Material	Day 1	Day 2
1	0	10
2	0	27
3	0	32
4	0	3

- a) Which property of material was Jennifer testing in the above experiment? (1m)

- b) If Jennifer wants to select a material to make a shopping bag, which material would she choose and why? (1m)

Go on to the next page

46. Bala set up the experiment as shown below.

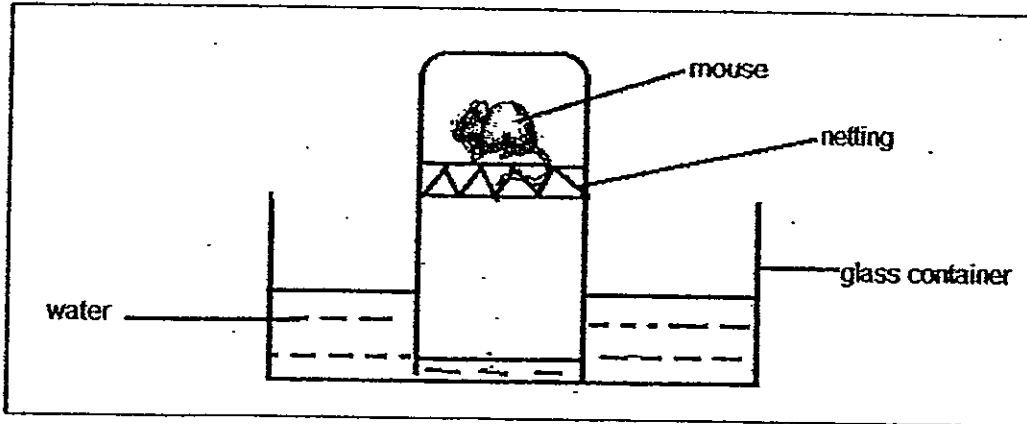

a) What will Bala observe about the water level after 24 hours? (1m)

b) Explain what happened in (a). (1m)

END OF BOOKLET B2



Methodist Girls' School
Semestral Assessment 1 – 2012
Answer Key for P5 Science

1)	4	6)	4	11)	3	16)	3	21)	3	26)	1
2)	2	7)	3	12)	3	17)	4	22)	2	27)	4
3)	3	8)	4	13)	1	18)	2	23)	2	28)	1
4)	3	9)	2	14)	1	19)	2	24)	2	29)	4
5)	4	10)	4	15)	2	20)	3	25)	3	30)	2

31. (a) Nucleus

(b) It contains genetic information that can be passed down from one generation to another generation, so you have to clone the nucleus so that the new cell will be identical to the parent cells.

32. (a) It had absorbed a lot of water in the beaker causing it to swell up.

(b) It has a cell wall to withstand the pressure exerted by the water whereas an animal cell does not have a cell wall.

33. (a) It transports food, oxygen and water from the mother to the baby. It also transports carbon dioxide and waste materials from the baby.

(b) It starts to divide to form more cells.

34. (a) The darker the colour of the berries, the higher the rate of dispersal.

(b) The size of the four new species of berries.

35. (a) 500 cm^3

(b) Breathing takes place in the respiratory system only whereas respiration takes place in all the cells in the body.

(c) Oxygen from the air sacs travels into the blood vessels and carbon dioxide moves from the blood vessels into the air sacs. There is an exchange of gases between the air sacs and blood vessels.

36. (a/b)

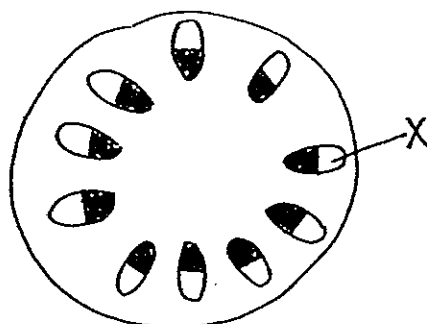

cross-section of a stem

(c) The roots and stem.

(d) the food made by the leaves had to be transported to all parts of the plant through the phloem and since phloem was removed, the food could not get to the bottom of the plant, so the top part would swell.

37. (a) Graph A

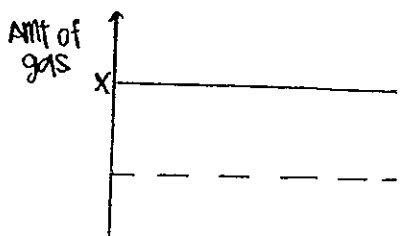

Graph B

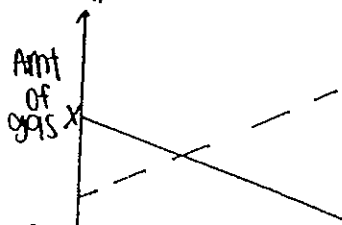

Graph C

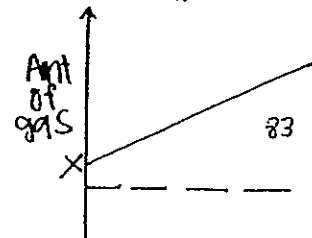

(b) Trees give out oxygen when they photosynthesis and thus increase the level of oxygen in the air.

38. (a) On the underside of the leaves.

(b) Lungs

(c) Controls the opening and closing of the stomata.

39. (a) The water in Can A is cooler than the water in Can B, so more water droplets will form on Can A.

(b) The water vapour from the surrounding air comes into contact with the colder surface of the can, condensing into water droplets.

40. (a) Container A. It has a larger surface area exposed to the surroundings than B.

(b) No, the results will differ/not the same as the rate of evaporation will be slower, so there will be slightly more water in the container as compared to A.

41. (a) The iron rod loses heat to the ice and cools the rod, so end B will become cold too.

(b) It will contract and become shorter.

42. (a) The sheet of paper is probably made of a translucent material blocking some of the light from the torch.

(b) When 5 sheets of paper are put together, it becomes opaque and does not allow light to pass through to reach the light sensor, so, 0 reading recorded.

(c) She can place the torch nearer to position X.

43. (a) River C & B. The rivers had probably been polluted after some times.

(b) River B as the number of fish decreased immediately after the 2nd year.

44. (a) The magnetic force was strong enough to attract the metal clip.

(b) The magnet had lost all its magnetism after it was heated, so it was unable to attract the metal clip.

(c) Jude could lengthen the string so that the metal clip is closer to the magnet.

45. (a) Which material is most absorbent.

(b) Material 4 as it is the least absorbent and will not get wet easily.

46. (a) The water level in the glass container will decrease whereas the water level in the container that mouse is in will rise.

(b) There is a limited supply of air in the container that the mouse is in. So when the mouse has used up all the oxygen in the container, there is space for the water in the container to enter and rise, occupying the space that was originally occupied by the air. Thus, the water level in the glass container will decrease whereas the water level in the container that the mouse is in will increase.